



Elevating retail display hardware as your trusted partner since 1980.

— CATALOG 19

Kinter[®]

800-323-2389 | kinter.com



Why **Kinter**?

At Kinter, our mission is to make display hardware effortless for retailers.

We deliver a human-focused approach—tell us what you need and when you need it, and we'll work out the logistics to make it happen.

Respect is paramount at Kinter. We treat our employees with respect, they treat our customers with respect and we build long-lasting relationships built on trust and reliability. Our smart, friendly team members listen to your needs and don't stop working until your retail display challenge has been solved.

There's a better way to do business.

Whatever you need. Whenever you need it. One phone call. Problem solved.

“Our approach to business is simple — treat each other and our customers like family. We do whatever it takes to help our customers succeed.” – Paul White



800-323-2389

Worldwide Coverage **and Support**

Kinter proudly offers global product and customer support. It's not just our facilities that span the globe—it's our reputation for quality and our ability to deliver products to meet your project requirements.

No matter where you are or what you need, Kinter can help.

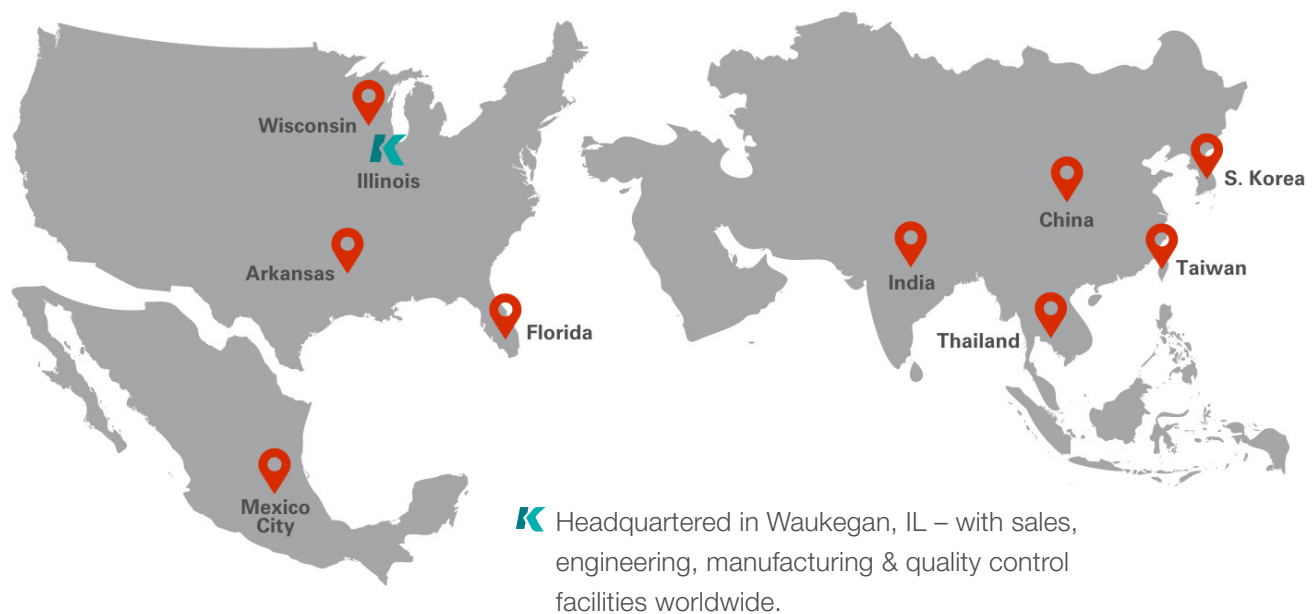

US Locations

- » Arkansas
- » Florida
- » Illinois
- » Wisconsin

Global Locations

- » China
- » India
- » Mexico City
- » South Korea
- » Taiwan
- » Thailand



If You Can Imagine It, **We Can Create It**

In addition to our catalog of products, we are proud to offer the following capabilities to help you meet your retail hardware needs—discovering and designing innovative solutions beyond what you thought possible.

Custom Design, Prototyping, 3-D Printing and Manufacturing

Seeking a custom design? Kinter offers custom design services, manufacturing, and production-ready solutions based on your specific requirements or preferences. Our on-site engineering lab supports custom 3-D printing and prototyping to validate product design, functionality, and performance. From highly detailed and complex designs to simple turnkey solutions, Kinter has the expertise and on-site capabilities to get you what you need, quickly.

“Everyone has the same game plan—to succeed for the customers.” – Garrett Wagner

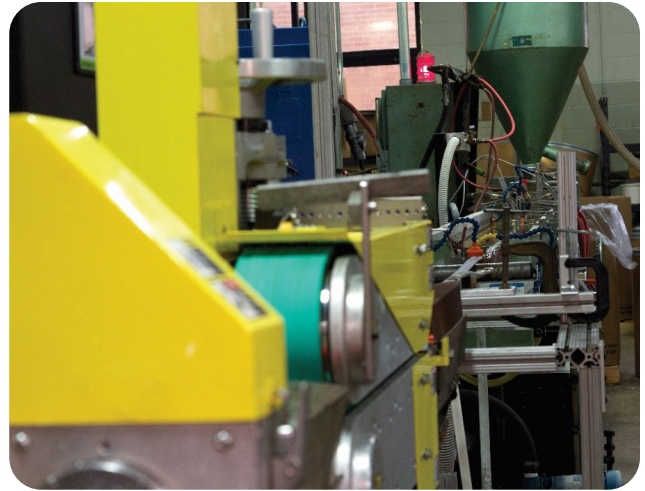

Injection Molding, Custom Extrusion, and Metal Fabrication

At Kinter, we take pride in providing solutions to your retail hardware challenges. Our fully integrated in-house capabilities include:

- » CNC & EDM Tooling
- » Injection Molding
- » Custom Extrusion
- » Material Selection
- » Metal Fabrication
- » Heat Bending

When we say we can 'solve' your retail display hardware problems, we mean it.

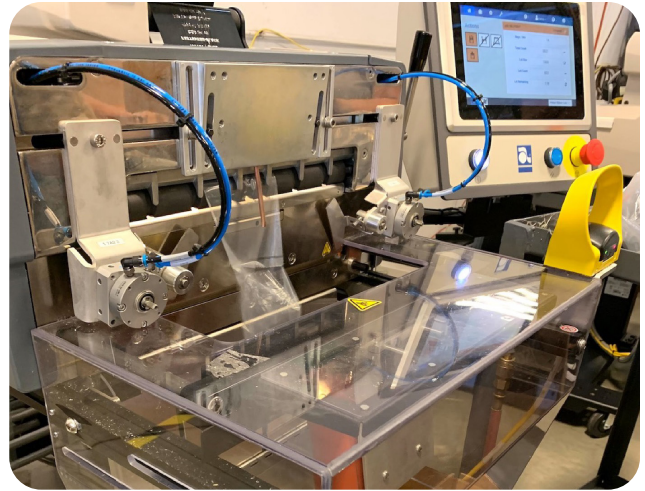

Secondary Operations

Secondary operations always fly under the radar, but at Kinter, we want to ensure our customers know everything we have to offer! Add even greater efficiency to your display hardware acquisition.

In-house fulfillment.

- » High-speed bagging and boxing
- » Labeling and instructions
- » Direct-to-store shipments
- » Co-packing with customer supplied parts

Free Samples

At Kinter, we want to help you make informed decisions when it comes to your retail display hardware needs. That's why we offer free samples.

Our sample rack is stocked with thousands of our most in-demand P.O.P. sign and display hardware items. Whether it's just a couple of items that you need or the entire rack, call 800-323-2389 and we'll ship you what you need for free* today.

** Certain conditions apply*

The Industry's Best Selection of Fasteners

We opened our doors in 1980 as a standard nut and bolt distributor. Today, some of the nation's best-known retailers trust us for overnight shipping on over 30K different standard and specialty fasteners.

Call 800-323-2389 for prompt, expert assistance with all your display hardware needs. And a little Kinter love in every shipment.

- » Anchors
- » Bolts
- » Pins & Keys
- » Nuts
- » Rivets
- » Screws
- » Washers
- » Socket Products



800-323-2389

Company **Timeline**



1980

Where It All Began

Our founders start selling nails out of their garage in Royal Oak, MI.

625 sq. ft



1997

Building Out

Continued growth leads to taking on more space in the Lee Avenue location.

12,500 sq. ft



1985

Movin' On Up

Rapid growth and product line expansion leads to a move — to Lee Avenue in Gurnee, IL.

5,500 sq. ft



2012

Going Bigger

Explosive growth leads us to significantly larger space on Oak Grove Avenue in Waukegan, IL.

115,000 sq. ft



2022

Even Bigger

We are excited to keep growing and expanding our Oak Grove Campus with the addition of our third facility.

300,000+ total sq. ft



2004

Going Big

We build our first warehouse — on Ryan Road in Gurnee, IL.

32,000 sq. ft



2019

New Heights

Six very productive years later, we expanded yet again. We built a second facility next door on Oak Grove Avenue.

200,000+ total sq. ft

Table of Contents

◆ New Products	9–26
◆ Label Solutions	27–48
◆ Display Hooks	49–64
◆ Product Merchandising	65–82
◆ Sign & Literature Holders	83–186
◆ Display Construction	187–224
◆ Rings & Binder Posts	225–234
◆ Ceiling Systems & Accessories	235–264
◆ Cable & Chain	265–274
◆ K-Stick™ Ladderless Sign Hanging System	275–291
◆ Cross-Reference Guide	292–321
◆ Alphabetical Index	322–330
◆ Numerical Index	331–363
◆ Terms & Conditions	364



New Products



Page 31

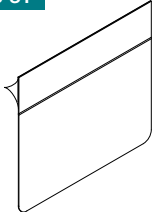

Mini "Stick-On" Tag

Simple "stick-on" tag attaches to the edge or underside of shelves/tables. Just fold along the score line, remove the tape liner and press into place.

- Accepts adhesive labels up to 1-3/8" high and 2" long
- Custom sizes available – please inquire
- 9 mil thick
- Clear rigid PVC



ITEM #	HEIGHT	LENGTH	COLOR
150367	1-3/8"	2"	Clear

Page 33

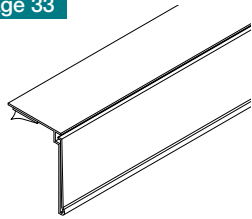

Shelf-Top Adhesive Info Strips

Hang signs over the edges of shelves or other horizontal surfaces – just peel and stick the foam-tape adhesive. Scan codes through the clear facing. Economically hold and protect data tickets, UPC inserts or signs. Change labels easily.

- Accepts 1-1/4" height signs/tags
- "L" top window helps protect from spills
- Other lengths and back colors available – please inquire
- PVC material



ITEM #	LENGTH	TYPE OF BACKING	BACK COLOR
140984B	47-7/8"	Adhesive Top	Black
140984W	47-7/8"	Adhesive Top	White

Page 34

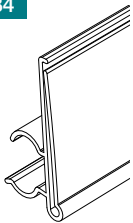

Narrow Double-Wire Shelf Info Strip

Display pricing and promotions on 13/16" height double-wire shelves, sometimes in cooler or freezer cases. Hold and protect data tickets, UPC inserts or signs. Scan codes through the clear facing. Change labels with ease.

- Snaps onto 13/16" height double-wire shelves
- Two label heights to choose from
- Custom lengths and back colors available – please inquire
- PVC material



ITEM #	HEIGHT	LENGTH	BACK COLOR
140933B	1-1/4"	19.5"	Black
140858	1-1/2"	17"	Clear

Info Strip For Glass Shelving

Hold and protect data tickets, UPC inserts or signs on common glass shelves. Friction-fit leg attaches quickly and easily. Scan codes through the clear facing. Change labels with side or top insertion/removal while T-top window helps protect labels from spills.

- Fits glass shelves 1/4" to 3/8" thick
- Accepts labels 1-1/4" height
- Custom lengths available – please inquire
- Durable .038" thick clear PVC

ITEM #	HEIGHT	LENGTH	TYPE OF BACKING	BACK COLOR
140960	1-1/4"	47-7/8"	Slide-On	Clear



Grip-On Gripper Info Strip

Unique info strip with back-to-back grippers – one on the back to grip shelf fences or corrugated edges, and another on the front to hold small signs or tags. Clear front window holds and protects additional labels and data strips. Change labels with ease.

- Back grip capacity is .040"
- Front grip capacity is .025"
- Other back colors and lengths available – please inquire
- PVC material

ITEM #	HEIGHT	LENGTH	BACKING	BACK COLOR
150019B	1-3/8"	28-7/8"	Gripper	Black
150019W	1-3/8"	28-7/8"	Gripper	White

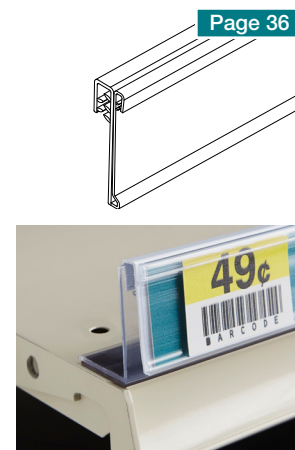

Economy "C" Channel Shelf Molding

A more economical version of our "C" Channel Shelf Molding – with a thinner profile than our standard style – attaching to flat shelving fronts or clean, flat surfaces. Open face design accepts common 1-1/4" tickets, tags or signs. Simply peel adhesive liner and press into place.

- Add pricing/advertisements anywhere with little cost
- 48" length
- Custom lengths and colors available – please inquire
- HIPS material

ITEM #	HEIGHT	COLOR	TYPE OF BACKING TAPE
140940	1-1/4"	White	Transfer Tape
140940B	1-1/4"	Black	Transfer Tape



Double "C" Channel With Holes

Arched "C" channel has two levels, allowing multiple messages to be displayed simultaneously. Hangs off standard 48" shelves using shelf fastener #120450 (sold separately).

- Each track accepts 1-1/4" height signs/tags
- Top track is curved backward for improved visibility
- Other lengths and colors available – please inquire
- White styrene material

ITEM #	STYLE	LENGTH	TYPE OF BACKING	COLOR
140900	2-Track	47-7/8"	Hole-Mounted	White

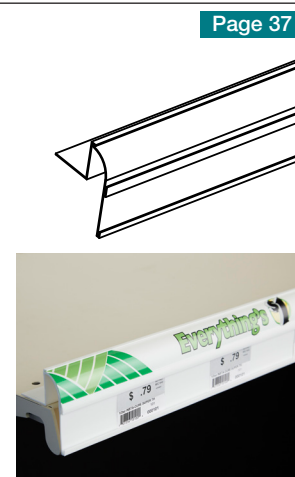

Page 40

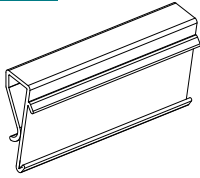

Clip-On "C" Channel Label Holder

Simple clip-on label holder, attaching to the edges of acrylic bins, wire racks, front fences or corrugated displays. Advertisements or info strips slide into the open "C" channel. Clamps securely but removable and reusable.

- Two channel heights to choose from
- Custom lengths available – please inquire
- Durable plastic material



ITEM #	CHANNEL HEIGHT	LENGTH	MATERIAL	COLOR
140925	1"	3"	PVC	Black
150022	1-1/4"	3"	HIPS	Black

Page 40

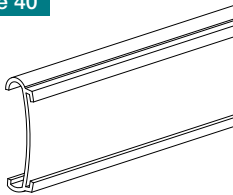

C-Channel for Metro® Shelving

Snaps to the front of Metro® brand wire shelves. Curved, open face design accepts common data tickets, tags or signs.

- Insert common 1-1/4" height signs
- Additional lengths and colors available – please inquire
- Gray or clear PVC material



ITEM #	HEIGHT	LENGTH	COLOR
140962	1-1/4"	3"	Gray
140962C	1-1/4"	3"	Clear
150967C	1-1/4"	44-1/4"	Clear

Page 45

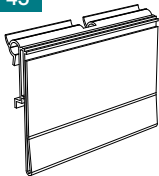

Dual-Purpose Flip-Up Label Holder

Unique label holder with two uses: It attaches to common "C" channel shelving fronts, and also hangs from Kinter's "T-scan" and "scan hook" metal peg hooks (sold separately). Insert and change labels behind the clear window or stick adhesive labels to the front. Flips up for easy access to inventory below and returns to original position.

- Holds labels up to 2" high and 3-1/4" long
- For adhesive or non-adhesive labels
- Custom lengths available – please inquire
- Durable .040" thick material
- Clear PVC



ITEM #	HEIGHT	LENGTH	COLOR
108930	2"	3-1/4"	Clear

Info Strip Gripper Label Holder For Scan Hook

Page 46

Snaps onto common 4-gauge scan hooks (sold separately) with a self-centering hole. Clear window provides a clean appearance while protecting data tickets or UPC inserts. Scan codes through the clear facing or stick adhesive labels to the front. As a bonus, gripper fins along the top edge allow thin signs to be held outside the window.

- Designed to fit common 4-gauge hooks (0.212" to 0.225" dia.)
- For adhesive or non-adhesive labels
- Custom lengths available – please inquire
- Clear PVC material

ITEM #	WIRE SIZE	HEIGHT	LENGTH	COLOR
140871	4 Gauge	1-1/4"	2"	Clear

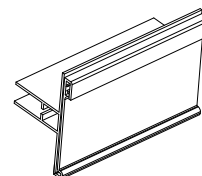

New Products

Heavy-Duty Pegboard Hook Overlay

Page 48

A heavy-duty version of our Pegboard Hook Overlays, converting single-prong hooks into "scan plate" hooks. This heavy-duty style fits our 10" Single Prong All-Wire Pegboard Hooks and our Single Prong Plastic Back Metal Pegboard Hooks (sold separately). Fold the back into a triangular wedge using the tape strip and insert over the hook prongs. Display adhesive labels on the front.

- Fits onto and extends the length of 10" hooks
- Front area holds adhesive labels up to 1-3/8" height x 2-1/8" wide
- Ships flat with minor assembly required
- Other lengths and label sizes available – please inquire
- 13 mil thick, clear rigid PVC material
- Packaged 25 pieces per bag

ITEM #	FITS SINGLE PRONG PEGBOARD HOOKS	STYLE
109650	10" Long	For Adhesive Labels

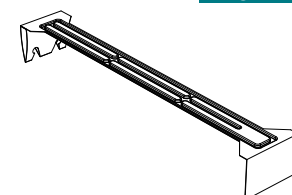

Curl Back Crossbar Hook

Page 54

Sturdy metal hook with welded backplate hangs on 3/16" x 1" crossbars or 1" wire grids. Great for endcap merchandisers, including Kinter's Wire Power Wings #181518 (sold separately). Installs easily with firm stability.

- Curl back design provides friction fit
- Upturn style end with ball tip for safety
- Zinc plated steel material
- Other sizes and finishes available – please inquire

ITEM #	WIRE GAUGE	STEM LENGTH
161402	.149" dia. (9 ga.)	2"

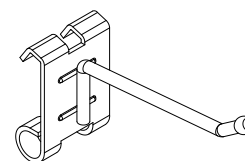

Page 54

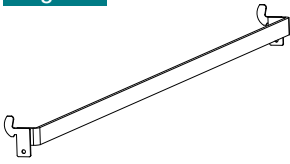

Universal Crossbar

- Use to create 3-dimensional, tiered displays
- Installs into most standard gondola uprights
- Compatible with various crossbar hooks and accessories
- Custom depths available – please inquire



ITEM #	DIMENSIONS	FINISH
180200	1-3/8" Deep x 1" Height x 48" Long	Chrome

Page 63

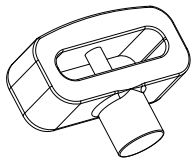

Stop Lock For Loop Hooks

Save money by deterring theft of pegged merchandise. Secure stop lock attaches to common metal loop-style hooks. Controlling inventory is quick and easy with magnetic key #109527 (sold separately).

- Works on loop hooks up to .250" wire
- Overall size is 1.38" height x 1.79" wide
- Bright color provides notice to customers that product is locked and protected

ITEM #	FOR USE ON	COLOR
109626	Loop Hooks	Red



Page 64

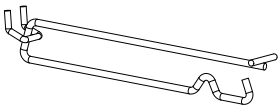

Anti-Sweep Metal Hook With T-Scan Bar

Deter product sweeping with this specialized metal peg hook. It uses a built-in hump and upturn end to allow only one product to be removed at a time. Hang in standard pegboard, and prevent theft/tampering with our Security Peg Back Lock #200009 (sold separately).

- An economical and effective way to enhance loss prevention
- Works as a normal peg hook when single products are removed
- No tools required for installation
- Security Peg Back Lock and label holders sold separately



ITEM #	WIRE GAUGE	STEM LENGTH	FINISH
200026	.212" dia. (4 ga.)	6"	Galvanized
200028	.212" dia. (4 ga.)	8"	Galvanized
200020	.212" dia. (4 ga.)	10"	Galvanized
200009	Security Peg Back Lock	n/a	Galvanized

Take-One Metal Hook With T-Scan Bar

Deter product sweeping with this specialized metal peg hook. It uses a “stop trigger” mechanism to allow only one product to be removed at a time. Hang in standard pegboard using Kinter #107734 Speedy-Back Adapter (sold separately), and prevent theft/tampering with our Security Peg Back Lock #200009 (sold separately).

- An economical and effective way to enhance loss prevention
- Works as a normal peg hook when single products are removed
- No tools required for installation
- Pegboard adapters and label holders sold separately

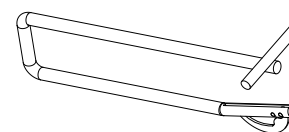

ITEM #	STYLE	WIRE GAUGE	STEM LENGTH	FINISH
200016	Take-One Hook	.212" dia. (4 ga.)	6"	Zinc
200018	Take-One Hook	.212" dia. (4 ga.)	8"	Zinc
200010	Take-One Hook	.212" dia. (4 ga.)	10"	Zinc
107734	Speedy-Back Adapter	.212" dia. (4 ga.)	n/a	Gray
200009	Security Peg Back Lock	n/a	n/a	Galvanized

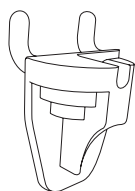

#107734 Speedy-Back Adapter required (sold separately)

Security Peg Back Lock

Connect hooks to standard pegboard to prevent theft or tampering. Simply slide bracket over the hook and secure using the included Heavy Duty Expand-A-Lock (Kinter #120399W). Fasteners expand in pegboard and lock in place.

- Steel security bracket is 1-1/8" wide x 2-1/2" height
- White fasteners included; black fasteners available upon request
- Each sealed polybag contains 25 brackets and 25 fasteners
- Additional fasteners sold separately

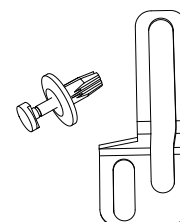

ITEM #	CONTENTS
200009	25 Security Brackets and 25 White Fasteners



Our new, state-of-the-art engineering lab offers expanded capabilities in retail display hardware design, prototype development, and advanced 3D printing.

K-Lock® Security Tethers – Standard Duty

- Deter shoplifters with security tethers for handheld merchandise
- Ideal for electronics, power tools and more
- 1/32" x 36" long nylon coated cable with various end styles (see chart)
- Tethers retract automatically when not pulled
- High-impact plastic boxes measure 1-5/8" length x 1-5/8" width x 5/8" height
- Use the adhesive backing to attach to flat surfaces, or mount to metal shelves using Kinter screw #4N100SPPDZ (sold separately) using the two mounting holes

ITEM #	END STYLE	FUNCTION	BOX COLOR
200030B	Grommet End	Grommet end (0.2" dia. hole) can be screwed or riveted to merchandise	Black
200031B	Loop End	Adjustable loop end (Allen wrench included)	Black
200032B	Collar End	Adjustable loop end with adjustable stop point for tether (Allen wrench included)	Black
200033B	Round End	Firm round end with adhesive (1" dia.) attaches to merchandise	Black
200034B	Flex End	Flexible round end with adhesive (1" dia.) attaches to oddly shaped merchandise	Black
200035B	Ball End	Cable ball tip (0.15" dia.) is an internal locking mechanism for merchandise	Black

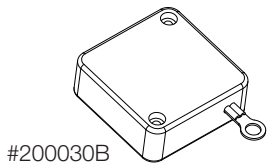

#200030B

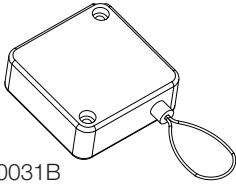

#200031B

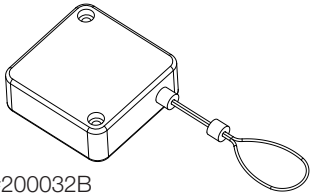

#200032B

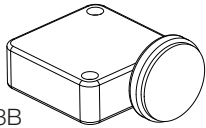

#200033B

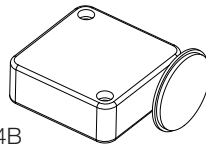

#200034B

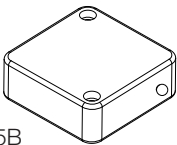

#200035B

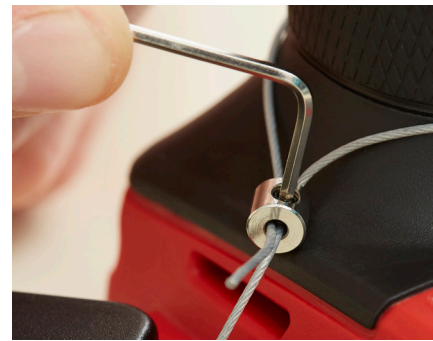
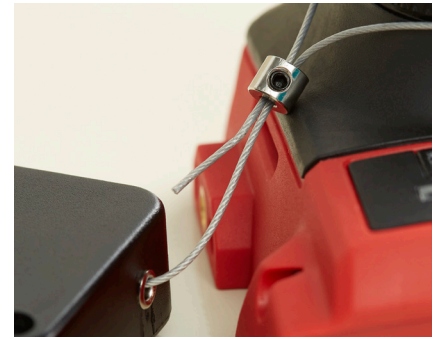

#200030B



#200031B



#200032B



#200033B



#200034B



#200035B



Solid Contoured Shelf Divider

A variation of our Contoured Shelf Divider, but in solid form with no breakaway sections. Simple and inexpensive shelf management system to organize or separate products. Crystal clear divider attaches to standard shelving units (fasteners sold separately).

- Radius corners for safety
- Durable .10" thick wall
- Additional heights or lengths available
- Crystal clear styrene

ITEM #	HEIGHT	LENGTH
150354	3"	14-1/4"

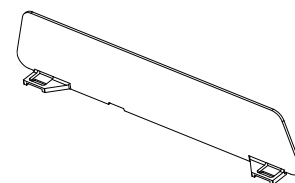

Shelf-Top Metal Merchandising Strips

Similar to our regular Metal Merchandising Strips, but hang directly over perforated shelf tops, with no other hardware needed. Great for displaying heavier items one above the other, especially in high-traffic areas. Steel clips firmly hold products.

- Square-top cane hangs over perforated shelves
- Available with scan plate for stick-on labels, or "C" channel for slide-in labels. Scan plate measures 1-3/8" height x 2-1/8" wide; "C" channel measures 1-1/4" height x 3-1/2" wide
- Sturdy 0.212" dia. steel pole, painted beige
- Available in other lengths or colors – please inquire

ITEM #	STYLE	OVERALL LENGTH	HANGING POSITIONS	COLOR
130209	With Scan Plate	19-3/4"	7	Beige
130221	With "C" Channel	31-3/4"	12	Beige

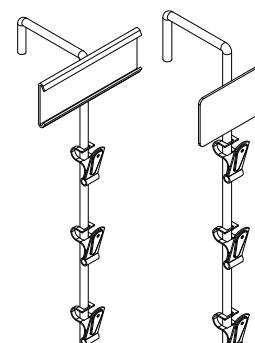

#130221

#130209



#130221



#130209

Three-Level Merchandise Floor Bin

Increase your sales on loose/impulse merchandise using this sturdy, three-level bin. All levels have removable floor grates, allowing taller items to be displayed if desired. Durable yet lightweight enough to be moved or repositioned easily for various promotions. Compatible with several Kinter sign-hanging accessories – please inquire.

- Round bins are 18" diameter and 7-1/2" deep
- 7-1/4" tall opening between levels
- Three square legs with protective plastic caps on the bottom
- Friction-fit assembly with no tools required
- Black painted steel

ITEM #	NUMBER OF BINS	OVERALL HEIGHT	FINISH
180031B	3	46-1/4"	Painted Black

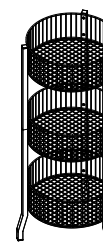

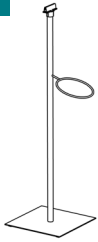

Floral Stand With Bucket Holder

Compact floral stand has a bucket holder to sell fresh flowers (bucket not included). Easily movable to encourage sales at the checkout line or greeting card section. A heavy-duty gripper sign holder is included to display decorative signage on top.

- Circular bucket holder is heavy-duty wire, with an inside diameter of 6-1/2"
- Black gripper top is 3" wide x 1" height, holding signs 0.080" to 0.250" thick
- Four rubber feet attached to the bottom of the base
- Base is 12" x 12" square
- Black painted steel material



ITEM #	OVERALL HEIGHT	BUCKET HOLDER I.D.	FINISH
150406B	41"	6-1/2"	Painted Black

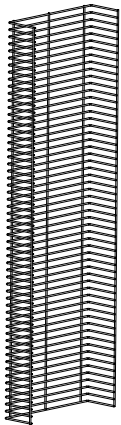

Wire Power Wing

Open a new world of merchandising options on high-visibility end caps. Industry standard "fixed rail" is compatible with numerous Kinter sign-hanging accessories – please inquire. Wire Power Wings mount to the ends of common perforated shelves using hardware kit #181522 (sold separately).

- 57 horizontal wires, spaced 1" outside-to-outside
- Durable 0.164" wire ideal for high-traffic areas
- 181522 mounting kit includes 2 J-clips, 2 screws and 2 wire nuts in a clear polybag
- Custom wire colors available



ITEM #	DESCRIPTION	WIDTH	HEIGHT	DEPTH	COLOR
181518	Wire Power Wing	14.5"	48"	4-1/2"	Beige
181518S	Wire Power Wing	14.5"	48"	4-1/2"	Zinc
181522	J-Clip Hardware Kit	n/a	n/a	n/a	Zinc

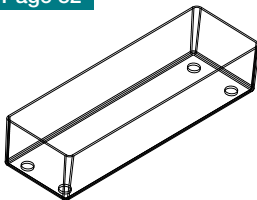

Clear Tabletop Bin

Sturdy rectangular bin attractively holds small items on tables, shelves or counters, with four "no skid" buttons attached to the bottom.

- Holds small items up to 10-1/2" wide
- Deluxe .080" thick walls
- Crystal clear styrene



ITEM #	WIDTH	HEIGHT	DEPTH
150482	11"	2-1/4"	3-1/4"

Opti-Bins & Label Holder

Clear bins hang from standard slatwall, offering easy access to merchandise. Use multiple bins or various sizes to create an attractive, multi-level display. Optional gripper label holder #150968 (sold separately) attaches to the front for adhesive or non-adhesive tags/signs.

- Bins are 6" wide x 5-1/2" high
- Three bin lengths to choose from
- Bins are clear styrene; label holder is clear PVC
- Custom sizes available – please inquire

ITEM #	STYLE	SIZE	FINISH
170966	Slatwall Bin	7-1/2" Long	Clear
170967	Slatwall Bin	9-1/2" Long	Clear
170968	Slatwall Bin	11-1/2" Long	Clear
150968	Label Holder	2" Wide	Clear

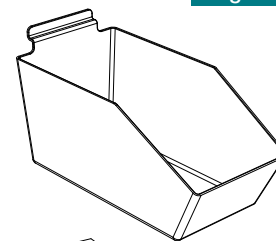

#150968



Vented Bin For Glass

Make an impact on customers – right on the cooler or freezer door. Upsell or cross-merchandise your products on glass. Great for selling ketchup, chocolate syrup, soft drinks and more. Four high-quality Kinter suction cups (included) ensure a firm hold.

- Bin features 16" of usable length
- Features a flat label area 2" height x 16-1/2" wide for optional pricing
- Four Kinter suction cups (#130604) are included, inserting into four keyholes
- Durable, clear polycarbonate material

ITEM #	WIDTH	BACK HEIGHT	DEPTH
150960	18-3/8"	6"	4-1/2"

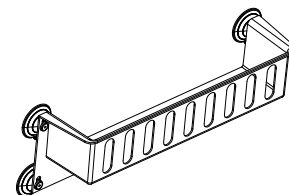

Synthetic Wicker Basket

- Attractive synthetic wicker basket enhances product display
- Wire reinforced with double-wrapped edges
- Other sizes and colors available – please inquire

ITEM #	SIZE	COLOR
180029	16" Long x 12" Wide x 2-1/2" Deep	Brown



Page 88

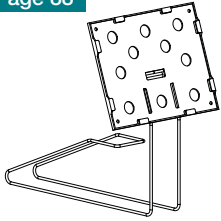

Universal Pallet Floor Sign Holders

Display promotional signs or pricing information for pallet-stacked merchandise. Simply slide the flexible wire foot into any side of a standard pallet. Signs are elevated approximately 8" off the floor and tilted backward for optimal viewing. Durable for indoor or outdoor use.

- One case includes the components for 10 complete sets: 10 metal bases, 10 sign frames and 40 sign pins (Kinter #120451B, four per frame)
- Sign pins hold graphics firmly in windy conditions
- Pins can be removed and reused, but additional pins can be purchased separately if necessary
- Wire foot is black painted steel; sign base is durable black plastic
- Custom frame sizes/colors available – please inquire
- Sold in full cases only



ITEM #	SIGN SIZE	COLOR
150464B	5" tall x 7" wide	Black
150465B	7" tall x 11" wide	Black
150466B	8-1/2" tall x 11" wide	Black

Page 106

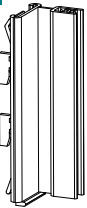

Gondola Upright "Offset" Gripper Sign Holder

A variation of our traditional Gondola Upright Gripper Sign Holder. Here, the grippers are "offset" to one side, not centered. Ideal for end cap displays. Gripper fins hold signs in vertical (flag) position. Use two or more holders for larger signs. Sold unassembled.

- Base fits most standard gondola uprights
- Grippers are 3" long x 3/4" wide base
- Grippers are clear PVC material
- Base is white ABS material
- Gripper portion can be used on other Kinter bases – please inquire



ITEM #	STYLE	GRIP CAPACITY
106306	With Hinge	up to .100"
106309	With Hinge	.100 to .250"

Page 108

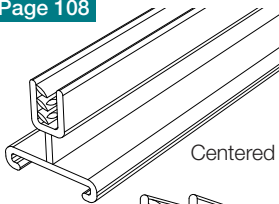

Slide-On Gripper Sign Holders

Compatible with numerous Kinter brackets to create your custom sign holder.

- Slide-on (wraparound) legs make parts removable and reusable
- Available with or without hinge (Hinge allows signs to flex when bumped)
- Available with centered gripper or offset gripper
- Custom lengths available – please inquire
- Clear PVC material



ITEM #	LENGTH	STYLE	GRIP CAPACITY	POSITION
116101	3"	With Hinge	up to .100"	Centered
116102	3"	With Hinge	.100" to .250"	Centered
116103	3"	No Hinge	up to .100"	Centered
116104	3"	No Hinge	.100" to .250"	Centered
116106	3"	With Hinge	up to .100"	Offset Style
116109	3"	With Hinge	.100" to .250"	Offset Style



Shelf-Top Bracket

Fits most perforated shelves.

- Face plate measures 3" height x 3/4" wide
- Compatible with Kinter's slide-on grippers and other adhesive sign holders
- ABS material

ITEM #	COLOR
116400	Beige
116400B	Black

Page 108

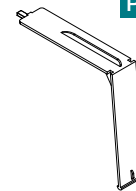

Metal Shelf-Top Bracket

Fits most standard perforated shelves.

- Face plate measures 15/16" height x 3/4" wide, with a 3/16" diameter hole
- Compatible with Kinter's slide-on grippers and other adhesive sign holders
- Steel material

ITEM #	COLOR
116800	Beige

Page 108

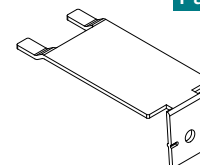

"C" Clamp Bracket

Attaches to most shelves or table edges using turn screw with rubber stopper (included).

- Fits shelves or other fixtures up to 2-1/2" thick
- 3" height x 3/4" wide x 2" deep "C" clamp size with two 3/16" dia. mounting holes
- Steel material

ITEM #	FINISH
106930	Zinc plated

Page 109

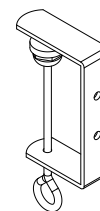

Channel Mount Bracket

Fits most 1-1/4" height shelf channels, with combo machine screw included.

- Face plate measures 3" height x 3/4" wide
- Compatible with Kinter's slide-on grippers and other adhesive sign holders
- ABS material

ITEM #	COLOR
116600	Beige

Page 109

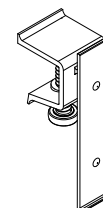

Page 109

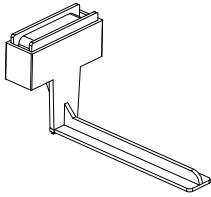

Magnetic Under-Shelf Bracket – L-Style

Fits securely underneath metal shelves with heavy-duty magnet.

- Face plate measures 4" length x 3/4" wide
- Compatible with Kinter's slide-on grippers and other adhesive sign holders
- ABS material

ITEM #	COLOR
116970	Beige
116970B	Black

Page 110

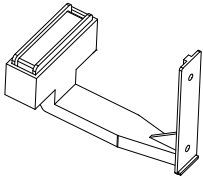

Magnetic Under-Shelf Bracket

Fits securely underneath metal shelves with heavy-duty magnet.

- Face plate measures 3" height x 3/4" wide
- Compatible with Kinter's slide-on grippers and other adhesive sign holders
- ABS material

ITEM #	COLOR
116960	Beige
116960B	Black

Page 110

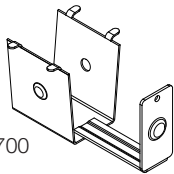

#116700

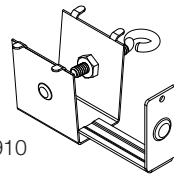

#116910



Under-Shelf Bracket

Fits most perforated shelves, with two mounting styles to choose from.

- Face plate measures 1-9/16" height x 3/4" wide
- Compatible with Kinter's slide-on grippers and other adhesive sign holders
- Steel material

ITEM #	STYLE	COLOR
116700	Spring-Mount	Beige
116910	Screw-Mount	Beige

Under-Shelf Hardware-Mount Bracket

Fits most perforated shelves using wing nuts & bolts (included).

- Face plate measures 1-3/4" height x 3/4" wide, with two 1/4" diameter mounting holes that are 1-1/4" on center
- Compatible with Kinter's slide-on grippers and other adhesive sign holders
- Steel material

ITEM #	COLOR
116940	Beige

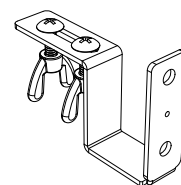

Metal Telescopic Bracket

Compatible with Kinter's slide-on grippers and other adhesive sign holders.

- Telescoping arm adjusts from 13" to 21" long in 1" increments
- Face plate measures 3" height x 3/4" wide, with one 3/16" diameter hole
- Steel material

ITEM #	FOR USE ON	COLOR
116900	Gondola Uprights (w/ Zinc-Plated Flip Nut Insert)	Beige
116900B	Gondola Uprights (w/ Zinc-Plated Flip Nut Insert)	Black
116990	Gondola Uprights (Tool-Free Style – No Flip Nut)	Beige
116920	Pegboard	Beige
116920B	Pegboard	Black

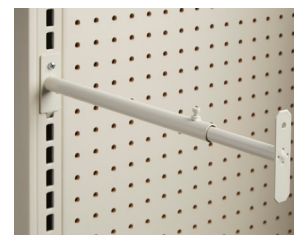
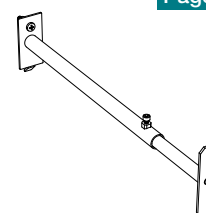

#116900

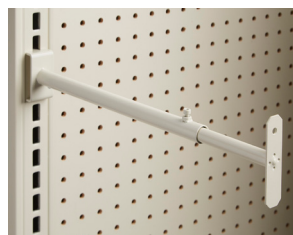

#116990

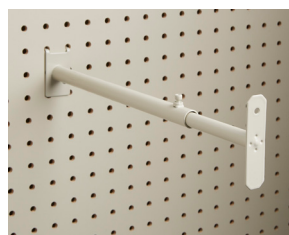
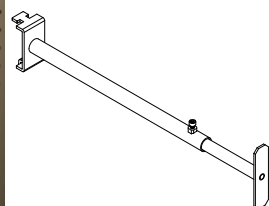

#116920

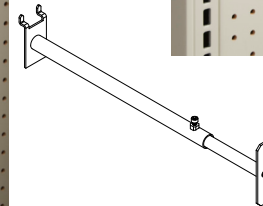

Pegboard Bracket

Fits into most standard pegboard.

- Face plate measures 2-5/8" height x 3/4" wide
- Compatible with Kinter's slide-on grippers and other adhesive sign holders
- ABS material

ITEM #	COLOR
116500	White



Page 111

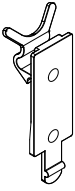

Slatwall Bracket

Fits most standard slatwall.

- Face plate measures 1-5/8" height x 3/4" wide
- Compatible with Kinter's slide-on grippers and other adhesive sign holders
- Polypropylene material



ITEM #	COLOR
116460	Translucent

Page 112

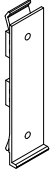

Gondola Upright Bracket

Fits securely into most standard gondola uprights.

- Face plate measures 2-3/4" height x 3/4" wide
- Compatible with Kinter's slide-on grippers and other adhesive sign holders
- ABS material



ITEM #	COLOR
116300	White

Page 112



Warehouse Upright Bracket

Fits securely into most teardrop-shaped holes on standard warehouse uprights (not square or round holes).

- Face plate measures 3" height x 3/4" wide
- Compatible with Kinter's slide-on grippers and other adhesive sign holders
- ABS material



ITEM #	COLOR
116200	White

Page 112



Warehouse Upright Bracket For Square Holes

Fits securely into most square-hole warehouse uprights.

- Face plate measures 3" height x 3/4" wide
- Compatible with Kinter's slide-on grippers and other adhesive sign holders
- ABS material



ITEM #	COLOR
116230	White

Adhesive Wire Grid Sign Holder

Display signs on common wire grid fixtures for increased visibility, using the peel-and-stick foam tape adhesive. Great for use on most standard power wing fixtures. Double clip-on design firmly attaches to wires and prevents rotation.

- Fits 1" wire grid fixtures up to 0.188" diameter
- Peel-and-stick adhesive area is 2" tall
- 1-1/4" wide
- Custom widths available
- Clear PVC material

ITEM #	OVERALL HEIGHT
140896	2-1/8"

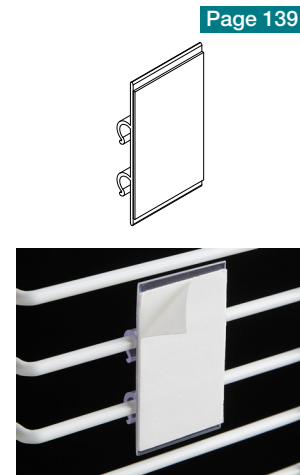

R-Clip With Adhesive

An improved version of our All Purpose Adhesive Clip, now with five gripping "teeth" to help keep signs in place. Sign materials slide in for firm grip. Adheres to any clean, flat surface or can be snapped over wire, using the adhesive side to hold signs, lightweight displays or literature holders.

- 1" wide adhesive back (white foam tape)
- Custom lengths also available
- Clear PVC material

ITEM #	HEIGHT	MAX. GRIP CAPACITY	MAX. WIRE DIAMETER
140857	1"	.200"	.300"



Perpendicular Gripper Sign Holder

Attach signs across open freezer cases or display cases using this perpendicular sign holder with dual grippers, fused together on a high-impact plastic base. Features a heavy-duty bottom gripper and a second gripper on top to hold graphics. Use two units on either side of freezer/display cases to support larger blade signs.

- Bottom gripper has a capacity of .625" to .750"
- Sign gripper has a capacity of .187" to .250"
- Grippers are clear PVC
- Connecting base is clear polycarbonate

ITEM #	HEIGHT	LENGTH	COLOR
106230	2-3/8"	4"	Clear

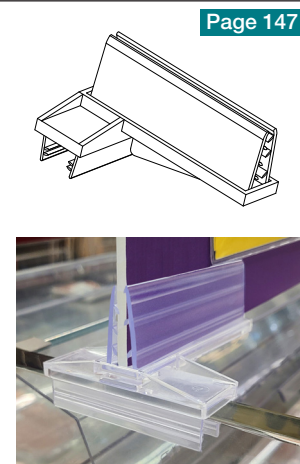

Page 164



Goose Neck Telescopic Sign Holder With Spring Clip

Versatile “goose neck” securely hangs small signs, tags or promotions. Neck pivots using a built-in thumb screw, rotates 360 degrees, and can be raised or lowered. Round base slips under boxes or product, or sits as a standalone. Metal clip has small teeth powered by a metal spring.

- Accepts sign materials up to 0.15" thick
- Clip is zinc plated steel
- Stem and base are black powder coated steel
- Additional finishes or sizes available - please inquire



ITEM #	OVERALL HEIGHT	BASE O.D.	COLOR
150703B	13-1/2" to 20"	4"	Black



Page 165

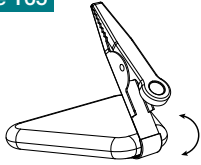

Weighted Base Flat Sign Holder

Compact base with adjustable arm securely holds small signs, tags or promotions. Nicely weighted to keep signs upright. Flexible arm allows metal clip to bend upward to desired angle. Clip has small teeth powered by a metal spring.

- Accepts sign materials up to 0.15" thick
- Clip is zinc plated steel
- Triangular steel base is 1-3/4" wide, vinyl coated
- Features rounded corners for safety



ITEM #	OVERALL LENGTH	COLOR
150707B	3-3/4"	Black

Page 173

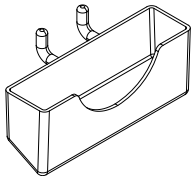

Business Card Holder For Pegboard/Slatwall

Offer business cards or other small objects on common pegboard or slatwall. Handy thumb notch makes “take one” easy. Adds a professional appearance to displays.

- Displays business cards or small objects up to 3-1/2" wide
- Holds up to 50 business cards
- Deluxe .065" thick plastic
- Crystal clear styrene



ITEM #	WIDTH	HEIGHT	DEPTH
150417	3-3/4"	1-1/2"	1"

Page 274

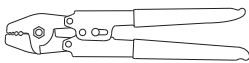

Economy Hand Swager

Our most economical cable tool, yet versatile. Use for hand compression of 1/32", 3/64" and 1/16" aluminum and copper cable sleeves (crimps) and stops. Make three presses (swaged areas) per sleeve. **Warning:** Swaging of fittings over coated cable will result in severely reduced holding power.

- Comfortable, no-slip handle grips
- Locks closed for storage
- High-grade steel, zinc plated



ITEM #	SWAGING CAPACITY	OVERALL LENGTH
105051	1/32," 3/64" or 1/16"	10"



Label Solutions



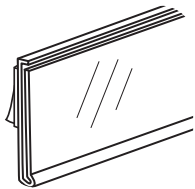

Self-Adhesive Info Strips

Scan codes through the clear facing. Economically hold and protect data tickets, UPC inserts or signs on shelving fronts or any clean, flat surface. Change labels with easy side or top insertion/removal. The 1-1/4" through 2" height sizes can all be cut with scissors to any length.

- Designed to fit common 48" long shelves
- Custom lengths available
- PVC material



	ITEM #	HEIGHT	LENGTH	TYPE OF BACKING TAPE	BACK COLOR
	108625	1-1/4"	47-7/8"	Adhesive Transfer Tape	Clear
NEW	108625B	1-1/4"	47-7/8"	Adhesive Transfer Tape	Black
	108625W	1-1/4"	47-7/8"	Adhesive Transfer Tape	White
	108666	1-1/2"	47-7/8"	Adhesive Transfer Tape	Clear
	108666W	1-1/2"	47-7/8"	Adhesive Transfer Tape	White
	108627	1-3/4"	47-7/8"	Adhesive Transfer Tape	Clear
	108626	2"	47-7/8"	Adhesive Transfer Tape	Clear
NEW	108801	2-1/2"	47-7/8"	Adhesive Transfer Tape	Clear
	108675	3"	47-7/8"	Adhesive Transfer Tape	Clear

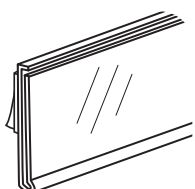

Heavy Duty Self-Adhesive Info Strips

Scan codes through clear facing. Hold and protect data tickets, UPC inserts or signs on shelving fronts or any flat, clean surface. Change labels with easy side or top insertion/removal. The 1-1/4" through 1-1/2" height sizes can be cut with scissors to any length.

- Designed to fit common 48" long shelves
- Custom lengths available
- PVC material
- Custom colors also available



	ITEM #	HEIGHT	LENGTH	TYPE OF BACKING TAPE	BACK COLOR
	108621	1-1/4"	47-7/8"	Foam Tape	White
	108761W	1-3/8"	47-7/8"	Foam Tape	White
	140736W	1-1/2"	47-7/8"	Foam Tape	White
	140736B	1-1/2"	47-7/8"	Foam Tape	Black
	108585W	3-1/2"	47-3/4"	Foam Tape	White

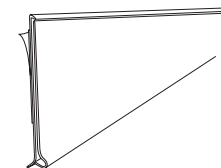

Self-Adhesive Info Strip With Guidebar

Scan codes through clear facing. Unique, integrated bottom guidebar aids with quick, straight installation. Hold and protect data tickets, UPC inserts or signs on shelving fronts or any flat, clean surface. Change labels with easy side or top insertion/removal.

- Designed to fit common shelves
- Custom lengths available
- PVC material



	ITEM #	HEIGHT	LENGTH	TYPE OF BACKING TAPE	BACK COLOR
	108644	1-1/4"	47-5/8"	Adhesive Transfer Tape	White
	140717	1-1/4"	29-5/8"	Adhesive Transfer Tape	White

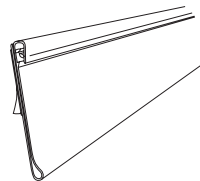

Self-Adhesive Gripper Info Strip

Scan codes through the clear facing. Economically hold and protect data tickets, UPC inserts or signs on shelving fronts or any clean, flat surface. Change labels with easy side or top insertion/removal. As an added bonus, integrated gripper fins along the top edge allow thin signs or advertisements to be held on the outside of the window, thus eliminating the need for additional clips. Can be cut with scissors to any length.

- Designated to fit common 48" long shelves
- Holds up to 1-3/8" height tickets
- Custom lengths, heights, and additional back colors available – please inquire
- PVC material
- Packaged 50 per box



	ITEM #	HEIGHT	LENGTH	TYPE OF BACKING TAPE	BACK COLOR
	108778	1-3/8"	47-7/8"	Adhesive Transfer Tape	Clear

Snap-In Gripper Info Strip

Scan codes through the clear facing window. Economically hold and protect data tickets, UPC inserts or signs directly off of common "C" channel shelving fronts. Change labels with easy side or top insertion/removal while T-top window design helps protect labels from dust or spills. As an added bonus, integrated gripper fins along the top edge allow thin signs or advertisements to be held on the outside of the window, thus eliminating the need for additional clips.

- Designed to fit common 48" long shelves
- Both sizes snap fit into common 1-1/4" height shelf price channels
- Custom lengths and additional back colors available
- PVC material

ITEM #	HEIGHT	LENGTH	TYPE OF BACKING	BACK COLOR
108757W	1-1/4"	47-11/16"	Snap-In	White
108757B	1-1/4"	47-11/16"	Snap-In	Black
108757C	1-1/4"	47-11/16"	Snap-In	Clear
108777C	1-3/8"	47-11/16"	Snap-In	Clear



Snap-In Info Strip

Scan codes through the clear facing window. Economically holds and protects data tickets, UPC inserts or signs directly off common "C" channel shelving fronts. Change labels with easy side or top insertion/removal while T-top window design helps protect labels from spills.

- Designed to fit common 48" long shelves
- Snap fits into common 1-1/4" height shelf price channels
- Custom lengths and additional back colors available
- PVC material

ITEM #	HEIGHT	LENGTH	TYPE OF BACKING	BACK COLOR
108785W	1-1/4"	47-5/8"	Snap-In	White
108785B	1-1/4"	47-5/8"	Snap-In	Black
108785C	1-1/4"	47-5/8"	Snap-In	Clear
108953W	2"	47-5/8"	Snap-In	White



Modified Snap-In Info Strip

A modified version of our regular Snap-In Info Strip, with a slightly different profile and having no "lip" on the clear facing. Hold and protect data tickets, UPC inserts or signs off common "C" channel shelves. Scan codes through the clear facing. Change labels from the side or top.

- Front facing is straight, with no "lip"
- Designed to fit common 48" long shelves
- Snap fits into common 1-1/4" height shelf price channels
- Custom lengths and additional back colors available
- PVC material

ITEM #	HEIGHT	LENGTH	TYPE OF BACKING	BACK COLOR
140633B	1-1/4"	47-5/8"	Snap-In	Black

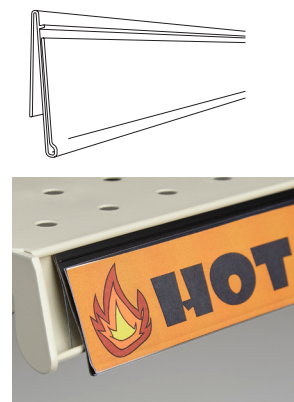

Angled Economy Info Strip Label Holder

Scan codes through the clear facing window. Economically hold and protect data tickets, UPC inserts or signs directly off common "C" channel shelving fronts. Unique reversible angled design allows for the displaying of labels from either below or above the shelf face. Signs can be bottom-inserted for above-shelf applications or top-inserted for below-shelf applications.

- Accepts labels up to 1-1/4" height
- Designed to fit common 48" long shelves
- Snap fits into common 1-1/4" height shelf price channels
- Custom lengths and back colors available – please inquire
- PVC material

ITEM #	HEIGHT	LENGTH	TYPE OF BACKING	BACK COLOR
108800	1-1/4"	47-11/16"	Snap-In	Clear

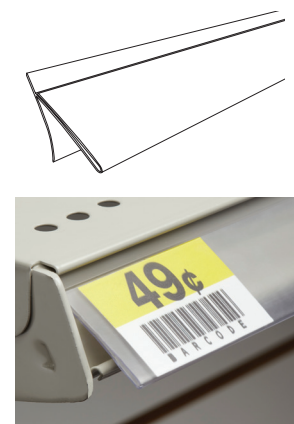

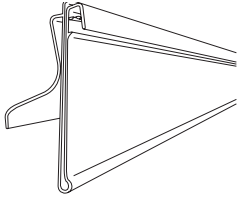

Angled Info Strip With Gripper

Scan codes through the clear facing. Economically hold and protect data tickets, UPC inserts or signs directly off common "C" channel shelving fronts. Change labels with easy side or top insertion/removal. Unique angled design allows for displaying of labels on low or bottom shelves. As an added bonus, integrated gripper fins along the top edge allow thin signs or advertisements to be held on the outside of the window, thus eliminating the need for additional clips.

- Accepts labels up to 1-1/2" height
- Designed to fit common 48" long shelves
- Snap fits into common 1-1/4" height shelf price channels
- Custom lengths and back colors available – please inquire
- PVC material



ITEM #	HEIGHT	LENGTH	TYPE OF BACKING	BACK COLOR
108857	1-1/2"	47-5/8"	Snap-In	Clear

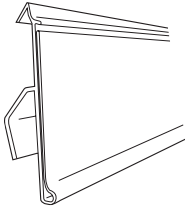

Legged Snap-In Info Strip

Scan codes through the clear facing window. Back leg snaps firmly into channel. Economically holds and protects data tickets, UPC inserts or signs directly off common "C" channel shelving fronts. Change labels with easy side or top insertion/removal.

- Often used in coolers with "C" channels
- Designed to fit common 48" long shelves
- Snap fits into common 1-1/4" height shelf price channels
- Custom lengths and additional back colors available
- PVC material



ITEM #	HEIGHT	LENGTH	TYPE OF BACKING	BACK COLOR
108733W	1-1/4"	47-5/8"	Snap-In	White

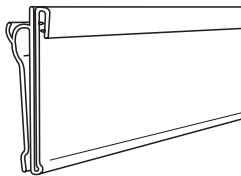

Label Holder For Cooler/Freezer Shelf Channel

Hold and protect data tickets, UPC inserts or signs on common cooler/freezer shelving, as well as common "C" channel shelving fronts. Scan codes through the clear window. Change labels with easy side or top insertion/removal. As an added bonus, gripper fins along the top edge allow secondary signs or advertisements to be held outside the window.

- Snaps into most cooler/freezer shelving
- Also fits common 1-1/4" shelf channels
- Custom lengths and additional back colors available
- PVC material



ITEM #	HEIGHT	LENGTH	TYPE OF BACKING	BACK COLOR
140732B	1-1/4"	30"	Snap-In	Black
140733B	1-1/4"	47-5/8"	Snap-In	Black

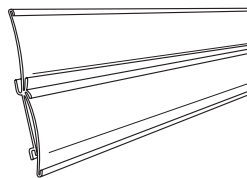

Double Curved "C" Channel For Shelf Channel

Double your marketing impact with a simultaneous way to add pricing or advertisements to most 1-1/4" shelf price channels. Dual (top and bottom) curved open face design easily accepts common data tickets, tags or signs in addition to product or category messages.

- Both top and bottom accept common 1-1/4" height data tickets
- Fits standard 1-1/4" shelf price channels
- Custom lengths and colors available
- Clear PVC material



ITEM #	OVERALL HEIGHT	LENGTH	COLOR
108678	2-1/2"	47-5/8"	Clear

Chip Strip For Price Channel

Economically protect tickets, labels or pricing while maintaining visibility. Fits most standard 1-1/4" metal shelf channels. Die-cut production guarantees consistent size. Available in square-cornered rectangular style or in "T" shape style with a tab for quicker placement/removal.

- For use with either adhesive labels or non-adhesive tags
- Clear PVC material
- #107164 comes on perforated sheets at 32 pieces per sheet
- Label remover tools available (sold separately)
- Packaged as shown below and sold in full packs only

	ITEM #	WIDTH	THICKNESS	PACKAGED	STYLE
	107164	2"	12 mil	512 per box	Rectangular
NEW	107176	1-1/2"	10 mil	500 per bundle	Rectangular
	107170	2-1/2"	10 mil	500 per bundle	Rectangular
	107171	2-1/2"	20 mil	100 per bag	"T" Shape With Tab
	107168	3"	10 mil	504 per box	Rectangular

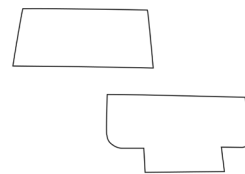

Label Solutions

Mini "Stick-On" Tag

Simple "stick-on" tag attaches to the edge or underside of shelves/tables. Just fold along the score line, remove the tape liner and press into place.

- Accepts adhesive labels up to 1-3/8" high and 2" long
- Custom sizes available – please inquire
- 9 mil thick
- Clear rigid PVC

ITEM #	HEIGHT	LENGTH	COLOR
150367	1-3/8"	2"	Clear

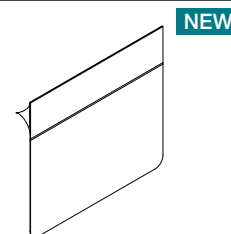

Flip-Up Snap-In Info Strip

Scan codes through the clear facing. Hold and protect data tickets, UPC inserts or signs. Change labels with easy side or top insertion/removal. Integrated hinge allows the strip to flip up for easy access to inventory below and then return to its original position.

- Accepts labels up to 3-1/2" high
- Designed to fit common 48" long shelves
- Snap fits into common 1-1/4" height shelf price channels
- Custom lengths and additional back colors available
- PVC material

ITEM #	HEIGHT	LENGTH	TYPE OF BACKING	BACK COLOR
108735W	3-1/2"	47-3/8"	Snap-In	White

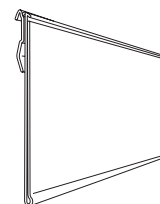

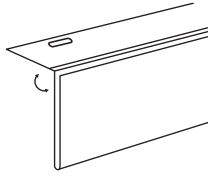

Flip-Up Covered Face Sign Holder

Covered face keeps 1-1/4" through 4" height data tickets, UPC inserts or signs clearly visible and protected. Built-in hinge function flips up to reveal inventory on shelving. Scan codes through the clear facing.

- Fits all standard 48" long perforated shelves with holes
- Dual .250" round and .250" slotted holes for shelf top mounting (mounting fasteners sold separately)
- Custom lengths available
- Also available with adhesive
- Clear PVC material



ITEM #	FACE HEIGHT	LENGTH	SHELF ATTACHMENT STRIP HEIGHT
108807	1-1/4"	47-7/8"	1-1/4"
108559	2"	47-7/8"	1-1/4"
108561	3"	47-7/8"	1-1/2"
108573	3-1/2"	47-7/8"	1-3/4"
108674	4"	47-7/8"	2-1/4"

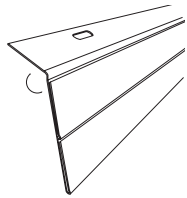

Flip-Up Double-Slot Sign Holder

Two equal size channels, one below the other, each with an open face design that accepts common 1-1/4" data tickets, tags, or signs. Double your marketing impact with a simultaneous way to add pricing or category messages. Built-in hinge function flips up to reveal inventory on shelving. Scan codes through the clear facing.

- Both top and bottom channels accept 1-1/4" height data tickets
- Fits all standard 48" long perforated shelves with holes
- Dual .250" round and .250" slotted holes for shelf top mounting (mounting fasteners sold separately)
- Shelf attachment strip height is 1-1/4" x .030" thick
- Available with adhesive or in custom lengths
- Clear PVC material



ITEM #	FACE HEIGHT	LENGTH
108795	3"	47-7/8"

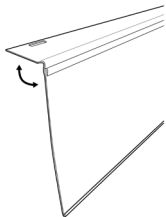

Flip-Up "C" Channel Header

Easily attach product or category information in a header format at the point of sale. Integrated hinge allows the sign to flip up for easy access to inventory below.

- Holds rigid signs up to .040" thick
- Fits all standard perforated shelves with holes
- Shelf attachment strip is 1-3/4" height x .060" thick
- Five .250" slotted holes for shelf top mounting via push-in fasteners (sold separately)
- Also available with adhesive
- Custom lengths and colors available
- Black styrene material



ITEM #	LENGTH	HEIGHT	GRIP CAPACITY
108703	47-3/4"	7"	up to .040"



Flip-Up Pallet Tag

Easily attach pricing or product information to the tag section. Adhesive adheres to the bottom of pallet rack cross members or any other flat, clean surface. Integrated hinge allows the tag to flip up for easy access to inventory below.

- Tag section has radius corners and an integrated hinge
- 1" wide adhesive backed lip
- White removable adhesive
- Clear PVC material



ITEM #	HEIGHT	LENGTH
108546	2-1/8"	7-1/2"

Clip-On Info Strip Label Holder

Scan codes through the clear facing window. Holds signs in horizontal (flush) position. Clips onto the bottom of most "C" channel style shelving fronts without the need for adhesive. Snap-fit design is quick and simple to install. Change labels or messages with easy side or top insertion/removal.

- Accepts signs up to 3-1/2" in height
- Designed to fit common 48" long shelves having a "C" channel front.
- Does not work with flat front shelves
- Also available with other back colors or in different lengths – please inquire
- PVC material

ITEM #	HEIGHT	LENGTH	BACK COLOR
108774W	3-1/2"	47-1/2"	White



Label Solutions

Below Shelf Sign Holder

Covered face keeps up to 3-1/2" height data tickets, UPC inserts or signs clearly visible and protected. Scan codes through the clear facing.

- Top load flush design
- Fits all standard perforated shelves with holes
- Shelf attachment strip is 1-1/2" height x .030" thick
- .250" slotted holes for shelf top mounting with fasteners (sold separately)
- Custom lengths available
- Also available with adhesive
- Clear PVC material

ITEM #	HEIGHT	LENGTH
108592	3"	48"
108681	3-1/2"	5-1/2"
108682	3-1/2"	48"



Shelf-Top Adhesive Info Strips

Hang signs over the edges of shelves or other horizontal surfaces – just peel and stick the foam-tape adhesive. Scan codes through the clear facing. Economically hold and protect data tickets, UPC inserts or signs. Change labels easily.

- Accepts 1-1/4" height signs/tags
- "L" top window helps protect from spills
- Other lengths and back colors available – please inquire
- PVC material

ITEM #	LENGTH	TYPE OF BACKING	BACK COLOR
140984B	47-7/8"	Adhesive Top	Black
140984W	47-7/8"	Adhesive Top	White

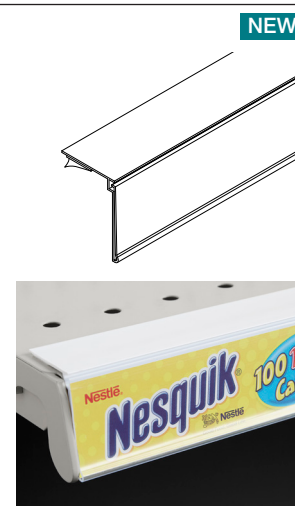

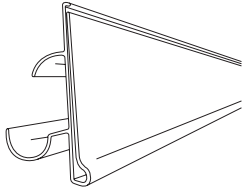

Angled Double Wire Shelf Info Strip

An inexpensive way to add pricing or advertisements to the lower level of most cooler shelves that have parallel front facing cross wires. Simply snap onto the front of 7/8" height freezer/cooler double wire shelves. Scan codes through the clear channel. Hold and protect data tickets, UPC inserts or signs. Change labels with easy side or top insertion/removal.

- Angled design ideal for placement on bottom/lower-level cross wires
- Snaps onto the front of common 7/8" height freezer/cooler double wire shelves
- Holds common 1-1/4" height tags behind the clear facing
- Custom lengths available
- PVC material



ITEM #	HEIGHT	LENGTH	BACK COLOR
140634B	1-1/4"	27-15/16"	Black

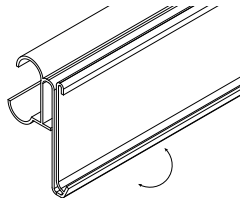

Flip-Up Double Wire Shelf Info Strip With "C" Channel

A simple way to add pricing or advertisements to most cooler shelves that have parallel front facing cross wires. Scan codes through the clear channel. Hold and protect data tickets, UPC inserts or signs. Change labels with easy side or top insertion/removal. Integrated hinge allows the strip to flip up for easy access to inventory below and then return to its original position. As an added bonus, there is an open face "C" channel front that allows for dual-purposing of insert strip advertisements.

- Snaps onto the front of common 7/8" height freezer/cooler double wire shelves
- Holds common 1-1/4" height tags both behind the clear facing or within the "C" channel
- Custom lengths available – please inquire
- PVC material

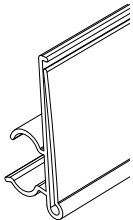

ITEM #	HEIGHT	LENGTH	BACK COLOR
108849B	1-1/4"	22"	Black
108850B	1-1/4"	27-1/2"	Black

NEW

Narrow Double-Wire Shelf Info Strip

Display pricing and promotions on 13/16" height double-wire shelves, sometimes in cooler or freezer cases. Hold and protect data tickets, UPC inserts or signs. Scan codes through the clear facing. Change labels with ease.

- Snaps onto 13/16" height double-wire shelves
- Two label heights to choose from
- Custom lengths and back colors available – please inquire
- PVC material



ITEM #	HEIGHT	LENGTH	BACK COLOR
140933B	1-1/4"	19.5"	Black
140858	1-1/2"	17"	Clear

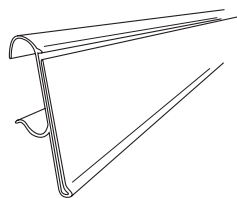

Double Wire Shelf Info Strip

An inexpensive way to add pricing or advertisements to most cooler shelves that have parallel front facing cross wires. Simply snap onto the front of common 7/8" height freezer/cooler double wire shelves. Scan codes through the clear channel. Hold and protect data tickets, UPC inserts or signs. Change labels with easy side or top insertion/removal.

- Snaps onto the front of common 7/8" height freezer/cooler double wire shelves
- Holds common 1-1/4" height tags behind the clear facing
- Custom lengths available
- PVC material



ITEM #	HEIGHT	LENGTH	BACK COLOR
140658	1-1/4"	29-1/2"	Clear
140658W	1-1/4"	29-1/2"	White

Double Wire Shelf “C” Channel

An inexpensive way to add pricing or advertisements to most cooler shelves that have parallel front facing cross wires. Open face design easily accepts common data tickets, tags or signs. Simply snap onto the front of common 7/8" height freezer/cooler double wire shelves.

- Accepts common 1-1/4" height data tickets
- Custom lengths available
- PVC material

ITEM #	HEIGHT	LENGTH	COLOR
108617	1-1/4"	29-1/2"	White
108617B	1-1/4"	29-1/2"	Black

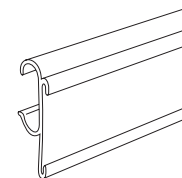

Label Solutions

Info Strip For Cooler/Freezer Shelving

An inexpensive way to hold and protect data tickets, UPC inserts or signs onto the front of non-wire, standard cooler or freezer shelves/rails. Simply snap onto the front for a secure fit. Scan codes through the clear facing and change labels with easy side or top insertion/removal.

- Accepts data tickets up to 1-1/4" height
- Custom lengths available
- PVC material
- Custom back colors available, including clear

ITEM #	HEIGHT	LENGTH	BACK COLOR
108692W	1-1/4"	29-1/2"	White

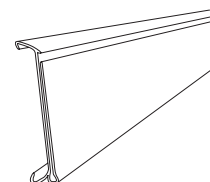

Dual-Purpose Info Strip Label Holder For Slotted Shelf

Scan codes through the clear channel. Hold and protect data tickets, UPC inserts or signs on slotted style, flat facing shelf fronts. Change labels with easy side or top insertion/removal. As an added bonus, integrated open face “C” channel front design allows for dual-purposing of insert strip advertisements.

- Snug fits into common slotted style metal shelf fronts such as Royston
- 35 degree angled clear lens front
- Holds common 1-1/4" height tags both behind the clear facing or within the “C” channel
- Custom lengths and colors also available – please inquire
- PVC material

ITEM #	HEIGHT	LENGTH	TYPE OF BACKING	BACK COLOR
108835B	1-1/4"	35-7/8"	Friction Fit	Black
108884B	1-1/4"	47-7/8"	Friction Fit	Black

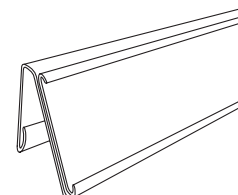

Info Strip Label Holder For Wood Shelving

An inexpensive way to hold and protect data tickets, UPC inserts or signs on fronts of wood shelves or other square edged fixtures. Integrated soft gripper fingers offer a secure fit when snapped onto the front of metal or wood shelves. Scan codes through the clear facing, and change labels with easy side or top insertion/removal.

- Accepts data tickets up to 1-1/4" height
- Fits a range of metal or wood shelves 5/8" through 1-1/8" thick via a 1" long shelf attachment strip
- Custom lengths and colors available
- Clear PVC material

ITEM #	LENGTH	SHELF THICKNESS	COLOR
108816	2"	5/8" thru 3/4"	Clear
108817	48"	5/8" thru 3/4"	Clear
108679	2"	1" thru 1-1/8"	Clear
108680	48"	1" thru 1-1/8"	Clear

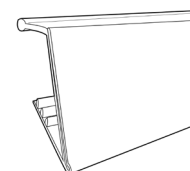

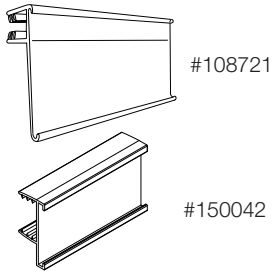

Gripper Display Tracks

Gripper fins clip securely on the front edge of common wood or glass shelves. Open face "C" channel design accepts common 1-1/4" height data tickets, tags or signs.

- Two styles to choose from for different shelf thicknesses
- Custom lengths available – please inquire
- Clear PVC material

ITEM #	FITS SHELF THICKNESS	HEIGHT OF LABEL AREA	LENGTH
108721	1/4"	1-1/4"	2-1/2"
NEW 150042	3/4"	1-1/4"	2-1/2"



NEW

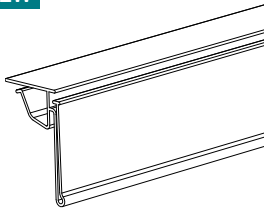

Info Strip For Glass Shelving

Hold and protect data tickets, UPC inserts or signs on common glass shelves. Friction-fit leg attaches quickly and easily. Scan codes through the clear facing. Change labels with side or top insertion/removal while T-top window helps protect labels from spills.

- Fits glass shelves 1/4" to 3/8" thick
- Accepts labels 1-1/4" height
- Custom lengths available – please inquire
- Durable .038" thick clear PVC

ITEM #	HEIGHT	LENGTH	TYPE OF BACKING	BACK COLOR
140960	1-1/4"	47-7/8"	Slide-On	Clear



NEW

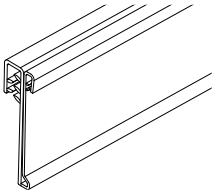

Grip-On Gripper Info Strip

Unique info strip with back-to-back grippers – one on the back to grip shelf fences or corrugated edges, and another on the front to hold small signs or tags. Clear front window holds and protects additional labels and data strips. Change labels with ease.

- Back grip capacity is .040"
- Front grip capacity is .025"
- Other back colors and lengths available – please inquire
- PVC material

ITEM #	HEIGHT	LENGTH	BACKING	BACK COLOR
150019B	1-3/8"	28-7/8"	Gripper	Black
150019W	1-3/8"	28-7/8"	Gripper	White

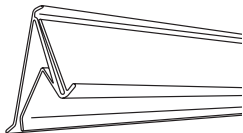

Angled Tag Molding

Display price tags or signs on an angle for improved visibility. Hold and protect data tickets, UPC inserts or signs over wire fencing, product stops or glass shelves. Scan codes through the clear facing. Change labels with easy side or top insertion/removal.

- Angles tags upward or downward for improved visibility
- Clips over horizontal or vertical wire fencing, product stops or glass shelves
- Maximum grip capacity is 3/8"
- Custom lengths and colors available - please inquire
- Heavy-gauge PVC

ITEM #	HEIGHT	LENGTH	TYPE OF BACKING	COLOR
140779B	1-1/4"	24"	Clip-On / Slide-On	Black



“C” Channel Shelf Molding

Otherwise known as Channel Insert Strips. Four different heights to choose from, all of which are designed to attach to shelving fronts or any clean, flat surface. Add pricing or advertisements anywhere with little cost. Open face design easily accepts common data tickets, tags or signs. Simply peel adhesive backed liner and press into place.

- 48" length
- Custom lengths and colors available
- PVC material

ITEM #	HEIGHT	COLOR	TYPE OF BACKING TAPE
108570	1-1/4"	Clear	Foam Tape
108570B	1-1/4"	Black	Foam Tape
108570W	1-1/4"	White	Foam Tape
108570T	1-1/4"	Clear	Adhesive Transfer Tape
108572	2"	Clear	Foam Tape
108572W	2"	White	Foam Tape
108690	3"	Clear	Foam Tape
108690W	3"	White	Foam Tape
108684	4"	Clear	Foam Tape
108684W	4"	White	Foam Tape

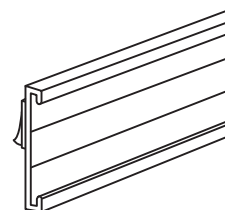

Economy “C” Channel Shelf Molding

A more economical version of our “C” Channel Shelf Molding – with a thinner profile than our standard style – attaching to flat shelving fronts or clean, flat surfaces. Open face design accepts common 1-1/4" tickets, tags or signs. Simply peel adhesive liner and press into place.

- Add pricing/advertisements anywhere with little cost
- 48" length
- Custom lengths and colors available – please inquire
- HIPS material

ITEM #	HEIGHT	COLOR	TYPE OF BACKING TAPE
140940	1-1/4"	White	Transfer Tape
140940B	1-1/4"	Black	Transfer Tape

NEW

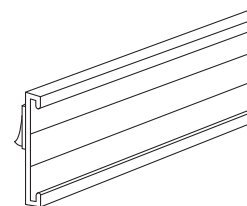

Double “C” Channel With Holes

Arched “C” channel has two levels, allowing multiple messages to be displayed simultaneously. Hangs off standard 48" shelves using shelf fastener #120450 (sold separately).

- Each track accepts 1-1/4" height signs/tags
- Top track is curved backward for improved visibility
- Other lengths and colors available – please inquire
- White styrene material

ITEM #	STYLE	LENGTH	TYPE OF BACKING	COLOR
140900	2-Track	47-7/8"	Hole-Mounted	White

NEW

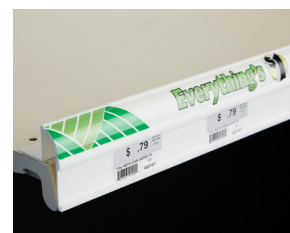
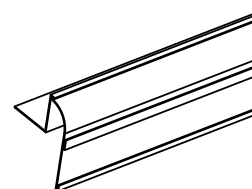

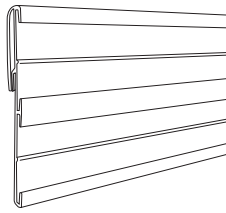

Clip-On Track Sign Channel

Sturdy, two-track channel hangs over plastic fences or thin wire fences, with no adhesive needed. Compatible with multiple front fences offered by Kinter (sold separately).

- Accepts common 1-1/4" height data tickets
- Single-track or additional tracks available
- Custom lengths and colors available
- Black HIPS material

ITEM #	STYLE	LENGTH	OVERALL HEIGHT	COLOR
140752B	2-Track	48"	2-5/8"	Black

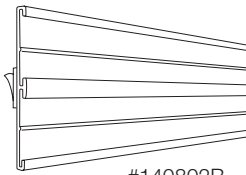

#140802B

Self-Adhesive Track Sign Channel

Channel tracks display 1-1/4" height signs, or taller signs when spread across multiple tracks. Allows unlimited creativity. Adhesive-backed to mount to most clean, flat surfaces.

- Combine promotional and pricing information
- Each track accepts 1-1/4" height signs; taller signs when spread over multiple tracks
- Custom lengths, custom tracks and custom colors available
- Black HIPS material

ITEM #	STYLE	LENGTH	TYPE OF BACKING TAPE	COLOR
140802B	2-Track	48"	Foam Tape	Black
140758B	5-Track	47-7/8"	Foam Tape	Black

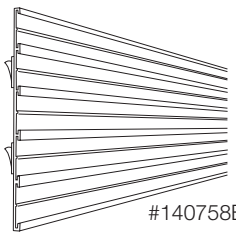

#140758B



#140802B

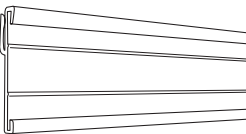

#140801B

Track Sign Channel With Bonus Slot

Channel tracks display 1-1/4" height signs, or taller signs when spread across multiple tracks. Includes a friction-fit slot that runs along the top edge for additional signage to rise above. Allows unlimited creativity.

- Combine promotional and pricing information
- Each track accepts 1-1/4" height signs; taller signs when spread over multiple tracks
- Custom lengths, custom tracks and custom colors available
- Black PVC material

ITEM #	STYLE	LENGTH	TYPE OF BACKING TAPE	COLOR
140801B	1-Track	48"	n/a	Black
140870B	1-Track	48"	Foam Tape	Black
140760B	2-Track	48"	n/a	Black
140803B	3-Track	48"	n/a	Black

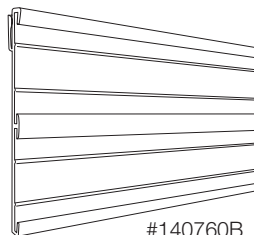

#140760B

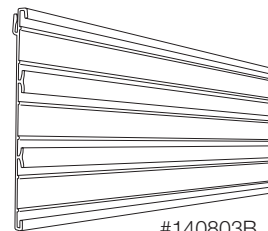

#140803B



Bucket Clip Track Sign Holder

Display signs on floral or produce buckets. Two-track sign holder clips over common buckets or pails and holds signs upward for improved visibility. Channel tracks display 1-1/4" height signs, or 2-1/2" height signs when spread across both tracks. Includes a friction-fit slot that runs along the top edge for additional signage to rise above.

- Combine promotional and pricing information
- Each track accepts 1-1/4" height signs; 2-1/2" height signs when spread over both tracks
- Custom lengths, custom tracks and custom colors available
- Black PVC material

ITEM #	STYLE	LENGTH	OVERALL HEIGHT	COLOR
140749B	2-Track	4"	2-5/8"	Black

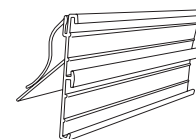

Label Solutions

Spring Clip-On Track Sign Holder

One-track or two-track sign holder is supported by a durable spring clip, allowing attachment to multiple fixtures. Clip is lined with anti-slip coating and securely grips thicker items. Knuckling swivel system allows for display at optimal angles. Friction-fit slots support additional signage (details below).

- Combine promotional and pricing information
- #150319B features one track that accepts 1-1/4" height signs, with a friction-fit slot on top for additional signage to rise above
- #150318B features two tracks that accept 1-1/4" and 2-1/4" height signs, with friction-fit slots on the top and bottom for additional signage to rise above or hang below
- Spring clip has a maximum grip of 1" dia.
- Custom lengths, custom tracks and custom colors available
- Black plastic and black PVC material

ITEM #	STYLE	TRACK HEIGHT	BONUS SLOT	LENGTH	OVERALL HEIGHT	COLOR
150319B	1-Track	1-1/4"	Top	5-1/4"	4-1/4"	Black
150318B	2-Track	1-1/4" and 2-1/4"	Top & Bottom	5-1/2"	6-3/4"	Black

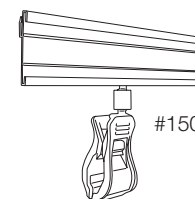

#150319B

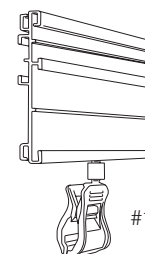

#150318B



Channel Mount Track Sign Holder

Two-track sign holder snaps into common shelf price channels. One track displays 1-1/4" height signs, while the other holds 2-1/4" height signs. Friction-fit slots run along the top and bottom edges for additional signage to rise above or hang below.

- Combine promotional and pricing information
- Accepts 1-1/4" and 2-1/4" height signs
- Custom lengths, custom tracks and custom colors available
- Black PVC material

ITEM #	STYLE	LENGTH	OVERALL HEIGHT	COLOR
140750B	2-Track	5-1/2"	3-5/8"	Black

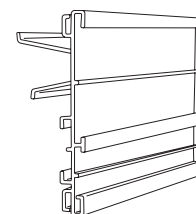

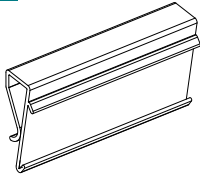
NEW

Clip-On “C” Channel Label Holder

Simple clip-on label holder, attaching to the edges of acrylic bins, wire racks, front fences or corrugated displays. Advertisements or info strips slide into the open “C” channel. Clamps securely but removable and reusable.

- Two channel heights to choose from
- Custom lengths available – please inquire
- Durable plastic material



ITEM #	CHANNEL HEIGHT	LENGTH	MATERIAL	COLOR
140925	1"	3"	PVC	Black
150022	1-1/4"	3"	HIPS	Black

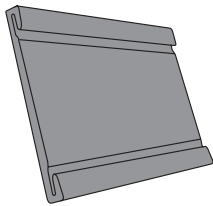

Flexible Magnetic “C” Channel

Open face design, with insert feature, easily accepts common 1-1/4" height data tickets, tags or signs, without leaving adhesive residue behind. Popular flexible magnetic “C” channel that attaches quickly on the fronts of steel shelves or warehouse racks. **Warning:** Magnets should not be used near electronic equipment.

- 1-3/8" overall height x 2" length that accepts common 1-1/4" UPC inserts
- 1/16" thick flexible black magnet with common “C” channel facing
- Custom lengths also available – please inquire

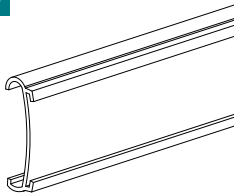

ITEM #	CHANNEL HEIGHT	LENGTH
107073	1-1/4"	2"

NEW

C-Channel for Metro® Shelving

Snaps to the front of Metro® brand wire shelves. Curved, open face design accepts common data tickets, tags or signs.

- Insert common 1-1/4" height signs
- Additional lengths and colors available – please inquire
- Gray or clear PVC material



ITEM #	HEIGHT	LENGTH	COLOR
140962	1-1/4"	3"	Gray
140962C	1-1/4"	3"	Clear
150967C	1-1/4"	44-1/4"	Clear

P.O.P. Sign Holder With Clips

Clear folded design allows for easy sign insertion from the top or side. Perfect for hanging over wire baskets or fencing. Includes four mounting clips (assembled).

- Four clips are spread evenly across the back
- Clips slide independently for perfect positioning
- Clear rigid PVC material
- Sold in full boxes only at 10 complete sets per
- Extra clips #110511 also available if needed – see below

ITEM #	LENGTH	HEIGHT
108838	47-1/2"	4-1/2"

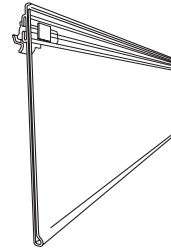

Clip For P.O.P. Sign Holder

Extra clip for our P.O.P. Sign Holder #108838 (sold separately – see above). Provides an adjustable hanging point by sliding along the hanger track. Perfect for hanging over wire baskets or fencing.

- 1" long x 9/16" overall height
- Packaged 25 per bag

ITEM #	COLOR	MATERIAL
110511	Clear	PVC



Extra Duty Info Strip Label Holder For Wire Basket

Scan codes through clear facing. Economically hold and protect data tickets, UPC Inserts or signs on wire baskets or front fences up to 3/8" diameter. Change labels with easy side or top insertion/removal.

- Clips securely over most standard wire fixtures
- Holds up to 1-1/4" height tags or signs
- Custom lengths available
- Clear PVC material

ITEM #	HEIGHT	LENGTH	COLOR
108656	1-1/4"	2"	Clear
108658	1-1/4"	2-1/2"	Clear
108657	1-1/4"	46-1/4"	Clear

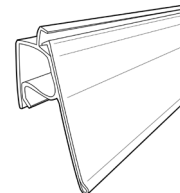

Clear UPC Tag Holder

An economical way to hang 1-1/4" height data tickets, UPC inserts or signs so that they are clearly visible from wire shelves, fixtures or baskets. Each holder includes one of three common hanging options: Plastic Overlap Rings, Spiral Rings or 4" long Cable Ties (Locking Straps). Unique reversible design allows for open-face or covered tag protection, and/or the ability to stick adhesive labels to the back.

- Clear tag holder is 3-1/2" long x 1-3/4" overall height
- White overlap ring is our #101027 (3/4" I.D. x 1" O.D.)
- Clear spiral ring is our #101026C (11/16" I.D. x 13/16" O.D.)
- Natural cable tie is our #130500 (.094" wide x 4" long)
- Custom lengths and colors also available
- Tag holder is clear butyrate material
- Parts come unassembled
- Packaged 100 tag holders and 200 rings/ties per bag

ITEM #	LENGTH	HANGING OPTION INCLUDED
108706	3-1/2"	Plastic Overlap Rings - White
108707	3-1/2"	Plastic Spiral Rings - Clear
108708	3-1/2"	Cable Ties (Locking Straps) - Natural

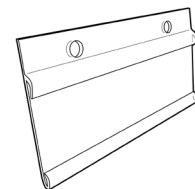

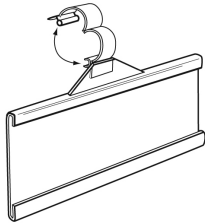

Ticket Holder For Wire Fixtures

Open face design, with insert feature, easily accepts common 1-1/4" height or 1-3/8" height data tickets, tags or signs of varying widths. Attaches quickly and easily to wire baskets, grids and displays. Removable and reusable.

- "C" channel design at top & bottom of face area
- 5/16" wide self attaching hinged clasp/strap
- Fits wire diameters up to .375"
- Polypropylene material
- Also available in black
- Packaged as shown below



ITEM #	HEIGHT OF LABEL AREA	WIDTH OF LABEL AREA	COLOR	PACKAGED
107212	1-1/4"	2"	Natural	250 per bag
107207	1-1/4"	3"	Natural	250 per bag
107214	1-3/8"	4-1/2"	Natural	100 per bag

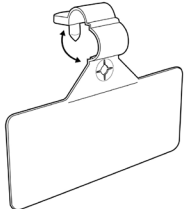

Label Holder For Wire Fixtures

Attaches quickly and easily to wire baskets, grids and displays. Extremely secure and durable. For use with adhesive backed labels. Ideal for displaying pricing or sale information. Removable and repositionable.

- .043" thick
- 1/2" wide self attaching hinged clasp/strap
- Fits wire diameters up to .375"
- Polypropylene material
- Also available in black
- Packaged 250 per bag



ITEM #	HEIGHT OF LABEL AREA	WIDTH OF LABEL AREA	COLOR
107204	1-1/4"	2"	Natural
107205	1-1/4"	3"	Natural
107205W	1-1/4"	3"	White
107206	1-1/4"	3-1/2"	Natural
107206W	1-1/4"	3-1/2"	White

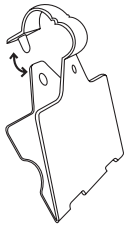

Self-Piercing Covered Ticket Holder

Easily accepts common 1-1/4" height tickets, tags or signs via a simple double-notched, open back, side loading access. Solid clear face window both secures and protects. Ingenious fold-over clasp feature attaches easily to wire baskets, fences, grids and displays.

- Fits wire diameter up to .375"
- 3/8" wide self-attaching hinged clasp/strap
- Polypropylene material
- Packaged 200 per bag



ITEM #	HEIGHT OF LABEL AREA	WIDTH OF LABEL AREA	COLOR
109513	1-1/4"	2"	Natural

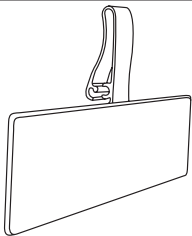

Multi-Purpose Formed Style Label Holder

Ingenious, multi-purpose strap style label holder that attaches to a wide variety of both single and double wire applications, as well as bar merchandisers. Common attachments include wire baskets, grids and cooler shelves that have parallel front facing cross wires or bar merchandisers. Extremely secure and durable. For use with adhesive backed labels. Ideal for displaying pricing or sale information. Removable and repositionable.

- 5/16" wide x 7/8" inside length self-attaching formed style strap
- Fits wire diameters and flat bars up to 9 gauge (.149") thick
- Polypropylene material
- Packaged 250 per bag



ITEM #	HEIGHT OF LABEL AREA	WIDTH OF LABEL AREA	COLOR
107198	1-1/4"	3-1/4"	Natural

Wire Basket Label Holder

A simple and inexpensive way to attach to wire baskets, wire grids and displays. Die-cut production ensures consistent size. For use with adhesive backed labels. Ideal for displaying pricing or sale information.

- Single loop over wire scored design
- Fits wire diameters up to 5/16"
- 5/16" wide self-attaching arrow head slitted feature
- 20 mil thick natural polypropylene material

ITEM #	HEIGHT OF LABEL AREA	WIDTH OF LABEL AREA	COLOR
107215	1"	2"	Natural
107216	1-1/2"	2-1/8"	Natural
107217	1-1/4"	3-3/8"	Natural

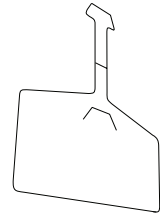

Wire Basket Round Label Holder

A simple and inexpensive way to attach to wire baskets, wire grids and displays. Die-cut production ensures consistent size. For use with round adhesive backed labels. Ideal for displaying pricing or sale information.

- Single loop over wire design
- Fits wire diameters up to 7/16"
- 3/8" wide self-attaching arrow head slitted feature
- 15 mil thick clear PVC material

ITEM #	OVERALL LENGTH	DIAMETER OF LABEL AREA	COLOR
140415	4-7/16"	1-3/4"	Clear



Label Holder For Double Wire Shelf

Attaches quickly and easily to most cooler shelves that have parallel front facing cross wires. Simply clip onto the front of common 7/8" height freezer/cooler double wire shelves. Extremely secure and durable. Ideal for use with adhesive backed pricing labels. Removable and repositionable.

- .050" thick
- 3/8" wide self attaching hinged clasp/strap
- Fits common 7/8" height double wire shelving
- Polypropylene material
- Also available in black
- Packaged 250 per bag

ITEM #	HEIGHT OF LABEL AREA	WIDTH OF LABEL AREA	COLOR
107213	1-1/4"	2-1/4"	Natural



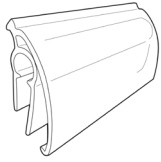

Crystal Ticket Holder

Crystal clear, multi-use ticket holder that securely snaps into common 1-1/4" shelf "C" channels. Can also be used on .188" diameter wire baskets or front fences. Clear cover both protects and holds tickets, UPC inserts or signs firmly while giving them a neat, curved appearance at a desirable viewing angle. Change labels with easy side insertion/removal.

- Holds common 1-1/4" height tickets/labels
- For adhesive labels or non-adhesive tags
- Custom lengths available
- Clear PVC material



	ITEM #	HEIGHT	LENGTH	COLOR
	108829	1-1/4"	2"	Clear
NEW	108033	1-1/4"	2-1/2"	Clear
	108698	1-1/4"	2-7/8"	Clear

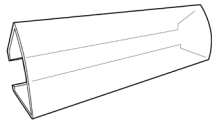

Crystal Wood Shelf Ticket Holder

Hold and protect up to 7/8" height data tickets, tags or signs on the front edge of common wood shelves that are 5/8" through 7/8" thick. "U" shape, friction fit design attaches quickly and easily. When combined with Hook & Loop Fasteners (sold separately – see page 219), can also be used on front edges of tables for skirting.

- 1" height crystal clear front face; holds up to 7/8" height tickets/labels
- 3/4" long top and bottom legs
- Custom lengths available
- Clear PVC material



	ITEM #	HEIGHT OF LABEL AREA	LENGTH	COLOR
	108685	7/8"	2-7/8"	Clear
	108686	7/8"	3-1/8"	Clear

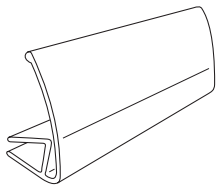

Crystal Glass Shelf Ticket Holder

Hold and protect up to 7/8" height data tickets, tags or signs in a dramatic curved appearance directly on the front edge of common glass shelves that are 3/16" to 1/4" thick. Friction fit leg design that attaches quickly and easily. Change labels with easy side or lower level insertion/removal.

- 1" height crystal clear front face; holds up to 7/8" height tickets/labels
- 3/8" long friction fit top and bottom legs
- Angled front face for optimal viewing
- Custom lengths available
- Clear PVC material



	ITEM #	HEIGHT OF LABEL AREA	LENGTH	COLOR
	108869	7/8"	2-7/8"	Clear

Dual-Purpose Flip-Up Label Holder

Unique label holder with two uses: It attaches to common "C" channel shelving fronts, and also hangs from Kinter's "T-scan" and "scan hook" metal peg hooks (sold separately). Insert and change labels behind the clear window or stick adhesive labels to the front. Flips up for easy access to inventory below and returns to original position.

- Holds labels up to 2" high and 3-1/4" long
- For adhesive or non-adhesive labels
- Custom lengths available – please inquire
- Durable .040" thick material
- Clear PVC

ITEM #	HEIGHT	LENGTH	COLOR
108930	2"	3-1/4"	Clear



NEW

Label Solutions

Flip Info Strip Label Holder For T-Scan Hook

Scan codes through the clear facing, or stick adhesive labels to the front. Clear window provides a clean, neat appearance while protecting data tickets, UPC inserts or signs on "T" style peg hook fronts (otherwise known as T-Scan Hooks). Specially designed to flip up for easy access to inventory below and then return to its original position. Change labels with easy side or top insertion/removal.

- Designed to fit common .120" (11 gauge) to .225" (4 gauge) diameter T-scan hooks
- For adhesive labels or non-adhesive tags
- Custom lengths available
- Clear PVC material

ITEM #	HEIGHT	LENGTH	COLOR
108742	1-1/4"	2"	Clear
108810	1-1/4"	2-1/2"	Clear
108743	1-1/4"	3"	Clear
108803	1-1/4"	3-1/2"	Clear

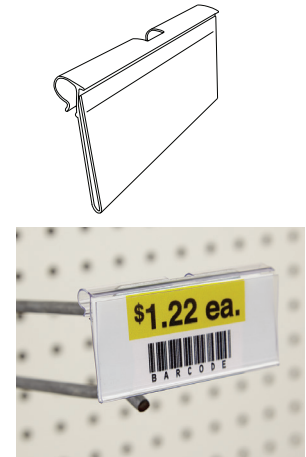

Gripper Flip-Up Info Strip Label Holder For Scan Hooks

An easy and economical way to create a continuous price channel across rows of metal peg hooks. Scan codes through the clear facing or stick adhesive labels to the front. Hold and protect data tickets, UPC inserts or signs on the fronts of common metal peg hooks with bent wire scan arms. Change labels with easy side or top insertion/removal. Integrated hinge allows the strip to flip up for easy access to inventory below and then return to its original position. As an added bonus, gripper fins along the top edge allow thin signs or advertisements to be held on the outside of the window, thus eliminating the need for additional clips.

- For adhesive labels or non-adhesive tags
- Designed to lock onto common .177" through .250" diameter wire hooks
- Custom lengths and back colors also available – please inquire
- Clear PVC material
- Packaged 10 per box

ITEM #	HEIGHT	LENGTH	BACK COLOR
108779	1-3/8"	48"	Clear



Info Strip Label Holder For Multiple Scan Hooks

An easy and economical way to create a continuous price channel across rows of metal peg hooks. Scan codes through the clear facing or stick adhesive labels to the front. Hold and protect data tickets, UPC inserts or signs on the fronts of common metal peg hooks with bent wire scan hook arms. Change labels with easy side or top insertion/removal.

- For adhesive labels or non-adhesive tags
- Designed to lock onto common .177" through .250" diameter wire hooks with scan hook fronts
- Custom lengths and back colors available – please inquire
- Clear PVC material

ITEM #	HEIGHT	LENGTH	BACK COLOR
108845	1-1/4"	47"	Clear

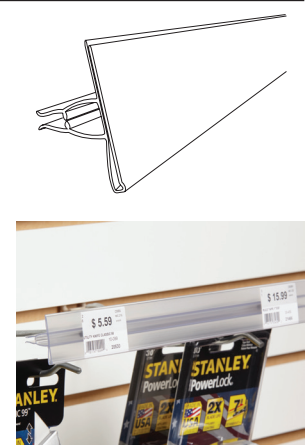

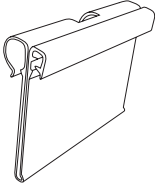

Flip Info Strip Gripper Label Holder For T-Scan Hook

Scan codes through the clear facing, or stick adhesive labels to the front. Clear window provides a clean, neat appearance while protecting data tickets, UPC inserts or signs on "T" style peg hook fronts (otherwise known as T-Scan Hooks). Specially designed to flip up for easy access to inventory below and then return to its original position. As an added bonus, integrated gripper fins along the top edge allow thin signs or advertisements to be held on the outside of the window. Change labels with easy side or top insertion/removal. Also works well on wire fencing or wire baskets.

- Designed to fit common .120" (11 gauge) to .225" (4 gauge) diameter T-scan hooks
- For adhesive labels or non-adhesive tags
- Custom lengths available – please inquire
- Clear PVC material



ITEM #	HEIGHT	LENGTH	COLOR
108786	1-1/4"	2"	Clear



Info Strip Label Holder For Small Scan Plate

Scan codes through the clear facing, or stick adhesive labels to the front. Clear window provides a clean, neat appearance while protecting data tickets, UPC inserts or signs on common .700" height metal peg hook scan plates. Also known as .750" Fishing Tip plates. Change labels with easy side or top insertion/removal.

- Designed for display hooks with .700" height (small) scanning/label holder plates
- For adhesive labels or non-adhesive tags
- Custom lengths available
- Clear PVC material



ITEM #	HEIGHT	LENGTH	COLOR
108696	1-1/4"	2"	Clear



Info Strip Label Holder For Metal Scan Plate

Snaps quickly over common metal scan plates. Also works well on wire baskets or fencing. Scan codes through the clear facing, or stick adhesive labels to the front. Clear window provides a clean, neat appearance while protecting data tickets, UPC inserts or signs on metal plates with 1.250" to 1.380" height. Change labels with easy side or top insertion/removal.

- Designed for display hooks with common 1.250" to 1.380" height scanning/label holder plates
- For adhesive labels or non-adhesive tags
- Custom lengths available
- Clear PVC material

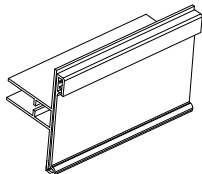

ITEM #	HEIGHT	LENGTH	COLOR
108697	1-1/4"	2"	Clear

NEW

Info Strip Gripper Label Holder For Scan Hook

Snaps onto common 4-gauge scan hooks (sold separately) with a self-centering hole. Clear window provides a clean appearance while protecting data tickets or UPC inserts. Scan codes through the clear facing or stick adhesive labels to the front. As a bonus, gripper fins along the top edge allow thin signs to be held outside the window.

- Designed to fit common 4-gauge hooks (0.212" to 0.225" dia.)
- For adhesive or non-adhesive labels
- Custom lengths available – please inquire
- Clear PVC material



ITEM #	WIRE SIZE	HEIGHT	LENGTH	COLOR
140871	4 Gauge	1-1/4"	2"	Clear

Snap-Shut Label Holder For Scan Hook

Durable label holder for peg hooks with scan hooks. Face snaps open and shut, holding and protecting labels and tags. Scan codes through the clear facing, or stick adhesive labels to the front. Clips onto hook, preventing movement via a self-centering hole. Removable and reusable.

- Makes an audible "click" when face snaps shut properly
- Fits common 4 gauge (.212" to .225" diameter) scan hooks
- For adhesive labels or non-adhesive tags
- Custom lengths available
- Clear PVC material

ITEM #	WIRE SIZE	HEIGHT	LENGTH	COLOR
140737	4 Gauge	1-1/4"	3"	Clear
140681	4 Gauge	1-1/4"	3-1/2"	Clear

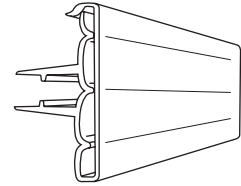

Info Strip Label Holder For Scan Hook

Scan codes through the clear facing, or stick adhesive labels to the front. Clear window provides a clean, neat appearance while protecting data tickets, UPC inserts or signs on peg hook fronts. Change labels with easy side or top insertion/removal. Locks onto hook preventing unwanted label movement via an integrated, self-centering hole.

- Designed to fit common 7 gauge (.177" to .187" diameter) or 4 gauge (.212" to .225" diameter) hooks
- For adhesive labels or non-adhesive tags
- Custom lengths available
- Clear PVC material

ITEM #	WIRE SIZE	HEIGHT	LENGTH	COLOR
108695	7 Gauge	1-1/4"	2"	Clear
NEW 140881	7 Gauge	1-1/4"	2-1/2"	Clear
108784	7 Gauge	1-1/4"	3"	Clear
108736	7 Gauge	1-1/4"	3-1/2"	Clear
108827	4 Gauge	1-1/4"	2"	Clear
108828	4 Gauge	1-1/4"	3"	Clear

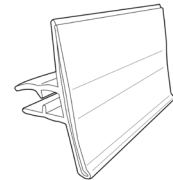

Four-Wire Label Holder For Scan Hooks

Attaches quickly and locks securely on the fronts of all four diameters of our metal peg hooks with bent wire scan hooks (sold separately). Durable construction for long-term use. Ideal for use with adhesive backed pricing labels.

- Smooth front surface having a small label alignment bottom ledge
- Designed to friction-fit common 9 gauge (.149"), 7 gauge (.186"), 4 gauge (.212") and 3 gauge (.250") hooks
- Polypropylene material
- Packaged 100 per bag

ITEM #	HEIGHT	LENGTH	COLOR
109502	1-1/4"	2"	Natural
NEW 109595	1-1/4"	2-5/8"	Natural



Four-Wire Top Insert Label Holder For Scan Hooks

Top loading, clear pocket design that easily accepts and protects common 1-1/4" height data tickets, tags or signs of up to 2" width. Attaches quickly and locks securely on the fronts of all four diameters of our metal peg hooks with bent wire scan hooks (sold separately). Effortlessly change labels with the help of a back-side notched thumb cut-out area. Also stick adhesive labels directly to the smooth front surface. Durable construction for long-term use.

- Designed to friction-fit common 9 gauge (.149"), 7 gauge (.186"), 4 gauge (.212") and 3 gauge (.250") hooks
- For adhesive labels or non-adhesive tags
- Clear plastic
- Packaged 100 per bag

ITEM #	HEIGHT	LENGTH	COLOR
109500	1-1/4"	2"	Clear



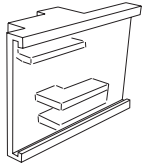

Side Insert Label Holder For Scan Hook

Open face design, with insert feature, easily accepts common 1-1/4" height data tickets, tags or signs of varying lengths. Attaches quickly and locks securely on the fronts of our two most popular diameters of metal peg hooks with bent wire scan arms (sold separately). Change labels with easy side insertion/removal or stick adhesive labels directly to the smooth front surface. Durable construction for long-term use.

- Designed to friction-fit common 7 gauge (.177" to .187" diameter) and 4 gauge (.212" to .225" diameter) hooks
- For adhesive labels or non-adhesive tags
- Clear plastic
- Packaged 25 per bag



ITEM #	HEIGHT	LENGTH	COLOR
107182	1-1/4"	2"	Clear

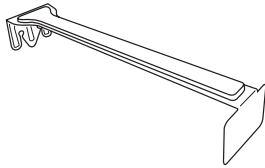

Pegboard Hook Overlays

Convert all-wire hooks to "scan plate" hooks. Display both product and pricing information via an integrated flat front label area that accepts traditional UPC informational style adhesive labels. Designed to fit on top of (overlay) most single prong 1" on center all-wire pegboard hooks in both pegboard and slatwall. Unique flip feature allows for simplified access to product. Easy to install – simply press fit directly into the welded back hook prongs of common metal peg hooks. Single Prong All-Wire Pegboard Hooks (sold separately – see page 51).



Shown with Single Prong All-Wire Pegboard Hook (see page 51)

- Clips over the back and extends the length of hooks for a perfect-fit attachment
- Label area holds adhesive backed labels up to 1-1/4" height x 2-1/8" wide
- Other lengths and label area sizes available – please inquire
- 15 mil thick, clear rigid PVC material
- Packaged 10 pieces per bundle

ITEM #	FITS PEGBOARD HOOKS	STYLE
109547	4" to 5" Long	For Adhesive Labels
109548	6" to 7" Long	For Adhesive Labels
109549	8" to 9" Long	For Adhesive Labels
109550	10" to 11" Long	For Adhesive Labels

NEW

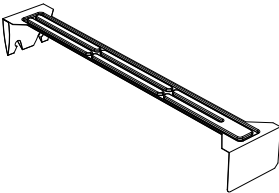

Heavy-Duty Pegboard Hook Overlay

A heavy-duty version of our Pegboard Hook Overlays, converting single-prong hooks into "scan plate" hooks. This heavy-duty style fits our 10" Single Prong All-Wire Pegboard Hooks and our Single Prong Plastic Back Metal Pegboard Hooks (sold separately). Fold the back into a triangular wedge using the tape strip and insert over the hook prongs. Display adhesive labels on the front.

- Fits onto and extends the length of 10" hooks
- Front area holds adhesive labels up to 1-3/8" height x 2-1/8" wide
- Ships flat with minor assembly required
- Other lengths and label sizes available – please inquire
- 13 mil thick, clear rigid PVC material
- Packaged 25 pieces per bag



ITEM #	FITS SINGLE PRONG PEGBOARD HOOKS	STYLE
109650	10" Long	For Adhesive Labels



Display Hooks



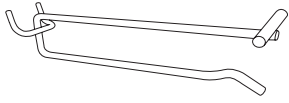

All-Wire Pegboard Hook With T-Scan Bar

Sturdy one-piece metal hook used in common 1 inch on center pegboard or standard slatwall that displays both product and pricing information. Back hook is welded in place for stability. T-scan bar in front accepts our Flip Info Strip Label Holders that flip up and out of the way for product access (sold separately – see page 45). Simple all-wire hook design that installs easily.

- Use with a variety of package hole styles
- Label holders clip on securely and stay centered
- Bottom hook is “downturn” style for added safety
- Peg Hook Product Stops available (see page 61)
- Zinc/galvanized material
- Other sizes and finishes available – please inquire

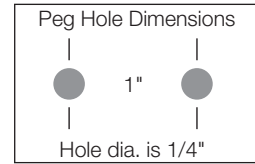

ITEM #	WIRE GAUGE	STEM LENGTH
161174	.186" dia. (7 ga.)	4"
161176	.186" dia. (7 ga.)	6"
161178	.186" dia. (7 ga.)	8"
161170	.186" dia. (7 ga.)	10"
109509	.186" dia. (7 ga.)	11"
161148	.212" dia. (4 ga.)	8"
161140	.212" dia. (4 ga.)	10"
161142	.212" dia. (4 ga.)	12"

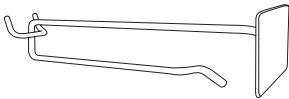

All-Wire Pegboard Hook With Scan Plate

Sturdy one-piece metal hook used in common 1 inch on center pegboard or standard slatwall that displays both product and pricing information. Back hook is welded in place for stability. Scan plate in front accepts traditional adhesive labels or our Info Strip Label Holders For Metal Scan Plate (sold separately – see page 46). Simple all-wire hook design that installs easily.

- Use with a variety of package hole styles
- Scan plate front is 1-3/8" high x 2-1/8" wide with radiused corners for safety
- Bottom hook is “downturn” style for added safety
- Peg Hook Product Stops available (see page 61)
- Zinc/galvanized material
- Other sizes and finishes available – please inquire

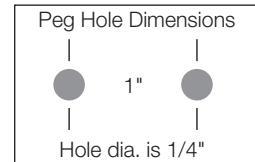

ITEM #	WIRE GAUGE	STEM LENGTH
160774	.186" dia. (7 ga.)	4"
160776	.186" dia. (7 ga.)	6"
160778	.186" dia. (7 ga.)	8"
160744	.212" dia. (4 ga.)	4"
160746	.212" dia. (4 ga.)	6"
160748	.212" dia. (4 ga.)	8"
160740	.212" dia. (4 ga.)	10"
160742	.212" dia. (4 ga.)	12"

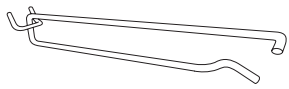

All-Wire Pegboard Hook With Scan Hook

Sturdy one-piece metal hook used in common 1 inch on center pegboard or standard slatwall that displays both product and pricing information. Back hook is welded in place for stability. Right angle scan hook in front accepts our Info Strip Label Holders For Scan Hooks (sold separately – see page 47). Simple all-wire hook design that installs easily.

- Use with a variety of package hole styles
- Bottom hook is “downturn” style for added safety
- Peg Hook Product Stops available (see page 61)
- Zinc/galvanized material
- Other sizes and finishes available – please inquire

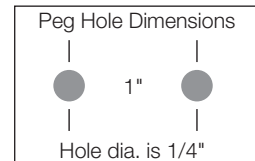

ITEM #	WIRE GAUGE	STEM LENGTH
160674	.186" dia. (7 ga.)	4"
160676	.186" dia. (7 ga.)	6"
160678	.186" dia. (7 ga.)	8"
160646	.212" dia. (4 ga.)	6"
160648	.212" dia. (4 ga.)	8"
160640	.212" dia. (4 ga.)	10"
160642	.212" dia. (4 ga.)	12"

Single Prong All-Wire Pegboard Hook

Sturdy one-piece metal hook used in common 1 inch on center pegboard or standard slatwall. Back hook is welded in place for stability. Our simplest all-wire hook design that installs easily.

- Use with a variety of package hole styles
- Upright style end with ball tip for added safety
- Peg Hook Product Stops available (see page 61)
- Zinc/galvanized material
- Other sizes and finishes available – please inquire

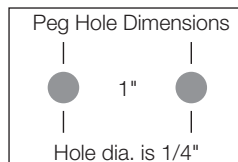

ITEM #	WIRE GAUGE	STEM LENGTH
109508	.149" dia. (9 ga.)	2"
160594	.149" dia. (9 ga.)	4"
160596	.149" dia. (9 ga.)	6"
160598	.149" dia. (9 ga.)	8"
160574	.186" dia. (7 ga.)	4"
160576	.186" dia. (7 ga.)	6"
160578	.186" dia. (7 ga.)	8"
160570	.186" dia. (7 ga.)	10"
160572	.186" dia. (7 ga.)	12"
160544	.212" dia. (4 ga.)	4"
160546	.212" dia. (4 ga.)	6"
160548	.212" dia. (4 ga.)	8"
160540	.212" dia. (4 ga.)	10"
160542	.212" dia. (4 ga.)	12"



Display Hooks

Speedy-Back Metal Peg Hook With Scan Hook

Extremely popular metal peg hook that comes complete with our reinforced Speedy-Back Plastic Adapter. For use in common 1 inch on center pegboard or standard slatwall that displays both product and pricing information. Simply hang the Speedy-Back Adapter in place and then attach the metal hook from a straight entryway – thus no need to disrupt nearby merchandise. Straight entryway with adapter makes for convenient installation, removal and relocation under shelves or on loaded displays. Right angle scan hook in front accepts our Info Strip Label Holders For Scan Hooks (sold separately – see page 47).

- Speedy-Back Adapters are compatible with other manufacturers' metal hooks
- Labor-saving two-piece design
- Use with a variety of package hole styles
- Bottom hook is "downturn" style for added safety
- Additional Speedy-Back Adapters available (see page 52)
- Peg Hook Product Stops available (see page 61)
- Speedy-Back Adapters are made of strong, glass filled nylon
- Hooks are zinc plated steel material
- Other sizes and finishes available – please inquire
- Packaged 25 metal hooks and 25 plastic adapters per bag, unassembled

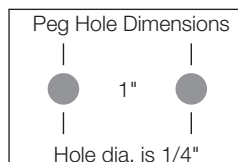

ITEM #	WIRE GAUGE	SPEEDY-BACK COLOR	STEM LENGTH
160874	.186" dia. (7 ga.)	Beige	4"
160876	.186" dia. (7 ga.)	Beige	6"
160878	.186" dia. (7 ga.)	Beige	8"
160844	.212" dia. (4 ga.)	Gray	4"
160846	.212" dia. (4 ga.)	Gray	6"
160848	.212" dia. (4 ga.)	Gray	8"
160840	.212" dia. (4 ga.)	Gray	10"
160842	.212" dia. (4 ga.)	Gray	12"

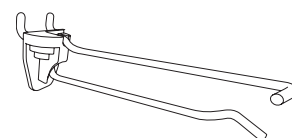

Speedy-Back Metal Peg Hook With T-Scan Bar

Extremely popular metal peg hook that comes complete with our reinforced Speedy-Back Plastic Adapter. For use in common 1 inch on center pegboard or standard slatwall that displays both product and pricing information. Simply hang the Speedy-Back Plastic Adapter in place and then attach the metal hook from a straight entryway – thus no need to disrupt nearby merchandise. Straight entryway with adapter makes for convenient installation, removal and relocation under shelves or on loaded displays. T-scan bar in front accepts our Flip Info Strip Label Holders that flip up and out of the way for product access (sold separately – see page 45).

- Speedy-Back Adapters are compatible with other manufacturers' metal hooks
- Labor-saving two-piece design
- Use with a variety of package hole styles
- Label holders clip on securely and stay centered
- Bottom hook is "downturn" style for added safety
- Additional Speedy-Back Adapters available (see page 52 below)
- Peg Hook Product Stops available (see page 61)
- Speedy-Back Adapters are made of strong, glass filled nylon
- Hooks are zinc-plated steel material
- Other sizes and finishes available – please inquire
- Packaged 25 metal hooks and 25 plastic adapters per bag, unassembled

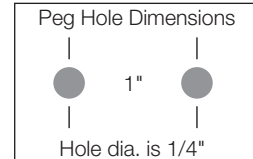

ITEM #	WIRE GAUGE	SPEEDY-BACK COLOR	STEM LENGTH
161074	.186" dia. (7 ga.)	Beige	4"
161076	.186" dia. (7 ga.)	Beige	6"
161078	.186" dia. (7 ga.)	Beige	8"
161044	.212" dia. (4 ga.)	Gray	4"
161046	.212" dia. (4 ga.)	Gray	6"
161048	.212" dia. (4 ga.)	Gray	8"
161040	.212" dia. (4 ga.)	Gray	10"
161042	.212" dia. (4 ga.)	Gray	12"

Display Hooks

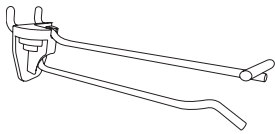

Speedy-Back Adapter For Straight Entry Metal Hook

Insert or move metal peg hooks without disrupting nearby merchandise with this simple, sturdy plastic adapter. Flush mount back plate connector that is used to place and support metal peg hooks into 1 inch on center pegboard or standard slatwall. Makes for convenient installation, removal and relocation under shelves or loaded displays. Also compatible with .212" diameter aisle sign arm hangers (see page 150). Removable and reusable.

- Easy to install and works with common .186" and .212" wire diameter straight entry metal peg hooks
- Completely compatible with other manufacturers' metal hooks and planograms
- Color coded to front wire diameter for ease of use
- Two prongs 1" on center and having 5/8" height
- 1-5/8" length x 1-5/16" wide and ribbed for added support
- Glass filled nylon material
- Packaged 100 per bag

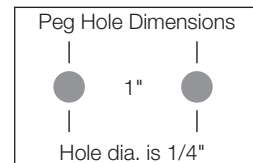

ITEM #	WIRE GAUGE	TYPE	COLOR
107737	.186" dia. (7 ga.)	Medium-Duty	Beige
107734	.212" dia. (4 ga.)	Heavy-Duty	Gray

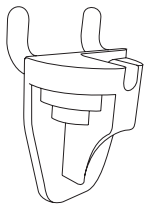

Single Prong Plastic Back Metal Pegboard Hook

Our simplest plastic back metal hook design that saves on labor and, once assembled, does not have to be taken apart. Extremely popular metal single prong peg hook that comes complete with our sturdy Pegboard/Slatwall Plastic Back Adapter. For use in common 1" on center pegboard or standard slatwall. Simply hang the Pegboard/Slatwall Plastic Back Adapter in place and then attach the metal hook from a straight entryway – thus, no need to disrupt nearby merchandise. Straight entryway with adapter makes for convenient installation, removal and relocation under shelves or on loaded displays.

- Use with a variety of package hole styles
- Upturn style end with ball tip for added safety
- Additional Pegboard/Slatwall Plastic Back Adapters available (see below)
- Peg Hook Product Stops available (see page 61)
- Pegboard/Slatwall Plastic Back Adapters are made of white delrin material
- Hooks are zinc plated steel material
- Other sizes and finishes are available – please inquire
- Packaged 25 metal hooks and 25 plastic adapters per bag – unassembled

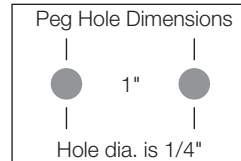

ITEM #	WIRE GAUGE	STEM LENGTH
161274	.186" dia. (7 ga.)	4"
161276	.186" dia. (7 ga.)	6"
161278	.186" dia. (7 ga.)	8"
161270	.186" dia. (7 ga.)	10"
161272	.186" dia. (7 ga.)	12"
161244	.212" dia. (4 ga.)	4"
161246	.212" dia. (4 ga.)	6"
161248	.212" dia. (4 ga.)	8"
161240	.212" dia. (4 ga.)	10"
161242	.212" dia. (4 ga.)	12"



Display Hooks

Pegboard/Slatwall Plastic Back Adapter

Flush mount back plate connector that can be used to place and support Single Prong Metal Peg Hooks into 1 inch on center pegboard or standard slatwall. Insert or move metal peg hooks without disturbing nearby merchandise with this simple, sturdy plastic adapter. Makes for convenient installation, removal and relocation under shelves or loaded displays. Removable and reusable.

- Easy to install and works with common .177" - .187" (7 gauge) and .212" - .225" (4 gauge) wire diameters
- Fits standard 1/4" diameter pegboard holes and all standard slatwall grooves
- Tapered style backplate is 1-5/16" wide x 1-3/16" height
- Two prongs at 1" on center and having 5/8" height
- White delrin material
- Available in additional colors and diameter receptacles – please inquire
- Packaged 100 per bag

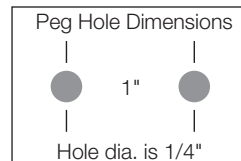

ITEM #	WIRE GAUGE	TYPE	COLOR
107704	.186" dia. (7 ga.)	Medium-Duty	White
107701	.212" dia. (4 ga.)	Heavy-Duty	White



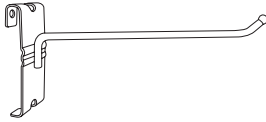

Single Prong Metal Grid Hook

Sturdy metal hook with welded backplate that hangs on both 2" and 3" metal grids. Top notched back plate fits over center grid cross wires for flexibility during placement. Installs easily and offers great stability.

- Use with a variety of package hole styles
- Upturn style end with ball tip for added safety
- Notched back plate is 3-3/8" height x 1-3/16" wide
- Peg Hook Product Stops available (see page 61)
- Zinc plated steel material
- Other sizes and finishes available – please inquire
- Packaged 25 per bag



ITEM #	WIRE GAUGE	STEM LENGTH
160244	.212" dia. (4 ga.)	4"
160246	.212" dia. (4 ga.)	6"
160248	.212" dia. (4 ga.)	8"

NEW

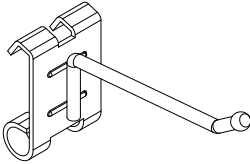

Curl Back Crossbar Hook

Sturdy metal hook with welded backplate hangs on 3/16" x 1" crossbars or 1" wire grids. Great for endcap merchandisers, including Kinter's Wire Power Wings #181518 (sold separately). Installs easily with firm stability.

- Curl back design provides friction fit
- Upturn style end with ball tip for safety
- Zinc plated steel material
- Other sizes and finishes available – please inquire



ITEM #	WIRE GAUGE	STEM LENGTH
161402	.149" dia. (9 ga.)	2"

NEW

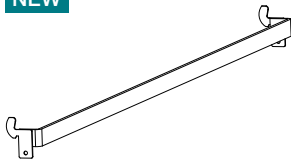

Universal Crossbar

- Use to create 3-dimensional, tiered displays
- Installs into most standard gondola uprights
- Compatible with various crossbar hooks and accessories
- Custom depths available – please inquire



ITEM #	DIMENSIONS	FINISH
180200	1-3/8" Deep x 1" Height x 48" Long	Chrome

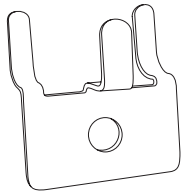

Pin-Up Hook

Designed to securely hang displays such as wire baskets directly to pegboard and slatwall. Economical solution for hanging single items such as picture frames, clocks or crafts. Otherwise known as "pin-up hooks" or "clock hooks." Integrated center hole allows for additional mounting options. Removable and reusable.

- Back prongs are 1" on center
- Fits both standard 1/4" diameter pegboard and common slatwall
- Center hole is 1/4" diameter
- "J" style hook extends 3/8" outward and 3/8" upward
- .060" thick zinc plated steel
- Packaged 100 per bag

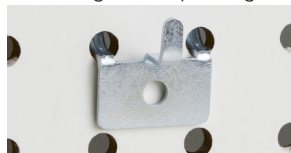
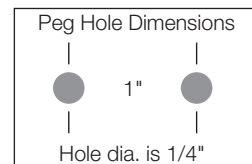

ITEM #	HEIGHT	LENGTH
109511	1-1/8"	1-1/4"

Corrugated Tapered Back Display Hooks

Our most popular display hook for corrugated use. Labor saving, one piece design that is very stable and installs easily. Strong plastic material adds strength so hooks resist sagging. Works with a large variety of product hole styles.

- .141" wide x .219" height stem
- 3/4" wide x 1" height face plate with integrated raised/tapered back insertion leg design
- Fits 1/8" (B-Flute) corrugated having "T" slots for insertion
- Other lengths available
- Glass filled nylon material

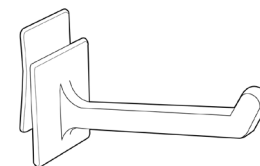
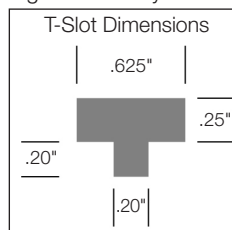

ITEM #	STEM LENGTH	COLOR
107301	1"	White
107301B	1"	Black
107302	2"	White
107302B	2"	Black
107303	3"	White
107303B	3"	Black
107304	4"	White
107304B	4"	Black
107305	5"	White
107305B	5"	Black
107306	6"	White
107306B	6"	Black
107307	7"	White
107307B	7"	Black
107308	8"	White
107308B	8"	Black

Display Hooks

Tapered Display Hooks With Scan Plate

A very popular corrugated display hook having a flat front scan plate/tag section that allows for attachment of adhesive backed UPC labels, pricing or product information above merchandise. Tapered back design is very stable and installs easily. Strong plastic material adds strength so hooks resist sagging. Works with a large variety of product hole styles.

- Flat scan plate front is 1-3/8" height x 2-1/8" wide
- .141" wide x .219" height stem
- 3/4" wide x 1-3/4" height face plate with integrated raised/tapered back insertion leg design
- Fits 1/8" (B-Flute) corrugated having "T" slots for insertion
- Other lengths or colors available – please inquire
- White glass filled nylon material

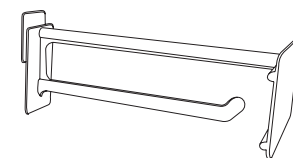
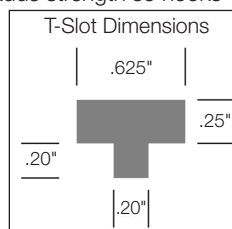

ITEM #	STEM LENGTH
107232	2"
107233	3"
107234	4"
107236	6"

Tapered Display Hooks With "C" Channel

A very popular corrugated display hook having an open face "C" channel design that accepts common data tickets, tags or signs having 1-1/4" height. Add pricing or advertisements above merchandise with little cost. Tapered back design is very stable and installs easily. Strong plastic material adds strength so hooks resist sagging. Works with a large variety of product hole styles.

- "C" channel size is 1-1/4" height x 3" width
- .141" wide x .219" height stem
- 3/4" wide x 1-3/4" height face plate with integrated raised/tapered back insertion leg design
- Fits 1/8" (B-Flute) corrugated having "T" slots for insertion
- Other lengths or colors available – please inquire
- White glass filled nylon material

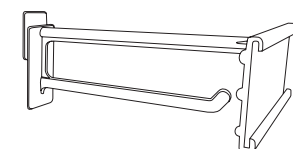
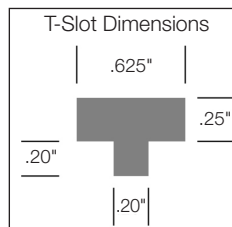

ITEM #	STEM LENGTH
107432	2"
107434	4"
107436	6"

Tapered Display Hooks With T-Scan Bar

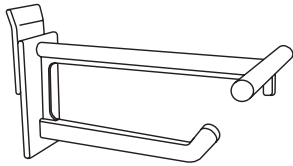

A popular corrugated display hook having a "T" style front, allowing the attachment of flip-up label holders (sold separately). Add pricing or advertisements above merchandise with little cost. Tapered back design is stable and installs easily. Strong plastic material adds strength so hooks resist sagging. Works with a variety of product hole styles.

- T-scan front is .187" diameter x 1-1/2" wide
- .141" wide x .219" height stem
- Fits 1/8" (B-Flute) corrugated having "T" slots for insertion
- Other lengths or colors available - please inquire
- White glass filled nylon material

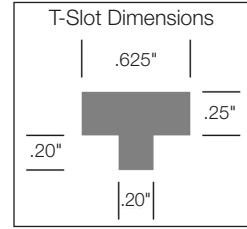

ITEM #	STEM LENGTH
107242	2"
107244	4"
107246	6"

Butterfly Display Hooks

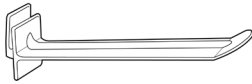

Unique butterfly shaped one piece design that is easy to install and holds packages having delta or butterfly holes. Strong plastic material adds strength so hooks resist sagging.

- .740" wide x .250" height stem
- 3/4" wide x 1" height face plate with integrated raised back insertion leg design
- Fits 1/8" (B-Flute) corrugated having oval slots for insertion
- Other lengths available
- Glass filled nylon material

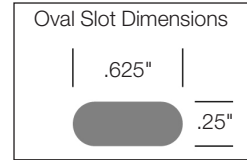

ITEM #	STEM LENGTH	COLOR
107321	1"	White
107322	2"	White
107322B	2"	Black
107323	3"	White
107323B	3"	Black
107324	4"	White
107324B	4"	Black
107325	5"	White
107325B	5"	Black
107326	6"	White
107326B	6"	Black
107327	7"	White
107327B	7"	Black

Corrugated Universal Butterfly Display Hooks

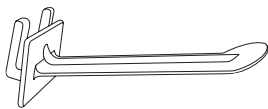

Unique butterfly shaped design that is simple to insert and holds packages having delta or butterfly holes. One piece, double back prong design that is both strong and extremely stable. Unlike other round two prong designs that require pre-punched holes or T-slots for insertion, our line of universal hooks work with simple X-cuts (X-slits). Strong plastic material also adds strength so hooks resist sagging.

- .740" wide x .250" height stem
- 1-1/4" wide x 1" height face plate with two upward facing prongs
- Fits 1/8" (B-Flute) corrugated having 1" on center X-cuts for insertion
- Not for use with pegboard or slatwall
- Other lengths or colors available - please inquire
- White glass filled nylon material

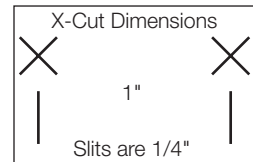

ITEM #	STEM LENGTH
107293	3"
107294	4"
107295	5"
107296	6"
107298	8"

Corrugated Universal Display Hooks With “C” Channel

Popular corrugated display hook that is simple to insert while having an open face “C” channel design that accepts common data tickets, tags or signs having 1-1/4" height. Add pricing or advertisements above merchandise with little cost. Double prong back design is both strong and extremely stable. Unlike other round two prong designs that require pre-punched holes or T-slots for insertion, our line of universal hooks work with simple X-cuts (X-slits). Strong plastic material also adds strength so hooks resist sagging. Works with a large variety of product hole styles.

- “C” channel size is 1-1/4" height x 3" width
- .141" wide x .219" height stem
- 1-1/4" wide x 1-3/4" height V-shaped face plate with two upward facing prongs
- Fits 1/8" (B-Flute) corrugated having 1" on center X-cuts for insertion
- Not for use with pegboard or slatwall
- Other lengths or colors available – please inquire
- White glass filled nylon material

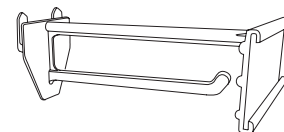
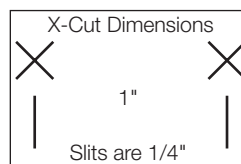

ITEM #	STEM LENGTH
107384	4"
107386	6"

Display Hooks

Corrugated Universal Display Hooks With Scan Plate

Popular corrugated display hook that is simple to insert while having a flat front scan plate/tag section that allows for attachment of adhesive backed UPC labels, pricing or product information above merchandise. Double prong back design that is strong and extremely stable. Unlike other round two prong designs that require pre-punched holes or T-slots for insertion, our line of universal hooks work with simple X-cuts (X-slits). Strong plastic material also adds strength so hooks resist sagging. Works with a large variety of product hole styles.

- Flat scan plate front is 1-3/8" height x 2-1/8" wide
- .141" wide x .219" height stem
- 1-1/4" wide x 1-3/4" height V-shaped face plate with two upward facing prongs
- Fits 1/8" (B-Flute) corrugated having 1" on center X-cuts for insertion
- Not for use with pegboard or slatwall
- Other lengths or colors available – please inquire
- White glass filled nylon material

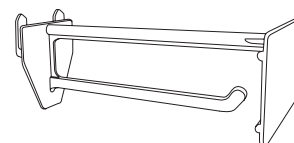
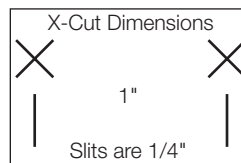

ITEM #	STEM LENGTH
107392	2"
107394	4"
107396	6"

Corrugated Universal Display Hooks With T-Scan Bar

Popular corrugated display hook that is simple to insert while having a “T” style scan bar peg hook front that allows for attachment of flip info strip label holders that are sold separately (see page 45). Double prong back design that is both strong and extremely stable. Unlike other round two prong designs that require pre-punched holes or T-slots for insertion, our line of universal hooks work with simple X-cuts (X-slits). Strong plastic material adds strength so hooks resist sagging. Works with a large variety of product hole styles.

- T-scan peg hook bar front is .187" diameter x 1-1/2" wide
- .141" wide x .219" height stem
- 1-1/4" wide x 1-3/4" height V-shaped face plate with two upward facing prongs
- Fits B-Flute (1/8") corrugated having 1" on center X-cuts for insertion
- Not for use with pegboard or slatwall
- Other lengths or colors available – please inquire
- White glass filled nylon material

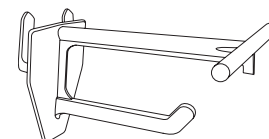
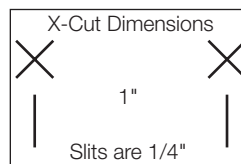

ITEM #	STEM LENGTH
107422	2"
107424	4"
107426	6"

Corrugated Universal Display Hooks

A very popular corrugated display hook that is both economical and simple to insert. One piece, double back prong design that is strong and extremely stable. Unlike other round two prong designs that require pre-punched holes or T-slots for insertion, our line of universal hooks work with simple X-cuts (X-slits). Strong plastic material also adds strength so hooks resist sagging. Works with a large variety of product hole styles and has ridges to keep merchandise up front.

- .141" wide x .219" height stem with integrated ridges
- 1-1/4" wide x 1" height face plate with two upward facing prongs
- Fits 1/8" (B-Flute) corrugated having 1" on center X-cuts for insertion
- Not for use with pegboard or slatwall
- Other lengths or colors available – please inquire
- White glass filled nylon material

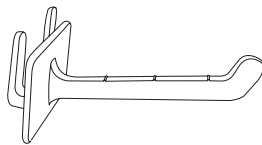
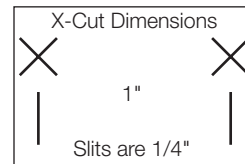

ITEM #	STEM LENGTH
107371	1-1/4"
107372	2"
107374	4"
107376	6"
107378	8"

Corrugated/Wire Combo Display Hooks With "C" Channel

Popular corrugated display hook having an open face "C" channel design that accepts common data tickets, tags or signs having 1-1/4" height. Add pricing or advertisements above merchandise with little cost. Unique over the top back design allows for use on both corrugated and wire displays. Strong plastic material adds strength so hooks resist sagging. Works with a large variety of product hole styles.

- "C" channel size is 1-1/4" height x 3" width
- .141" wide x .219" height stem
- 3/4" wide x 1-3/4" height face plate with integrated over the top back design
- Fits small oval slots in 1/8" (B-Flute) to 3/16" (C-Flute) corrugated
- Also fits .148" to .177" diameter wire
- Other lengths or colors available – please inquire
- White glass filled nylon material

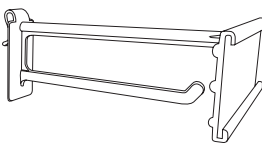
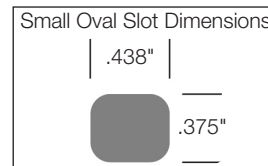

ITEM #	STEM LENGTH
107444	4"
107446	6"

Corrugated/Wire Combo Display Hooks With Scan Plate

Popular corrugated display hook having a flat front scan plate/tag section that allows for attachment of adhesive backed UPC labels, pricing or product information above merchandise. Unique over the top back design allows for use on both corrugated and wire displays. Strong plastic material adds strength so hooks resist sagging. Works with a large variety of product hole styles.

- Flat scan plate front is 1-3/8" height x 2-1/8" wide
- .141" wide x .219" height stem
- 3/4" wide x 1-3/4" height face plate with integrated over the top back design
- Fits small oval slots in 1/8" (B-Flute) to 3/16" (C-Flute) corrugated
- Also fits .148" to .177" diameter wire
- Other lengths or colors available – please inquire
- White glass filled nylon material

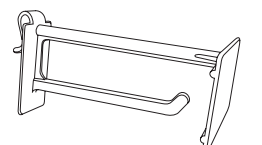
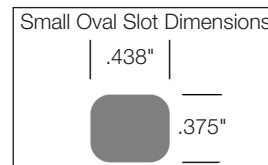

ITEM #	STEM LENGTH
107262	2"
107263	3"
107264	4"
107266	6"
107268	8"

Corrugated/Wire Combo Display Hooks

Unique over the top back design allows for use on both corrugated and wire displays. Labor saving, one piece hook that is very stable and installs easily. Strong plastic material adds strength so hooks resist sagging. Works with a large variety of product hole styles.

- .141" wide x .219" height stem
- 3/4" wide x 1" height face plate with integrated over the top back design
- Fits small oval slots in 1/8" (B-Flute) to 3/16" (C-Flute) corrugated
- Also fits .148" to .177" diameter wire
- Other lengths available – please inquire
- Glass filled nylon material

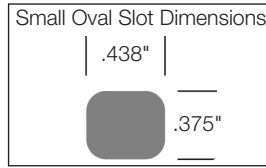

ITEM #	STEM LENGTH	COLOR
107312	2"	White
107312B	2"	Black
107313	3"	White
107313B	3"	Black
107314	4"	White
107314B	4"	Black
107315	5"	White
107315B	5"	Black
107316	6"	White
107316B	6"	Black

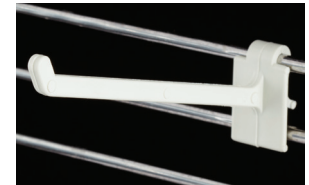

Display Hooks

Butterfly Corrugated/Wire Combo Display Hooks

Unique over the top back design allows for use on both corrugated and wire displays. Labor saving, one piece butterfly shaped hook that is very stable and installs easily. Holds packages having delta or butterfly holes. Strong plastic material adds extra strength so hooks resist sagging.

- .740" wide x .250" height stem
- 3/4" wide x 1" height face plate with integrated over the top back design
- Fits small oval slots in 1/8" (B-Flute) to 3/16" (C-Flute) corrugated
- Also fits .148" to .177" diameter wire
- Other lengths available – please inquire
- White glass filled nylon material (also available in black)

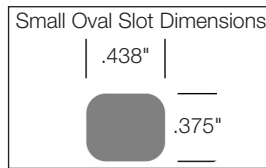

ITEM #	STEM LENGTH
107362	2"
107363	3"
107364	4"
107365	5"
107366	6"

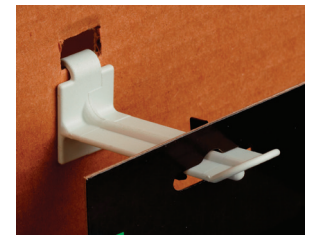
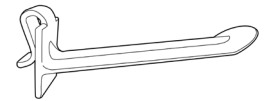

Pegboard/Slatwall Display Hooks

One of our most popular display hooks for pegboard/slatwall use. Double-rounded prong back that is both strong and extremely stable for use directly into common pegboard or slatwall. Glass-filled plastic material adds strength so hooks resist sagging. Works with a large variety of product hole styles.

- 1-1/4" wide x 1" tall V-shaped face plate with two upward facing prongs at 1" on center
- .234" stem diameter
- Integrated ridges on the stem help keep products uniformly spaced
- Fits standard 1/4" diameter pegboard holes & all standard slatwall grooves
- Other lengths available – please inquire
- Glass-filled nylon material
- Packaged 100 per bag

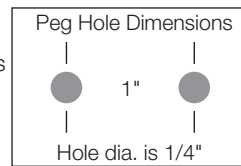

ITEM #	STEM LENGTH	COLOR
107462	2"	White
107462B	2"	Black
107463	3"	White
107463B	3"	Black
107464	4"	White
107464B	4"	Black
107466	6"	White
107466B	6"	Black
107468	8"	White
107468B	8"	Black

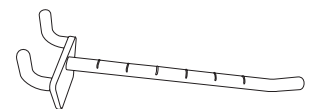

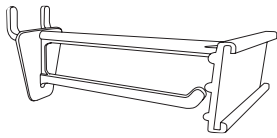

Pegboard/Slatwall Display Hooks With "C" Channel

Popular pegboard/slatwall display hook that is simple to insert while having an open face "C" channel design that accepts common data tickets, tags or signs having 1-1/4" height. Add pricing or advertisements above merchandise with little cost. Double rounded prong back design that is both strong and extremely stable for use directly into common pegboard holes or slatwall. Strong plastic material adds strength so hooks resist sagging. Works with a large variety of product hole styles.

- "C" channel size is 1-1/4" height x 3" width
- .141" wide x .219" height stem
- 1-1/4" wide x 1-3/4" height V-shaped face plate with two upward facing prongs at 1" on center
- Fits standard 1/4" diameter pegboard holes and all standard slatwall grooves
- Other lengths or colors available – please inquire
- White glass filled nylon material

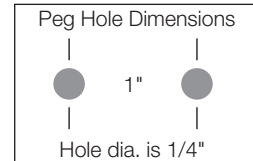

ITEM #	STEM LENGTH
107334	4"
107336	6"

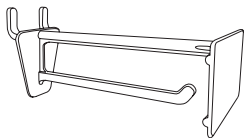

Pegboard/Slatwall Display Hooks With Scan Plate

Popular pegboard/slatwall display hook that is simple to insert while having a flat front scan plate/tag section that allows for attachment of adhesive backed UPC labels, pricing or product information above merchandise. Double rounded prong back design that is both strong and extremely stable for use directly into common pegboard holes or slatwall. Strong plastic material adds strength so hooks resist sagging. Works with a large variety of product hole styles.

- Flat scan plate front is 1-3/8" height x 2-1/8" wide
- .141" wide x .219" height stem
- 1-1/4" wide x 1-3/4" height V-shaped face plate with two upward facing prongs at 1" on center
- Fits standard 1/4" diameter pegboard holes and all standard slatwall grooves
- Other lengths or colors available – please inquire
- White glass filled nylon material

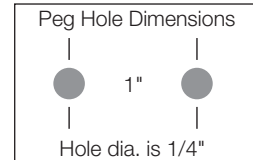

ITEM #	STEM LENGTH
107342	2"
107344	4"
107346	6"

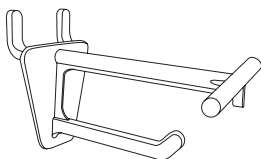

Pegboard/Slatwall Display Hooks With T-Scan Bar

Popular pegboard/slatwall display hook that is simple to insert while having a "T" style scan bar peg hook front that allows for attachment of flip info strip label holders (sold separately – see page 45). Double rounded prong back design that is both strong and extremely stable for use directly into common pegboard holes or slatwall. Strong plastic material adds strength so hooks resist sagging. Works with a large variety of product hole styles.

- T-scan peg hook bar front is .187" diameter x 1-1/2" wide
- .141" wide x .219" height stem
- 1-1/4" wide x 1-3/4" height V-shaped face plate with two upward facing prongs at 1" on center
- Fits standard 1/4" diameter pegboard holes and all standard slatwall grooves
- Other lengths or colors available – please inquire
- White glass filled nylon material

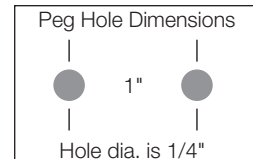

ITEM #	STEM LENGTH
107282	2"
107284	4"
107286	6"

All-Wire Pegboard Hook With Gripper

Sturdy all-wire hook for pegboard or slatwall with a gripper on the end. Used for holding signs in vertical (flag) position, extending 12" outward to capture customer attention. Gripper fins hold signs securely. Use two or more pieces for larger signs or blade signs.

- Comes fully assembled
- Gripper is 3" high and 3/4" wide
- Hook is zinc plated steel material
- Other sizes and finishes available – please inquire

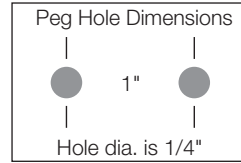

ITEM #	WIRE GAUGE	GRIP CAPACITY	STEM LENGTH
109559	.149" dia. (9 ga.)	.080"	11-1/2"

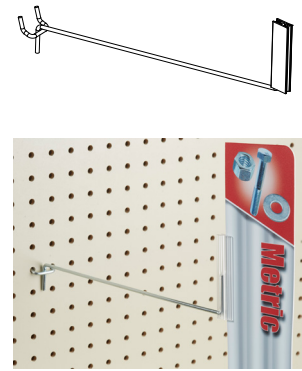

Peg Hook Product Stop

Inexpensive, triple-hole size, product back stop that keeps merchandise faced forward on most sizes/ styles of metal hooks – including hooks with safety ball tips. Gives a full stock appearance. Friction fits around a wide range of common metal hook gauges/diameters and slides forward for perfect placement. Unlike plastic inventory control units, rubber will not become brittle with the potential to crack or break over time.

- Can be used both as an inventory control unit or a product stop
- Fits multiple hook sizes, from 9 gauge (.149" dia.) to 3 gauge (.250" dia.)
- 7/64" thick
- Black rubber material
- Packaged 250 per bag

ITEM #	O.D.	COLOR
107508B	15/16"	Black

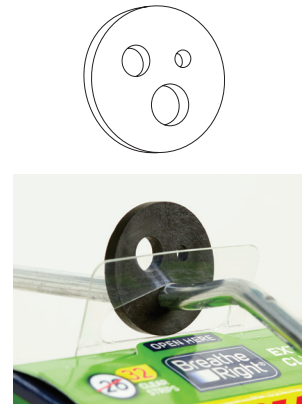

Display Hook Product Stop

Inexpensive stop that secures pre-loaded products onto all lengths of our plastic Corrugated Display Hooks (sold separately) during shipment. Flexible design that easily presses into place – attaches and detaches quickly.

- .040" thick
- Round shape with a center cross-cut hole
- Natural low-density polyethylene material

ITEM #	O.D.
107502	1"



Butterfly Hook Product Stop

Inexpensive stop that secures pre-loaded products onto all lengths of our plastic Butterfly Display Hooks (sold separately) during shipment. Flexible design that easily snaps into place – attaches and detaches quickly.

- Flexible butterfly shape
- Black PVC material

ITEM #	DIMENSIONS
107503	1-1/4" Wide x 1/4" Long



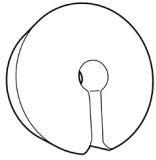

Round Inventory Control Unit

Inexpensive back stop clip that keeps merchandise faced forward on most sizes/styles of plastic and metal hooks giving a full stock appearance. Unlike plastic inventory control units, flexible vinyl will not become brittle with the potential to crack or break over time. Easily friction fits around hook and slides forward for perfect placement. No need to remove merchandise – simply slide over hooks.

- .300" thick
- Slotted side opening
- Works with most peg and slatwall hooks
- Can be used as an inventory control unit or a product stop
- Flexible vinyl material
- Custom colors available

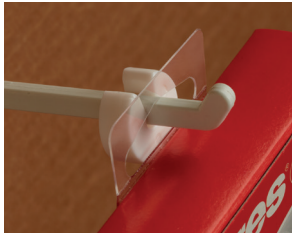

ITEM #	O.D.	COLOR
107504	3/4"	White
107504B	3/4"	Black
107504C	3/4"	Clear



Squeeze Style Inventory Control Unit

Flexible squeeze clip keeps merchandise faced forward on most sizes/styles of metal and plastic display hooks, giving a full stock appearance. Simply squeeze wings to open clip for easy attachment to hooks. Unlike plastic inventory control units, flexible vinyl will not become brittle with the potential to crack or break over time. Easily friction fits around hook and slides forward for perfect placement. No need to remove merchandise – simply slide over hooks. Removable and reusable.

- .375" thick
- Two sizes to choose from that work with most standard metal and plastic display hooks
- Can be used as an inventory control unit or a product stop
- Flexible vinyl material



ITEM #	WIRE GRIP RANGE	OVERALL HEIGHT	COLOR
107506W	.162" to .207"	13/16"	White
107507B	.200" to .280"	13/16"	Black



Inventory Control Unit

Inexpensive, dual-hole size, back stop clip that keep merchandise faced forward on most sizes/styles of plastic and metal hooks. Gives a full stock appearance. Easily friction fits around a wide range of hook diameters and slides forward for perfect placement. No need to remove merchandise – simply slide over hooks.

- Expandable opening with integrated two hole diameters
- Works with most peg and slatwall hooks
- Can be used as an inventory control unit or a product stop
- Natural polypropylene material
- Packaged 100 per bag

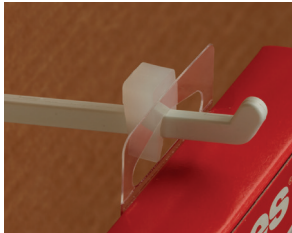

ITEM #	DIMENSIONS
107505	3/8" Wide x 3/4" Height x 5/16" Thick

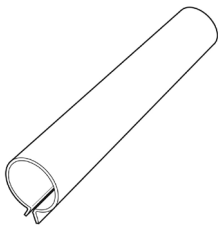

Inventory Control Tube

Fixed length inventory spacer that keeps merchandise faced forward on most sizes/styles of hooks giving a full stock appearance. No need to remove merchandise – simply slide over hooks. Use one or multiple tubes to fit various hook lengths.

- 1/2" inside diameter
- Flared leg opening works with most peg, slatwall and display hooks
- Custom lengths available
- White ABS material



ITEM #	OVERALL LENGTH
107500	2"
107501	3"

Stop Lock For Stem Hooks

Save money by deterring theft of pegged merchandise. Secure stop lock attaches to common metal stem-style hooks. Controlling inventory is quick and easy with magnetic key #109527 (sold separately).

- To install, simply open the hinged lock, place lock around the hook, and snap shut
- Works on our metal display hooks having wire diameters of 7 gauge (0.177" to 0.187") to 4 gauge (0.212" to 0.225")
- Overall size is 1-1/2" height x 3/4" wide
- Red or black color provides notice to customers that product is locked and protected

ITEM #	FOR USE ON	COLOR
109526	Stem Hooks	Red
109526B	Stem Hooks	Black



Display Hooks

Stop Lock For Loop Hooks

Save money by deterring theft of pegged merchandise. Secure stop lock attaches to common metal loop-style hooks. Controlling inventory is quick and easy with magnetic key #109527 (sold separately).

- Works on loop hooks up to .250" wire
- Overall size is 1.38" height x 1.79" wide
- Bright color provides notice to customers that product is locked and protected

ITEM #	FOR USE ON	COLOR
109626	Loop Hooks	Red

NEW

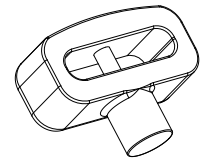

Magnetic Key For Stop Locks

- Required to detach Kinter stop locks (sold separately)
- Controlling inventory made quick and easy
- Includes a handy built-in keychain
- 2" long with 7/8" wide tapered screw cap

ITEM #	COLOR
109527	Silver

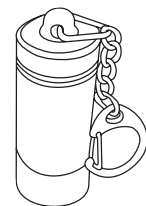

NEW

Anti-Sweep Metal Hook With T-Scan Bar

Deter product sweeping with this specialized metal peg hook. It uses a built-in hump and upturn end to allow only one product to be removed at a time. Hang in standard pegboard, and prevent theft/tampering with our Security Peg Back Lock #200009 (sold separately).

- An economical and effective way to enhance loss prevention
- Works as a normal peg hook when single products are removed
- No tools required for installation
- Security Peg Back Lock and label holders sold separately

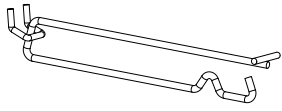

ITEM #	WIRE GAUGE	STEM LENGTH	FINISH
200026	.212" dia. (4 ga.)	6"	Galvanized
200028	.212" dia. (4 ga.)	8"	Galvanized
200020	.212" dia. (4 ga.)	10"	Galvanized
200009	Security Peg Back Lock	n/a	Galvanized

NEW

Take-One Metal Hook With T-Scan Bar

Deter product sweeping with this specialized metal peg hook. It uses a "stop trigger" mechanism to allow only one product to be removed at a time. Hang in standard pegboard using Kinter #107734 Speedy-Back Adapter (sold separately), and prevent theft/tampering with our Security Peg Back Lock #200009 (sold separately).

- An economical and effective way to enhance loss prevention
- Works as a normal peg hook when single products are removed
- No tools required for installation
- Pegboard adapters and label holders sold separately

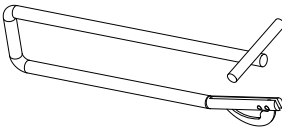

ITEM #	STYLE	WIRE GAUGE	STEM LENGTH	FINISH
200016	Take-One Hook	.212" dia. (4 ga.)	6"	Zinc
200018	Take-One Hook	.212" dia. (4 ga.)	8"	Zinc
200010	Take-One Hook	.212" dia. (4 ga.)	10"	Zinc
107734	Speedy-Back Adapter	.212" dia. (4 ga.)	n/a	Gray
200009	Security Peg Back Lock	n/a	n/a	Galvanized

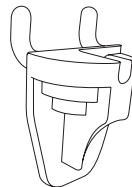

#107734 Speedy-Back Adapter
required (sold separately)

NEW

Security Peg Back Lock

Connect hooks to standard pegboard to prevent theft or tampering. Simply slide bracket over the hook and secure using the included Heavy Duty Expand-A-Lock (Kinter #120399W). Fasteners expand in pegboard and lock in place.

- Steel security bracket is 1-1/8" wide x 2-1/2" height
- White fasteners included; black fasteners available upon request
- Each sealed polybag contains 25 brackets and 25 fasteners
- Additional fasteners sold separately

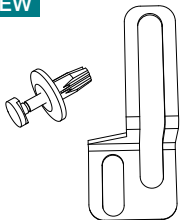

ITEM #	CONTENTS
200009	25 Security Brackets and 25 White Fasteners



Product Merchandising



NEW

K-Lock® Security Tethers – Standard Duty

- Deter shoplifters with security tethers for handheld merchandise
- Ideal for electronics, power tools and more
- 1/32" x 36" long nylon coated cable with various end styles (see chart)
- Tethers retract automatically when not pulled
- High-impact plastic boxes measure 1-5/8" length x 1-5/8" width x 5/8" height
- Use the adhesive backing to attach to flat surfaces, or mount to metal shelves using Kinter screw #4N100SPPDZ (sold separately) using the two mounting holes

ITEM #	END STYLE	FUNCTION	BOX COLOR
200030B	Grommet End	Grommet end (0.2" dia. hole) can be screwed or riveted to merchandise	Black
200031B	Loop End	Adjustable loop end (Allen wrench included)	Black
200032B	Collar End	Adjustable loop end with adjustable stop point for tether (Allen wrench included)	Black
200033B	Round End	Firm round end with adhesive (1" dia.) attaches to merchandise	Black
200034B	Flex End	Flexible round end with adhesive (1" dia.) attaches to oddly shaped merchandise	Black
200035B	Ball End	Cable ball tip (0.15" dia.) is an internal locking mechanism for merchandise	Black

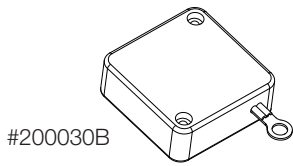

#200030B

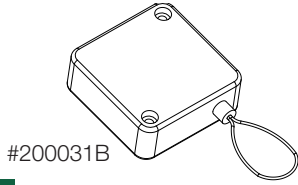

#200031B

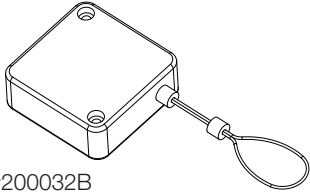

#200032B

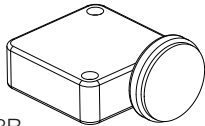

#200033B

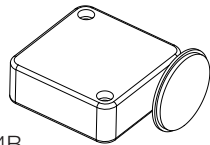

#200034B

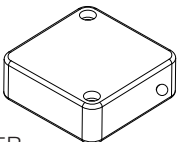

#200035B

Product Merchandising

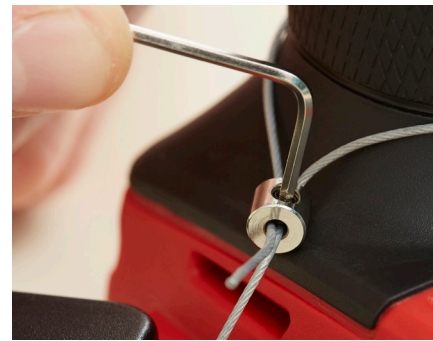
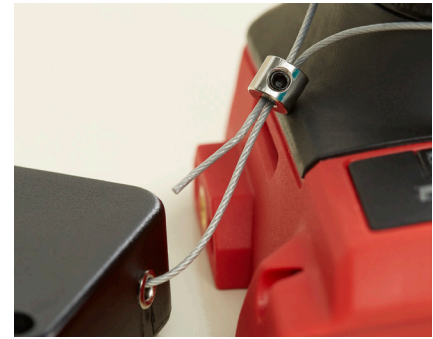

#200030B



#200031B



#200032B



#200033B



#200034B



#200035B



Magnetic Shelf System – Divider

Durable, non-adhesive dividers keep products organized on the shelf. Magnetic dividers provide a quick and easy way to organize merchandise. Dividers can be installed throughout the shelf and, unlike adhesive dividers, are easily removed or repositioned. Shelf management made easy.

- 1" wide "T" base with attached magnetic tape
- Clear construction ensures visibility of merchandise
- Features radius corners and an extra lip along the top edge for safety
- Other sizes and base colors available - please inquire
- Clear PVC material

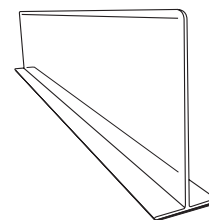

	ITEM #	STYLE	HEIGHT	LENGTH
NEW	140109	Divider ("T" Base)	3"	10"
NEW	140110	Divider ("T" Base)	3"	12"
	140688	Divider ("T" Base)	3"	14"
NEW	140111	Divider ("T" Base)	3"	16"
NEW	140112	Divider ("T" Base)	3"	18"
NEW	140113	Divider ("T" Base)	3"	20"
NEW	140114	Divider ("T" Base)	3"	22"
NEW	140115	Divider ("T" Base)	3"	24"
NEW	150000	Divider ("T" Base)	1-1/2"	10"
NEW	150001	Divider ("T" Base)	1-1/2"	12"
NEW	150002	Divider ("T" Base)	1-1/2"	14"
NEW	150003	Divider ("T" Base)	1-1/2"	16"
NEW	150004	Divider ("T" Base)	1-1/2"	18"
NEW	150005	Divider ("T" Base)	1-1/2"	20"
NEW	150006	Divider ("T" Base)	1-1/2"	22"
NEW	150007	Divider ("T" Base)	1-1/2"	24"



Front fence, divider and end cap all sold separately

Product Merchandising

Magnetic Shelf System – End Cap

Durable, non-adhesive end caps keep products organized on the shelf. Magnetic end caps provide a quick and easy way to display merchandise. End caps can be installed on shelf edges and, unlike adhesive dividers, are easily removed or repositioned. Shelf management made easy.

- 1" wide "L" base with attached magnetic tape
- Clear construction ensures visibility of merchandise
- Features radius corners for safety
- Other sizes and base colors available - please inquire
- Clear PVC material

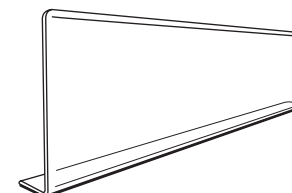

	ITEM #	STYLE	HEIGHT	LENGTH
NEW	140116	End Cap ("L" Base)	3"	10"
NEW	140117	End Cap ("L" Base)	3"	12"
	140689	End Cap ("L" Base)	3"	14"
NEW	140118	End Cap ("L" Base)	3"	16"
NEW	140119	End Cap ("L" Base)	3"	18"
NEW	140120	End Cap ("L" Base)	3"	20"
NEW	140121	End Cap ("L" Base)	3"	22"
NEW	140122	End Cap ("L" Base)	3"	24"
NEW	150010	End Cap ("L" Base)	1-1/2"	10"
NEW	150011	End Cap ("L" Base)	1-1/2"	12"
NEW	150012	End Cap ("L" Base)	1-1/2"	14"
NEW	150013	End Cap ("L" Base)	1-1/2"	16"
NEW	150014	End Cap ("L" Base)	1-1/2"	18"
NEW	150015	End Cap ("L" Base)	1-1/2"	20"
NEW	150016	End Cap ("L" Base)	1-1/2"	22"
NEW	150017	End Cap ("L" Base)	1-1/2"	24"



Front fence, divider and end cap all sold separately



#140703

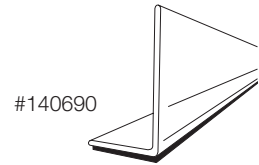

#140690

Magnetic Shelf System – Front Fence

Durable, non-adhesive front fences keep products organized on the shelf. Front fences provide a quick and easy way to display merchandise. Unlike adhesive styles, magnetic front fences are easily removed or repositioned. Shelf management made easy.

- 1" wide "L" base with attached magnetic tape
- Clear construction ensures visibility of merchandise
- #140703 is dual purpose, featuring both magnetic tape and eight .250" slotted holes for optional attachment with Kinter #120450B shelf fastener (sold separately)
- Other sizes and base colors available - please inquire
- Clear PVC material

ITEM #	STYLE	HEIGHT	LENGTH
140703	With Mounting Holes	1-1/2"	47-7/8"
140690	No Holes	1-1/2"	47-7/8"



Front fence, divider and end cap all sold separately

Contoured Shelf Divider

Simple and inexpensive shelf management system that can be used to separate or hold products in place. Use in conjunction with our line of Contoured Low Profile Front Fences (sold separately) to organize nearly any product on flat shelving surfaces. Crystal clear divider that clips onto front fence and is easily repositioned with no need for shelving fasteners or installation tools.

- Shown with 7/16" height 90 degree low profile front fence
- Two lengths to choose from, both featuring 2 inch break-off segments to fit standard shelving
- Additional heights or lengths available – please inquire
- Clear high impact plastic material

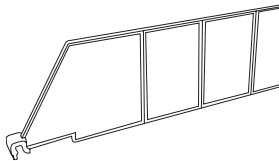

ITEM #	HEIGHT	LENGTH	FITS SHELF DEPTH
150190	3"	16"	10" thru 16"
150191	3"	22"	10" thru 22"

Contoured Magnetic Back Shelf Gripper

Optional part of a simple and inexpensive shelf management system that can be used to separate or hold products in place. Use in conjunction with the rear bottoms of our contoured shelf dividers (sold separately) to securely place and align product on flat shelving surfaces. Gripper fins combine with a strong, low-profile neodymium magnet for pinpoint placement that is not reliant on back shelf perforations, thus minimizing gaps and increasing the number of facings per shelf. **Warning:** Magnets should not be used near electronic equipment.

- Super strong and compact
- 5/8" height x 1" length x 1/2" width
- .125" to .187" grip capacity
- Clear PVC gripper attached to a nickel plated neodymium magnet

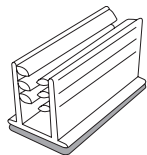

ITEM #	LENGTH	FOR USE WITH
107085	1"	Contoured Shelf Dividers

Contoured Low Profile Front Fence

An economical, self-adhesive shelf management system that is crystal clear. Use with our Contoured Shelf Dividers (sold separately) to separate or hold products in place on flat shelving surfaces. Low profile height allows for an unobstructed view of products while helping deter "shelf-sweeping" method of theft.

- 47-3/4" overall length to fit common 48" long shelves
- 7/16" height x 1/2" shelf attachment width having foam tape adhesive
- Shown with Contoured Shelf Divider (sold separately)
- Clear high impact plastic material

ITEM #	FITS SHELF SIZE	FENCE STYLE
108767	48"	90 Degree

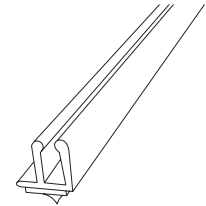

Contoured Front Fence

Heavy duty, clear front fencing that keeps products on standard perforated shelves. For use with our popular contoured shelf dividers (sold separately) as part of our contoured shelf management system that separates and holds products in place on flat shelving surfaces. Crystal clear material that allows for an unobstructed view of products while helping deter "shelf-sweeping" method of theft.

- 47-3/4" overall length to fit common 48" long shelves
- 1-1/2" height x 1-1/4" shelf attachment width
- Dual .250" round and .250" slotted holes for shelf top mounting (suggested mounting fastener #120450 sold separately – see page 210)
- Shown with Contoured Shelf Divider (sold separately)
- Also available with adhesive and in custom lengths – please inquire
- Clear PVC material

ITEM #	FITS SHELF SIZE	FENCE STYLE
108822	48"	90 Degree

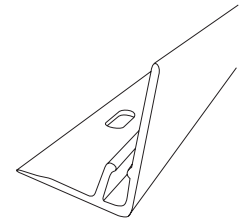

Extruded Front Fence

Two common lengths to choose from, both of which have a heavy duty, low profile front fencing that keeps products on standard perforated shelves. Also deters "shelf-sweeping" method of theft. Universal design that fits round or diamond-shaped shelf holes.

- Fits all standard 36" and 48" long perforated shelves with holes
- Shelf attachment strip is 1-1/4" height
- Dual .250" round and .250" slotted holes for shelf top mounting (suggested mounting fastener #120450 sold separately – see page 210)
- Custom lengths available
- Also available with adhesive
- Clear PETG material

ITEM #	LENGTH	FACE HEIGHT
108668	36"	1-1/2"
108669	48"	1-1/2"

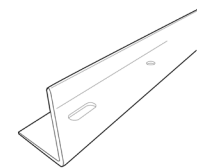

Anti-Skid Divider

Durable, non-adhesive divider keeps products organized on the shelf. Thin rubber tracks under the base provide friction to prevent dividers from sliding. Soft rubber lip runs along the top edge for safety. Remove or reposition as needed.

- Actual length is 1/4" shorter than stated length
- Base is 4" wide for stability
- Walls are .070" thick, base is .080" thick
- Custom lengths available – please inquire
- Clear PVC material

ITEM #	HEIGHT	LENGTH	FITS SHELF DEPTH
150192	6"	20"	20"
150193	6"	23"	23"

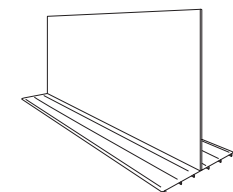

NEW

Solid Contoured Shelf Divider

A variation of our Contoured Shelf Divider, but in solid form with no breakaway sections. Simple and inexpensive shelf management system to organize or separate products. Crystal clear divider attaches to standard shelving units (fasteners sold separately).

- Radius corners for safety
- Durable .10" thick wall
- Additional heights or lengths available
- Crystal clear styrene

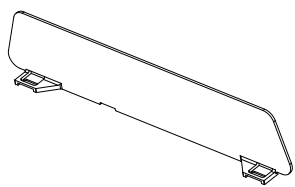

ITEM #	HEIGHT	LENGTH
150354	3"	14-1/4"

Slim-Line Shelf Divider

A very economical, self-adhesive, shelf management system that is crystal clear. Dividers can be used to separate or hold products in place. Easy to install – just peel and stick to any clean, flat shelving surface. Can be cut with scissors to any length.

- Several common shelf depths offered, with radius corners
- 1" height with 7/16" wide base at a fixed 90 degree angle
- Special clear adhesive permits removal and repositioning
- Also available in optional 3" height having 20 mil. thickness – please inquire
- Custom lengths available
- 15 mil. thick, clear rigid PVC material



ITEM #	HEIGHT	LENGTH	FITS SHELF DEPTH
150170	1"	9-1/2"	10"
150171	1"	11-1/2"	12"
150172	1"	13-1/2"	14"
150173	1"	15-1/2"	16"
150174	1"	17-1/2"	18"

Slim-Line Front Fence

Low-profile front fencing helps keep products organized on shelves. Also deters costly “shelf-sweeping” thefts. Adhesive version #140642 installs with clear adhesive tape. Non-adhesive version with holes #140884 installs with fasteners (sold separately) on standard perforated shelves.

- Clear construction ensures maximum visibility of products
- Custom lengths available
- .030" thick PETG material

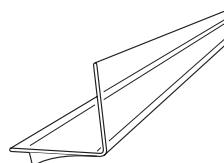

ITEM #	LENGTH	FACE HEIGHT	STYLE
140642	47-13/16"	3/4"	Adhesive
NEW 140884	47-13/16"	3/4"	Holes

Product Merchandising

Serpentine Metal Shelf Extender

Mounts on existing shelf to extend merchandise area to capture customers' attention. Place merchandising emphasis on a single shelf or shelving section. Nine evenly spaced integrated tab inserts (prongs) securely mount into most standard shelf perforations, round or diamond. Three integrated 1/4" diameter slotted holes can be used in conjunction with plastic push-in shelf fasteners (sold separately) for a more permanent fit. 1-1/4" height "C" channel front accepts UPC inserts, tags, signs and common plastic and metal sign holding clips.

- Adds extra merchandising space in a dramatic curved fashion
- Extends approximately 3" from the shelf at the center crown
- No tools required
- Beige painted steel material
- 4 pieces per box
- Sold in full boxes only

ITEM #	WIDTH	COLOR
150222	48"	Beige

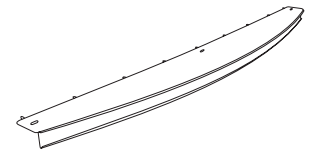

Beverage Shelf Extender

Easily mounts on existing shelf so as to extend bottled beverage merchandising and capture customer attention. Two durable wire tab inserts mount into most standard shelf perforations – round or diamond. Integrated bottom centered scan plate area can be used for attaching adhesive price tags, labels or advertisements.

- .140" wire diameter
- No tools required
- 3-1/2" inside diameter base that fits most wine bottles
- Extends into aisle approximately 4-3/8" with wrap around 3-1/4" basket height
- Scan plate is 1" height x 2" wide
- Black painted steel material
- Also available in other colors – please inquire
- Packaged 10 per box

ITEM #	INSIDE DIAMETER	INSIDE HEIGHT
150215B	3-1/2"	3-1/4"

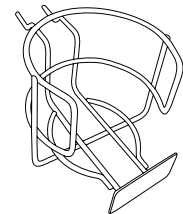

Metal Adjustable Shelf Extender

Mounts on existing shelf to extend merchandising area to capture customers' attention. Four integrated tab inserts securely mount into most standard shelf perforations, round or diamond. Built-in 9/32" diameter holes can be used in conjunction with plastic perf shelf fasteners (sold separately) for a more permanent fit.

- Adds extra merchandising space
- Extends 3-1/2" into aisle with wrap-around 3/4" lip height
- Assembled thumb screws (included) adjust shelf to desired width
- No tools required
- Beige painted steel material

ITEM #	MINIMUM WIDTH	MAXIMUM WIDTH
107118	4-7/8"	8-1/4"

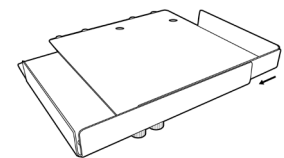

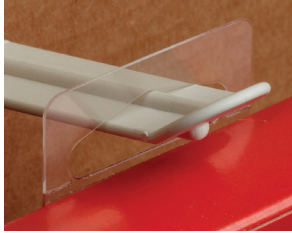
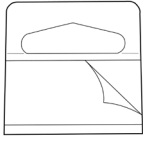

Delta Hole Hang Tab – Bulk

Versatile delta shaped hole fits almost any plastic or metal, single or double peg hook. Self-centering. Separate tabs packaged in bulk, not on a sheet or roll. Inexpensive way to hang and display unlimited types of products vertically – just peel and stick.

- .015" (15 mil) thick
- 1-1/4" delta shaped slot length
- Clear adhesive backing
- Clear plastic material
- Packaged 5,000 separate, loose tabs per box
- Sold in full boxes only

ITEM #	WIDTH	HEIGHT
150250	1-5/8"	1-7/16"

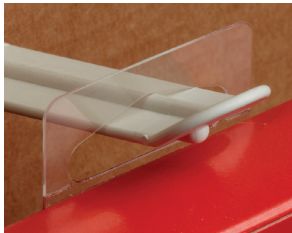
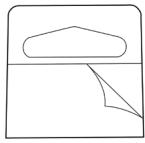

Delta Hole Hang Tab – Sheet Form

Versatile delta shaped hole fits almost any plastic or metal, single or double peg hook. Self-centering. Simple break-away tabs on sheet form. Inexpensive way to hang and display unlimited types of products vertically – just peel and stick.

- .015" (15 mil) thick
- 1-1/4" delta shaped slot length
- Clear adhesive backing
- Clear plastic material
- Packaged 20 tabs per sheet, 5,000 tabs per box
- Sold in full boxes only

ITEM #	WIDTH	HEIGHT
150251	1-5/8"	1-1/4"

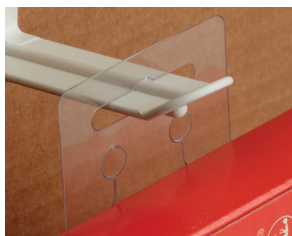
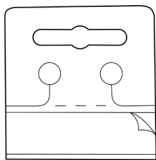

Versa-Tab With Butterfly Hole

Our most versatile butterfly hole coupon book/pad holder. Offers several convenient built-in hanging and attachment options. Mounts directly into common shelf channels or on butterfly style peg hooks. Reversible: has clear adhesive on both sides – simply peel and stick.

- .015" (15 mil) thick
- 1-1/8" long butterfly slot
- Not recommended for particle board
- Clear PVC material
- Packaged 2,000 tabs per roll
- Sold in full rolls only
- Also available on sheets – please inquire



ITEM #	WIDTH	HEIGHT
150221	1-7/8"	1-7/8"

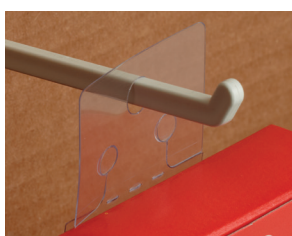
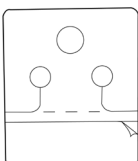

Versa-Tab Coupon Holder

Our most versatile round hole coupon book/pad holder. Offers several convenient built-in hanging and attachment options. Mounts directly into common shelf channels or on round peg hooks and wires. Reversible: has clear adhesive on both sides – simply peel and stick.

- .015" (15 mil) thick
- 5/16" diameter centered top round hole
- Not recommended for particle board
- Clear PVC material
- Packaged 2,000 tabs per roll
- Sold in full rolls only
- Also available on sheets – please inquire



ITEM #	WIDTH	HEIGHT
150220	1-11/16"	1-7/8"

Circular Hole Hang Tab – Sheet Form

Circular hole fits almost any plastic or metal single-prong peg hook. Self-centering. Break-away tabs on sheet form. Inexpensive way to hang and display unlimited lightweight products - just peel and stick.

- .010" (10 mil) thick
- 7/16" circle-shaped slot
- Adhesive backing
- Clear PVC
- Packaged 36 tabs per sheet, 5,004 tabs per box
- Sold in full boxes only

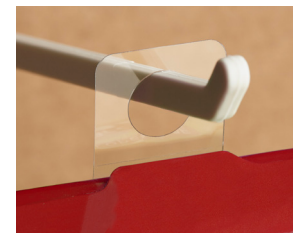
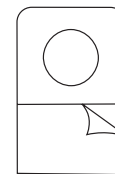

ITEM #	WIDTH	HEIGHT
150260	7/8"	1-1/4"

Re-Order Hanging Label Holder

Rectangular style adhesive label/tag holder that is ideal for product re-order notification. Ingenious clear holder that allows re-stock label information to be easily placed behind merchandise. This economical, vertical style chip has an integrated top hole and slit for quick front or side mounting directly to common single stem metal or plastic peg hooks.

- Die-cut production guarantees consistent size
- .250" diameter self centering hole size for wire peg hooks up to 1/4" diameter
- For use with adhesive labels
- .010" (10 mil) thick clear plastic material
- Packaged 100 per box
- Sold in full boxes only



ITEM #	WIDTH	HEIGHT
150252	1-1/4"	3-1/4"

Re-Order Peg Back Label Holder

Rectangular style adhesive label/tag holder that is ideal for displaying product re-order information. Clear flexible holder that allows re-stock product information to be easily viewed behind merchandise on both pegboard and slatwall. This economical chip has staggered top holes that accept common plastic or metal two prong back plates found on peg hooks. Two sets of holes at 3/4" apart allow for placement at different heights directly behind peg hook back plates.

- Holes are 1/4" diameter each at 1" on center
- Die-cut production guarantees consistent size
- For use with adhesive labels
- .010" (10mil) thick clear plastic material
- Packaged 100 per box
- Sold in full boxes only

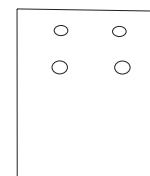

ITEM #	WIDTH	HEIGHT
150253	2-3/4"	3"

Double-Sided Peg Hook Strip

Two-sided merchandising strip that holds twice as much product. Hang and display products one above the other. Single header holes at both ends allow for multiple off-shelf mounting options such as "S" hooks and shelf top hooks, as well as metal bars, arms, or brackets with or without label scan plates. Integrated peg hook holes spaced every 1-1/4" to accommodate our line of 1-1/4" through 8" long Corrugated Universal Display Hooks (sold separately – see page 57).

- 30" long stated hanging length having an actual 29-1/4" overall extruded length
- 1-1/2" wide x 3/8" thick raised center track design for extra rigidity
- 9/32" diameter paired cross section holes and centered end holes
- Other colors, lengths and custom hole spacings available – please inquire
- Beige styrene material



ITEM #	OVERALL LENGTH	HANGING POSITIONS
130210	30"	22 on each side



Perforated Merchandising Strip

Our most economical and widely accepted retailer merchandising strip. Great for hanging and displaying lightweight products one above the other. Use in conjunction with our #108009 Perf Shelf "S" Hook (sold separately – see page 79) to hang from perforated store shelves or wire fixtures.

- 1-3/8" wide x .025" thick
- Top mounting area has a .250" diameter center hole
- Perforations and .250" diameter holes every 3 stations
- Natural high-density polyethylene material

ITEM #	OVERALL LENGTH	HANGING POSITIONS
130202	22-1/8"	12 Stations



Merchandising Strip With Removable Header

Great for hanging and displaying lightweight products one above the other. Versatile header sides are perforated and can easily be removed to form a straight retailer strip. Use in conjunction with our #108009 Perf Shelf "S" Hook (sold separately – see page 79) to hang from perforated store shelves or wire fixtures.

- Walmart® approved design
- 1-3/8" wide x .024" thick
- .250" diameter center hole at top of header
- Header label area measures 1-1/4" high x 2" wide when removable sides are left intact
- Perforations every 3 stations
- Natural high-density polyethylene material

ITEM #	OVERALL LENGTH	HANGING POSITIONS
130200	21-1/4"	12 Stations



Versa Merchandising Strip

Our most versatile merchandising strip that offers several built-in hanging/attachment options. Simply peel and stick, or combine with a plastic push-in fastener (sold separately – see pages 208-211) or metal "S" Hook (also sold separately – see page 79) for use on perforated store shelves, price channels or wire fixtures. Hang and display lightweight products one above the other.

- 1-11/16" wide x .024" thick
- Three evenly spaced .250" diameter holes at top of header
- Header has an optional use adhesive backed mounting area
- Header also has a tab area that can be snapped into standard 1-1/4" shelf price channels
- Natural high-density polyethylene material

ITEM #	OVERALL LENGTH	HANGING POSITIONS
130201	23-5/8"	12 Stations



Quick-Strip Molded Merchandising Strip

Our fastest loading merchandising strip, offering up to three times the speed. Great for hanging and displaying medium weight carded products one above the other. "Positive lock" finger feature holds pre-loaded merchandise securely during shipment. Injection molded design is stronger than conventional die-cut merchandising strips. Use in conjunction with our #108009 Perf Shelf "S" Hook (sold separately – see page 79) to hang from perforated store shelves or wire fixtures.

- Walmart® approved design without header label area
- 1-1/8" wide x .050" thick
- Top mounting area and bottom have a .250" diameter center hole
- Solid, full-length strip with no perforations
- Natural polypropylene

ITEM #	OVERALL LENGTH	HANGING POSITIONS
130218	22-1/2"	12 Stations



Quick-Strip Molded Merchandising Strip With Header

Our fastest-loading merchandising strip, offering up to three times the speed. Great for hanging and displaying medium weight carded products one above the other. "Positive lock" finger feature holds pre-loaded merchandise securely during shipment. Injection molded design is stronger than conventional die-cut merchandising strips. Use in conjunction with our #108009 Perf Shelf "S" Hook (sold separately – see page 79) to hang from perforated store shelves or wire fixtures.

- Walmart® approved design
- 1-1/8" wide x .050" thick
- Top mounting area and bottom have a .250" diameter center hole
- Header label area measures 1-3/8" high x 2" or 3" wide
- Solid, full-length strip with no perforations
- Other molded strip sizes available – please inquire
- Natural polypropylene

ITEM #	HEADER WIDTH	OVERALL LENGTH	HANGING POSITIONS
130215	2"	24-1/4"	12 Stations
130216	3"	24-1/4"	12 Stations

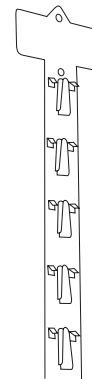

Two-Way Merchandising Strip With Header

A durable merchandising solution that works two different ways - merchandise slips over the hook, or clips underneath. Strip can be mounted to fixtures, windows or anywhere using integrated hole with hooks, fasteners or suction cups (sold separately). Cross-merchandise throughout the store and increase impulse purchases. Injection molded design is stronger than conventional die-cut merchandising strips.

- 3/4" wide x .095" thick
- Header label area measures 1-3/8" high x 3" wide
- Top mounting area has a .250" diameter center hole
- Solid, full-length strip with no perforations
- Other molded strip sizes available – please inquire
- White or black polypropylene

ITEM #	HEADER WIDTH	OVERALL LENGTH	HANGING POSITIONS	COLOR
130207	3"	31-1/8"	12 Stations	White
130207B	3"	31-1/8"	12 Stations	Black

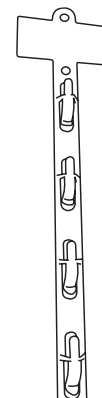

Metal Merchandising Strips

Great for hanging heavier products one above the other, especially in high traffic areas. Available in candy cane (upright) hook shape, with or without scan plate. Hang directly from wire fixtures, or use in conjunction with our Double Merchandising Strip Hanger (sold separately – see page 77) to hang from perforated store shelf tops. Integrated spring steel clips firmly attach products directly onto strips.

- Both styles have 5/8" candy cane shaped top hook openings
- Scan plate style measures 1-1/4" H x 2-1/2" L for signs or UPC labels
- .206" dia. steel, painted beige or black
- Also available with bright galvanized finish – please inquire

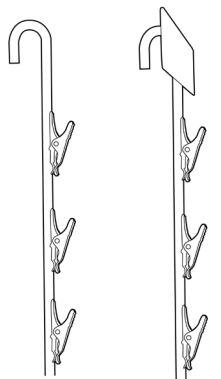

#130203

#130204



ITEM #	STYLE	OVERALL LENGTH	HANGING POSITIONS	COLOR
130203	No Scan Plate	31"	12 Stations	Beige
130203B	No Scan Plate	31"	12 Stations	Black
130204	With Scan Plate	31"	12 Stations	Beige
130204B	With Scan Plate	31"	12 Stations	Black

NEW

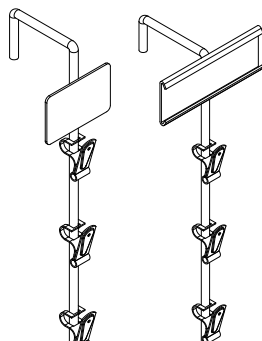

#130209

#130221

Shelf-Top Metal Merchandising Strips

Similar to our regular Metal Merchandising Strips, but hang directly over perforated shelf tops, with no other hardware needed. Great for displaying heavier items one above the other, especially in high-traffic areas. Steel clips firmly hold products.

- Square-top cane hangs over perforated shelves
- Available with scan plate for stick-on labels, or "C" channel for slide-in labels. Scan plate measures 1-3/8" height x 2-1/8" wide; "C" channel measures 1-1/4" height x 3-1/2" wide
- Sturdy 0.212" dia. steel pole, painted beige
- Available in other lengths or colors – please inquire

ITEM #	STYLE	OVERALL LENGTH	HANGING POSITIONS	COLOR
130209	With Scan Plate	19-3/4"	7	Beige
130221	With "C" Channel	31-3/4"	12	Beige



#130209



#130221

Merchandising Strip Hanger For Cooler Door

Securely hang merchandising strips from most cooler or freezer doors. Provides an opportunity to cross-merchandise other items. Secured with integrated, high bond adhesive tape on the underside. Simply peel off the adhesive liner and stick to the top of any clean, smooth door surface. Integrated, small rubber pad helps prevent against scratching of glass.

- Includes hanger tab and 9/32" centered hole to hang strips or hooks
- Tape is high tack, acrylic based adhesive that reaches maximum strength within 24 hours
- 18 gauge (.048" thick) metal
- Bright chrome finish

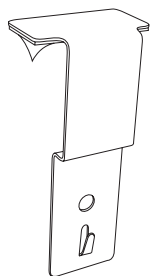

ITEM #	OVERALL LENGTH	WIDTH
107146	4"	1-1/4"

Under-Shelf Hardware-Mount Merchandising Hanger

Great for hanging double-sided or heavier style merchandising strips extended into the aisle. The base fits the underside of most perforated shelves using the included zinc plated steel hardware (assembled wing nuts and screws); thus, no interference with product on shelves. Shown with our Heavy Duty "S" Hook #108000 (sold separately – see page 79).

- Extends 4-1/2" from shelf edge
- Built-in display plate accepts labels up to 2" height x 2" wide with a .266" hole size
- Includes two assembled 10-24 x 3/4" Phil/Slot combo truss head machine screws and 10-24 wing nuts
- Screws and wing nuts are zinc plated steel material
- Hanger is beige painted steel material

ITEM #	OVERALL LENGTH	HEIGHT
107117	6"	2-1/2"

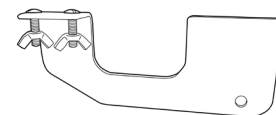

Double Merchandising Strip Hanger

Shelf top hanger that offers two ways to hang merchandising strips two at a time for double the exposure: with integrated hanger tabs, or via the side holes with common "S" Hooks (sold separately) and/or metal hook-style merchandising strips (also sold separately). Easily fits into most perforated shelf holes. Extends into the aisle to capture customers' attention. Metal offers more strength and durability than plastic or wire shelf top merchandising strip hangers. Removable and reusable.

- Holds any of our metal or plastic merchandising strips
- Top and both sides have .250" diameter centered holes
- 1-1/4" wide x 4-3/4" overall length shelf top plate
- Sides offer maximum label placement space of 1-5/16" H x 2" W
- Also available in black – please inquire
- 16 gauge (.060") thick metal

ITEM #	OVERALL LENGTH	FINISH
107121	4-3/4"	Zinc Plate
107122	4-3/4"	Painted Beige

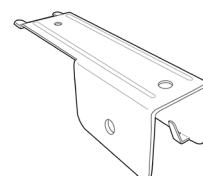

Shelf-Top Hook For Flag Or Flush Merchandising

Securely hang merchandising strips from most perforated metal shelf holes. Two styles to choose from: "flag" which holds strips perpendicular (vertical) to the shelf front, and "flush" which holds strips parallel (horizontal) to the shelf front. Unlike with common Perf Shelf "S" Hooks, there is no chance of merchandising strips becoming dislodged. Removable and reusable.

- .135" wire diameter
- Zinc plated steel

ITEM #	STYLE	OVERALL LENGTH
108035	Flag	3-1/2"
108036	Flush	4"

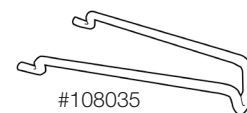

#108035

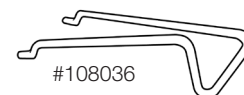

#108036



#108036



#108035

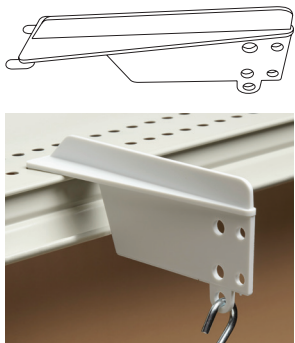

Shelf-Top Merchandising Strip Hanger – Plastic

Shelf top hanger that fits easily into most perforated shelf holes and extends into the aisle to capture customers' attention. Compatible with our Heavy Duty "S" Hook and Double "S" Hook (sold separately – see page 79) to hang single or back-to-back merchandising strips as desired. Otherwise known as Tri-Barker 90 degree shelf bracket. Removable and reusable.

- Contains five holes for various hanging applications: Two holes at .203" and three holes at .266"
- Extends 4" from shelf via two integrated hanger tabs
- Includes maximum 1-3/8" high x 3-1/4" wide label area on both sides
- White glass filled nylon material

ITEM #	OVERALL LENGTH	OVERALL HEIGHT
107995	5"	2"

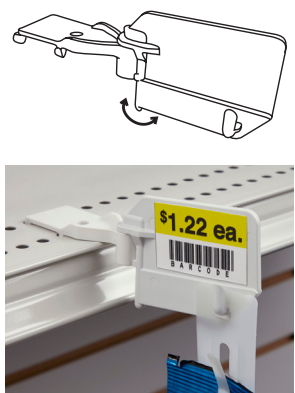

Shelf-Top Swivel Merchandising Strip Hanger

Shelf-top hanger that offers a way to hang two merchandising strips back-to-back at one time for double the exposure via integrated hanger tabs. Fits easily into most perforated shelf holes. Extends into the aisle to capture customers' attention. Ingenious swivel action protects customers and products below. Removable and reusable.

- Holds any of our plastic merchandising strips
- Base fits both common round and diamond shaped perforated shelf holes at 1" on center
- Sides offer maximum label placement space of 1-3/8" height x 2-1/8" wide
- Holds up to 8 pounds
- Parts come unassembled
- White glass filled nylon material
- Packaged 100 bases and 100 merchandising hangers per bag

ITEM #	OVERALL ASSEMBLED LENGTH	OVERALL HEIGHT
109545	5-1/4"	2-1/8"

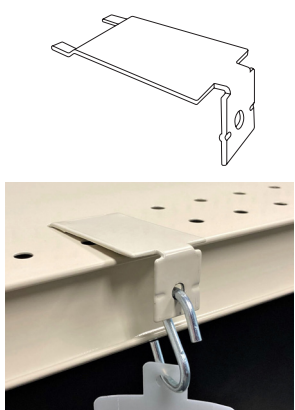

Metal Shelf-Top Bracket

Easily fits into most perforated shelf holes. Hole in face plate is great for "S" Hook use when holding heavier product merchandising strips in flush position. Metal offers more strength and durability than plastic shelf-top brackets. Removable and reusable.

- 1-1/4" wide x 2-3/4" overall length shelf-top plate
- 90 degree, 3/4" wide x 15/16" long face plate
- 3/16" diameter bottom centered mounting hole
- 16 gauge (.060") thick metal, painted beige

ITEM #	FACE PLATE LENGTH	HOLE DIAMETER
116800	15/16"	3/16"



Shelf Extender Clip

Use either of two ways to extend above or below shelf to mount a variety of signs, coupon books or lightweight displays. Hole is perfect for use with "S" Hooks (sold separately – see page 79) to hang Merchandising Strips (sold separately – see pages 74-75).

- 1" long x 1-7/8" overall height
- Two styles: with 1/4" diameter hole or with 1" height adhesive face
- Fits all standard 1-1/4" shelf price channels/rails
- Also available in custom lengths
- White butyrate material

ITEM #	STYLE
107127	with 1/4" Hole
107128	with Adhesive

Perf Shelf “S” Hooks

These extra large “S” Hooks are specially designed for hanging merchandising strips from perforated shelving. The “pinched” style prevents the hook from falling off of pre-assembled strips during shipment.

- 1-3/4" long
- .080" wire diameter
- Bright galvanized steel
- Packaged 500 per bag

ITEM #	STYLE
108009	Standard
108029	Pinched



#108009

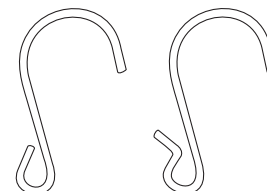

#108009

#108029



#108029

“S” Hooks

Nice range of common lengths and diameters for various hanging applications.

- Steel material, stocked in the finishes listed below

ITEM #	WIRE DIAMETER	LENGTH	FINISH
108003	.080"	1"	Bright Galvanized
108003B	.080"	1"	Black Oxide
108004	.093"	7/8"	Bright Galvanized
108005	.120"	1-5/16"	Bright Galvanized
108006	.135"	1-5/8"	Bright Galvanized
108007	.148"	2"	Bright Galvanized
108008	.177"	2-7/8"	Bright Galvanized

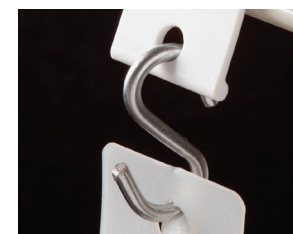

Heavy Duty “S” Hook

This extra strong “S” hook is designed for hanging heavy merchandising strips or peg hook strips from our Under-Shelf Hardware-Mount Merchandising Hanger #107117 (sold separately).

- Bottom opening is a bit larger than top opening
- Bright galvanized steel material

ITEM #	WIRE DIAMETER	LENGTH
108000	.193"	1-3/4"



Double “S” Hook

This evenly balanced and extra strong double “S” style hook is specifically designed for hanging two merchandising strips, or peg hook strips, back to back from our Under-Shelf Hardware-Mount Merchandising Hanger #107117 (sold separately – see page 77).

- Both hook openings are equal in size and are a mirror image of each other
- Bright galvanized steel material

ITEM #	WIRE DIAMETER	LENGTH	WIDTH
107999	.156"	1-3/4"	2"

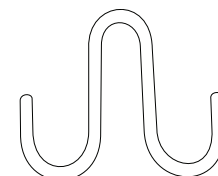

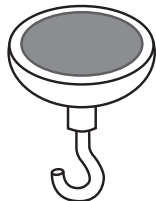

Magnetic Hooks

Display lightweight signs and products from metal surfaces. Also great for holding merchandising strips from metal surfaces. Magnets are easily placed and removed. Attaches well to most ferrous metal surfaces. **Warning:** Holding capacity is the approximate maximum pull rating under ideal conditions. Always test suitability on a per application basis. For best results, use on an indoor, bare (unfinished) metal surface that is smooth and clean. Metal conditions will affect holding power. Magnets should not be used near electronic equipment.

- All three sizes offered are 1-1/4" overall length
- Round magnet base with round metal housing with hook attachment



ITEM #	BASE O.D.	HORIZONTAL CAPACITY	HOOK OPENING	FINISH
107030	1"	9 lbs.	.187"	Powder Coated White
107031	1-1/4"	14 lbs.	.187"	Powder Coated White
107032	2"	20 lbs.	.312"	Chrome Plated

Product Merchandising

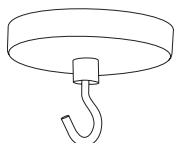

Extra Heavy-Duty Magnetic Hook

Our strongest magnetic hook, yet economical. Display signs and products from metal surfaces. Extremely strong for its 2" diameter size. Attaches to most ferrous metal surfaces. **Warning:** Holding capacity is the approximate maximum pull rating under ideal conditions. Always test suitability on a per application basis. For best results, use on an indoor, bare (unfinished) metal surface that is smooth and clean. Metal conditions will affect holding power.

- 1-13/32" overall length
- Can serve as a permanent fixture or can be removed & repositioned
- Round magnetic base with chrome plated housing with hook attachment

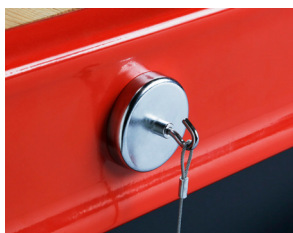

ITEM #	BASE O.D.	HORIZONTAL CAPACITY	HOOK OPENING	FINISH
109510	2"	50 lbs.	.250"	Chrome Plated

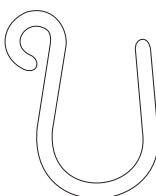

Plastic "S" Hook Merchandiser

Plastic "S" hook that is designed for hanging products from wire fixtures, baskets, fences or edging. By design, the bottom opening is much larger than the top opening. Strong yet lightweight plastic material.

- Top opening attaches to .188" - .375" diameter wire
- 1" diameter bottom hook opening
- White acetal material



ITEM #	MATERIAL DIAMETER	OVERALL LENGTH
109517	.156"	2-1/8"

Three-Level Merchandise Floor Bin

NEW

Increase your sales on loose/impulse merchandise using this sturdy, three-level bin. All levels have removable floor grates, allowing taller items to be displayed if desired. Durable yet lightweight enough to be moved or repositioned easily for various promotions. Compatible with several Kinter sign-hanging accessories – please inquire.

- Round bins are 18" diameter and 7-1/2" deep
- 7-1/4" tall opening between levels
- Three square legs with protective plastic caps on the bottom
- Friction-fit assembly with no tools required
- Black painted steel

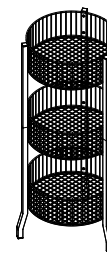

ITEM #	NUMBER OF BINS	OVERALL HEIGHT	FINISH
180031B	3	46-1/4"	Painted Black

Floral Stand With Bucket Holder

NEW

Compact floral stand has a bucket holder to sell fresh flowers (bucket not included). Easily movable to encourage sales at the checkout line or greeting card section. A heavy-duty gripper sign holder is included to display decorative signage on top.

- Circular bucket holder is heavy-duty wire, with an inside diameter of 6-1/2"
- Black gripper top is 3" wide x 1" height, holding signs 0.080" to 0.250" thick
- Four rubber feet attached to the bottom of the base
- Base is 12" x 12" square
- Black painted steel material

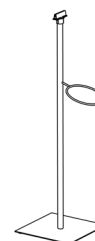

ITEM #	OVERALL HEIGHT	BUCKET HOLDER I.D.	FINISH
150406B	41"	6-1/2"	Painted Black

Wire Power Wing

NEW

Open a new world of merchandising options on high-visibility end caps. Industry standard "fixed rail" is compatible with numerous Kinter sign-hanging accessories – please inquire. Wire Power Wings mount to the ends of common perforated shelves using hardware kit #181522 (sold separately).

- 57 horizontal wires, spaced 1" outside-to-outside
- Durable 0.164" wire ideal for high-traffic areas
- 181522 mounting kit includes 2 J-clips, 2 screws and 2 wing nuts in a clear polybag
- Custom wire colors available

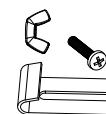
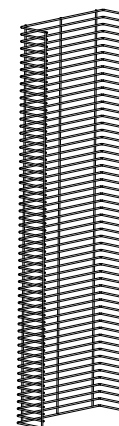

ITEM #	DESCRIPTION	WIDTH	HEIGHT	DEPTH	COLOR
181518	Wire Power Wing	14.5"	48"	4-1/2"	Beige
181518S	Wire Power Wing	14.5"	48"	4-1/2"	Zinc
181522	J-Clip Hardware Kit	n/a	n/a	n/a	Zinc



Product Merchandising

NEW

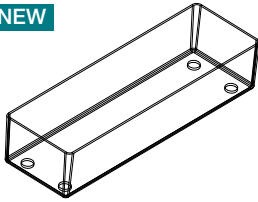

Clear Tabletop Bin

Sturdy rectangular bin attractively holds small items on tables, shelves or counters, with four “no skid” buttons attached to the bottom.

- Holds small items up to 10-1/2" wide
- Deluxe .080" thick walls
- Crystal clear styrene



ITEM #	WIDTH	HEIGHT	DEPTH
150482	11"	2-1/4"	3-1/4"

Product Merchandising

NEW

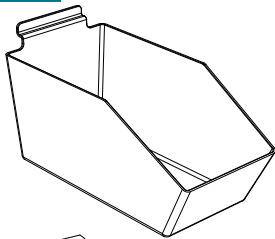

Opti-Bins & Label Holder

Clear bins hang from standard slatwall, offering easy access to merchandise. Use multiple bins or various sizes to create an attractive, multi-level display. Optional gripper label holder #150968 (sold separately) attaches to the front for adhesive or non-adhesive tags/signs.

- Bins are 6" wide x 5-1/2" high
- Three bin lengths to choose from
- Bins are clear styrene; label holder is clear PVC
- Custom sizes available – please inquire

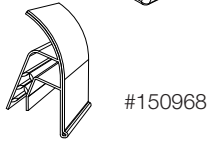

ITEM #	STYLE	SIZE	FINISH
170966	Slatwall Bin	7-1/2" Long	Clear
170967	Slatwall Bin	9-1/2" Long	Clear
170968	Slatwall Bin	11-1/2" Long	Clear
150968	Label Holder	2" Wide	Clear



NEW

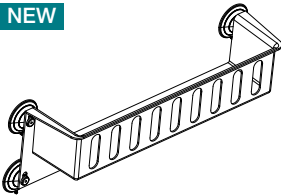

Vented Bin For Glass

Make an impact on customers – right on the cooler or freezer door. Upsell or cross-merchandise your products on glass. Great for selling ketchup, chocolate syrup, soft drinks and more. Four high-quality Kinter suction cups (included) ensure a firm hold.

- Bin features 16" of usable length
- Features a flat label area 2" height x 16-1/2" wide for optional pricing
- Four Kinter suction cups (#130604) are included, inserting into four keyholes
- Durable, clear polycarbonate material



ITEM #	WIDTH	BACK HEIGHT	DEPTH
150960	18-3/8"	6"	4-1/2"

NEW

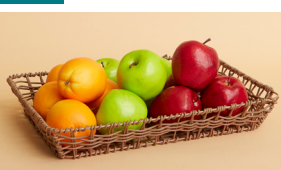

Synthetic Wicker Basket

- Attractive synthetic wicker basket enhances product display
- Wire reinforced with double-wrapped edges
- Other sizes and colors available – please inquire



ITEM #	SIZE	COLOR
180029	16" Long x 12" Wide x 2-1/2" Deep	Brown



Sign & Literature Holders



Plastic Modular Sign Frame System

Mix and match sign frames, stems and bases to achieve your vision. These interchangeable sign components are ideal for environments with ever-changing messages. Sturdy plastic holds up in high-traffic areas. All options are removable and reusable.

- Frames can be displayed in portrait or landscape orientation
- Stems friction-fit into bases and Stem-To-Frame Mounts
- Center Stem Base has four 3/16" holes for optional permanent mounting; Flat Shovel Base has no holes
- Frames, stems and bases available in white and black
- Custom sizes and colors available - please inquire

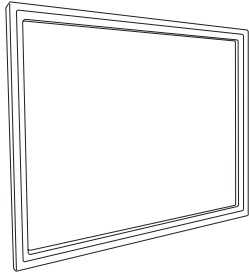

Modular Sign Frame

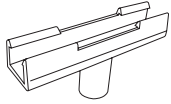

Stem-To-Frame Mount

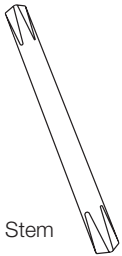

Sign Stem

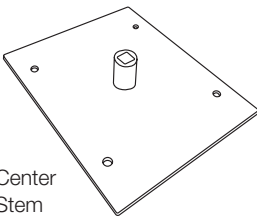

Center Stem Base

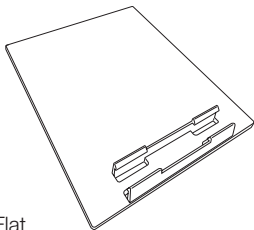

Flat Shovel Base

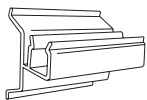

C-Channel Mount

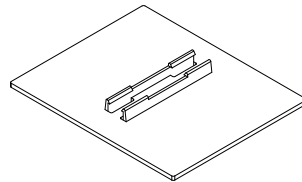

Flat Center Base

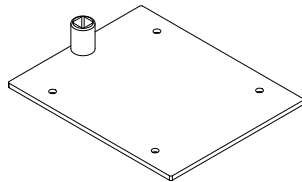

Stem Shovel Base

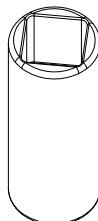

Stem Connector

ITEM #	DESCRIPTION	DIMENSIONS	COLOR
150280	Modular Sign Frame	8-1/2" x 11"	White
150280B	Modular Sign Frame	8-1/2" x 11"	Black
150281	Modular Sign Frame	7" x 11"	White
150281B	Modular Sign Frame	7" x 11"	Black
150285	Stem-To-Frame Mount	3" W	White
150285B	Stem-To-Frame Mount	3" W	Black
150288	Sign Stem	4" L	White
150288B	Sign Stem	4" L	Black
150289	Sign Stem	8" L	White
150289B	Sign Stem	8" L	Black
NEW 140990	Flat Center Base	4-1/2" x 5-1/2"	White
NEW 140990B	Flat Center Base	4-1/2" x 5-1/2"	Black
150287	Flat Shovel Base	4-1/2" x 5-1/2"	White
150287B	Flat Shovel Base	4-1/2" x 5-1/2"	Black
150286	Center Stem Base	4-1/2" x 5-1/2"	White
150286B	Center Stem Base	4-1/2" x 5-1/2"	Black
NEW 140991	Stem Shovel Base	4-1/2" x 5-1/2"	White
NEW 140991B	Stem Shovel Base	4-1/2" x 5-1/2"	Black
140830	C-Channel Mount	2" L	Clear
NEW 140989	Stem Connector	1-7/16" L	White
NEW 140989B	Stem Connector	1-7/16" L	Black



All components sold separately

Plastic Sign Frame – Shovel Base

Freestanding, heavy duty sign holder. Convenient shovel base perfect for displaying signage on end caps and bulk merchandise displays, as well as flat surfaces. Integrated holes on base can be used to fasten to shelves or other fixtures.

- Accepts single- or double-sided graphics 7" high x 11" wide
- Displays signs in landscape (horizontal) position
- Base is 4" wide x 5-3/4" long x .120" thick with tapered shovel edge
- Other sizes and colors available – please inquire
- Durable ABS material

ITEM #	FRAME HEIGHT	FRAME WIDTH	BASE STYLE	COLOR
150237B	7"	11"	Easel (Rectangular)	Black

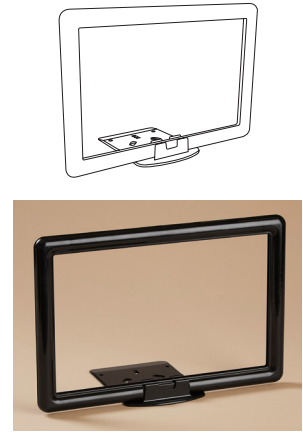

Plastic Sign Frame – Adjustable Stem

Freestanding, heavy duty telescopic sign holder. Convenient shovel base perfect for displaying signage on end caps and bulk merchandise displays, as well as flat surfaces. Integrated holes on base can be used to fasten to shelves or other fixtures.

- Accepts single- or double-sided graphics 7" high x 11" wide
- Displays signs in landscape (horizontal) position
- Stem easily ratchets up and down
- Base is 4" wide x 5-3/4" long x .120" thick with tapered shovel edge
- Other sizes and colors available – please inquire
- Durable ABS material

ITEM #	FRAME HEIGHT	FRAME WIDTH	ADJUSTABLE STEM HEIGHT	COLOR
150238B	7"	11"	20" thru 29"	Black



Snap-Down Metal Sign Frame

All four mitered frame sides open and snap down for a secure hold. Durable metal frame offers an upscale look indoors or outdoors. Back panel provides additional stability. Change graphics easily.

- Fully assembled
- Frame sides are 1" wide
- Visible graphic area is 3/4" less than listed sign size
- Accepts graphics up to 1/16" thick
- Clear plastic overlay (included) extends sign life
- Mount using integrated .200" O.D. holes on back
- Aluminum frame and back panel
- Other sizes and colors available – please inquire
- Each frame is individually boxed, complete with four screws, four wall anchors & instruction sheet

ITEM #	FRAME DIMENSIONS	STYLE	COLOR
150225	8-1/2" x 11"	Portrait or Landscape	Silver
150225B	8-1/2" x 11"	Portrait or Landscape	Black
150226	17" x 22"	Portrait or Landscape	Silver
150226B	17" x 22"	Portrait or Landscape	Black
150227	22" x 28"	Portrait or Landscape	Silver
150227B	22" x 28"	Portrait or Landscape	Black
150228	24" x 36"	Portrait or Landscape	Silver
150228B	24" x 36"	Portrait or Landscape	Black

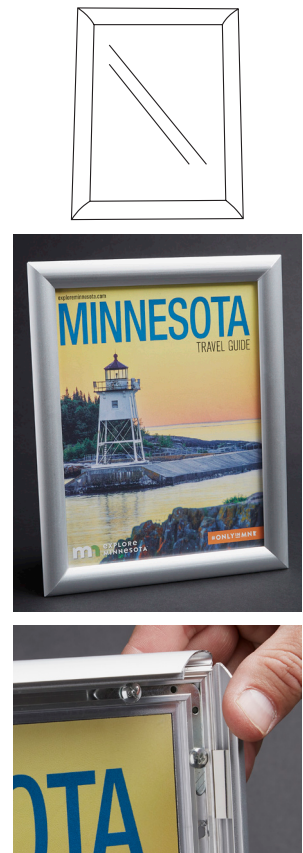

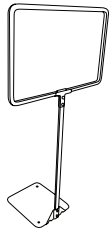

Metal Sign Frame – Fixed Stem

Freestanding sign holder that slips easily under boxes or products and can be repositioned. Solid, non-adjustable stem allows messages to be placed at even and consistent heights above shelves or countertops. Signs slide into the top opening and are held in place by an elegant, rounded corner frame.

- Heights and widths refer to the inserted graphics, not the overall frame
- For use on flat surfaces with no tools required
- Accepts signs up to .050" thick
- Sturdy 4-3/4" x 5-3/8" shovel style base with two 3/16" diameter holes
- Custom sizes and colors/finishes available – please inquire
- Black painted steel material



ITEM #	FRAME HEIGHT	FRAME WIDTH	STEM HEIGHT	FINISH
150429B	5-1/2"	7"	8"	Painted Black
150201B	7"	11"	10"	Painted Black
150202B	5-1/2"	7"	12"	Painted Black
150203B	7"	11"	12"	Painted Black
150403B	7"	11"	14"	Painted Black

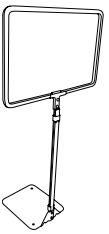

Metal Sign Frame – Adjustable Stem

Freestanding sign holder that slips easily under boxes or products and can be repositioned. Versatile built-in adjustable stem allows messages to be placed low to the countertop or rise above. Signs slide into the top opening and are held in place by an elegant, rounded corner frame.

- Heights and widths refer to the inserted graphics, not the overall frame
- For use on flat surfaces with no tools required
- Accepts signs up to .050" thick
- #150200 & #150200B have sturdy 4-3/4" x 5-3/8" shovel style base with two 3/16" diameter holes
- #150213B, #150212B & #150401B have sturdy 5" x 5-3/8" shovel style base with two 3/16" diameter holes and one 1/4" diameter hole
- Custom sizes and colors/finishes available – please inquire
- Black painted or chrome plated steel material
- Optional clear plastic sleeve #140834 available, designed specifically for #150401B (sold separately)



ITEM #	FRAME HEIGHT	FRAME WIDTH	ADJUSTABLE STEM HEIGHT	FINISH
150200	7"	11"	14" thru 22"	Chrome Plate
150200B	7"	11"	14" thru 22"	Painted Black
150213B	7"	11"	12" thru 24"	Painted Black
150212B	11"	14"	12" thru 24"	Painted Black
150401B	14"	11"	12" thru 24"	Painted Black
140834	14-1/2"	11"	n/a (Optional Protective Sleeve)	Clear Plastic



#140834 is an optional clear protective sleeve designed specifically for #150401B (both sold separately)

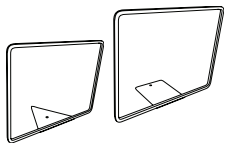

Metal Sign Frame – No Stem

Freestanding, low profile sign holder that slips easily under boxes or product directly on the shelf – simply slide the shovel base on top of the shelf and under the product. Also perfect for stacked merchandise by simply inserting the flat base between layers of product. Signs slide into the top opening and are held in place by an elegant, rounded corner frame.

- Heights and widths refer to the inserted graphics, not the overall frame
- For use on flat surfaces with no tools required
- Accepts signs up to .050" thick
- Custom sizes and colors/finishes available – please inquire
- Wedge style (triangular) base is 4-1/2" wide x 4-3/4" long and is tapered with a 3/8" diameter center hole
- Easel style (rectangular) base is 4-1/2" square and has a 1/4" diameter centered end hole
- Black painted steel material

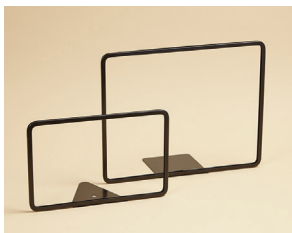

ITEM #	FRAME HEIGHT	FRAME WIDTH	BASE STYLE	FINISH
150206B	7"	11"	Wedge (Triangular)	Painted Black
150207B	11"	14"	Easel (Rectangular)	Painted Black

Metal Sign Frame – Magnetic Base

Freestanding, low profile sign holder with a versatile magnetic base that assures maximum holding power on metal surfaces. Signs slide into the top opening and are held in place by an elegant, rounded corner frame. Removable and reusable. **Warning:** Magnets should not be used near electronic equipment.

- Heights and widths refer to the inserted graphics, not the overall frame
- For use on flat metal surfaces with no tools required
- Accepts signs up to .050" thick
- Magnetic base is 7/8" wide x 7-1/2" long x 5/16" overall height
- Custom sizes and colors/finishes available – please inquire

ITEM #	FRAME HEIGHT	FRAME WIDTH	FINISH
150204	7"	11"	Chrome Plate
150204B	7"	11"	Painted Black
150205B	11"	14"	Painted Black
150400B	14"	11"	Painted Black



Counter Mat Sign Holder

Display and protect promotions or critical information on counters or other flat surfaces while preventing curled graphic corners. Provides quick-change, long lasting performance. Signs are framed evenly on all four sides by an attractive 1" wide black, radius cornered border. Clear surface is scratch resistant and provides great durability. Can be used in either portrait or landscape orientation.

- 1/16" thick, non-slip, heavy duty black rubber backing
- Sealed on three sides with the pocket opening from the long side
- Actual overall internal dimensions are slightly larger than the listed size for ease of use
- Custom sizes and border printing options available – please inquire
- 15 mil scratch resistant clear vinyl window with white background

ITEM #	GRAPHIC SIZE	OVERALL MAT SIZE
107415	8-1/2" x 11"	10-1/2" x 13"
107416	11" x 17"	13" x 19"

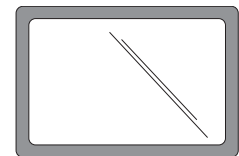

K-Ads® Shopping Cart Sign Frame

Both shatter-resistant and weather-resistant sign frame that firmly mounts to shopping carts. An affordable way to create new revenue or advertise your product directly off most spring wire or molded carts. Accommodates signs on both sides for maximum impact. Be the direct image in the customer's mind as they shop throughout the store. Once the sign frame is in place, ads can be inserted and changed with ease.

- Overall frame size is 11-1/2" wide x 7-1/2" height
- Each set comes complete with: Two frame halves, four 1/2" screws, four 3/4" screws, four locking nuts and two black 14" cable ties – which accommodates most styles of common cart baskets
- Required tools: #2 Phillips screwdriver and 3/8" hex width wrench (not included – see page 223)
- Maximum spacing between frames is 3/8"
- Accepts signs up to .050" thick
- Black shatter-resistant polypropylene material
- Additional colors available – please inquire

ITEM #	SIGN HEIGHT	SIGN WIDTH	COLOR
109505	7"	11"	Black

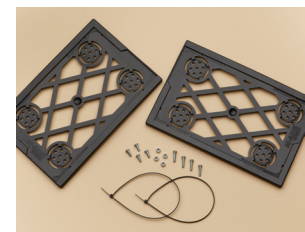
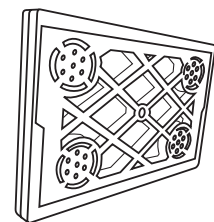

NEW

Universal Pallet Floor Sign Holders

Display promotional signs or pricing information for pallet-stacked merchandise. Simply slide the flexible wire foot into any side of a standard pallet. Signs are elevated approximately 8" off the floor and tilted backward for optimal viewing. Durable for indoor or outdoor use.

- One case includes the components for 10 complete sets: 10 metal bases, 10 sign frames and 40 sign pins (Kinter #120451B, four per frame) to hold the graphic
- Sign pins hold graphics firmly in windy conditions
- Pins can be removed and reused, but additional pins can be purchased separately if necessary
- Wire foot is black painted steel; sign base is durable black plastic
- Custom frame sizes/colors available – please inquire
- Sold in full cases only

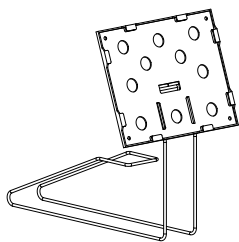

ITEM #	SIGN SIZE	COLOR
150464B	5" tall x 7" wide	Black
150465B	7" tall x 11" wide	Black
150466B	8-1/2" tall x 11" wide	Black

Sign & Literature Holders

Pallet Sign Holder – Adjustable Height

Freestanding sign holder that slips under floor displays or products on pallets and can easily be repositioned. Versatile built-in adjustable post allows messages to be placed low to products or rise above. Signs slide into the short side opening of the included free swinging, rounded corner frame. Attached hanging hooks included. Some minor assembly required.

- For use on flat floor surfaces with no tools required
- Square tubing telescopic post height adjusts from 50" through 70"
- Frame with attached top rings accepts signs up to .050" thick
- Frame hooks are 10" on center
- Sturdy 10" x 10" square base
- Black painted steel material; also available in chrome finish
- One case of #150217B comes with: 6 sign frames, 6 straight posts, 6 angled posts and 6 square bases
- One case of #150218B comes with: 2 sign frames, 2 straight posts, 2 angled posts and 2 square bases
- Sold in full cases only

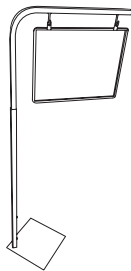

ITEM #	FRAME HEIGHT	FRAME WIDTH	ADJUSTMENT HEIGHT	FINISH
150217B	11-1/8"	14"	50" to 70"	Painted Black
150218B	7"	11"	50" to 70"	Painted Black

Reminder: Must be ordered in full cases.

Sign Board Pallet Sign Holder – Adjustable Height

Freestanding sign holder that slips under floor displays or pallets. Adjustable post allows messages to be placed low to products or rise above. Two attached hanging hooks accept our popular #109506B Spiral Sign Board (sold separately – see page 92), allowing messages to be changed easily. Some minor assembly required.

- For use on flat floor surfaces with no tools required
- Square tubing telescopic post height adjusts from 48" to 72"
- Spiral Sign Board #109506B not included and would need to be ordered separately
- Frame hooks are 19" on center
- Sturdy 10" x 10" square base
- Black painted steel material
- 2 complete sets per case
- Sold in full cases only

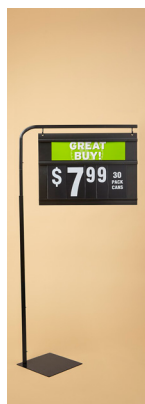
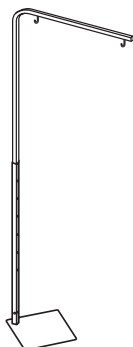

ITEM #	ADJUSTMENT HEIGHT	FINISH
150232B	48" to 72"	Painted Black

Reminder: Must be ordered in multiples of 2. Each case contains the components for 2 complete sets.

Extra Height Adjustable Pallet Sign Holder

Our tallest freestanding sign holder that slips under floor displays or products on pallets that can easily be repositioned. Versatile built-in adjustable post allows messages to be placed low to products or rise above. Two attached hanging hooks accept free swinging signs or can be used in conjunction with our popular #107414 Rigid Covered Sign Holder (sold separately – see page 172). Some minor assembly required.

- For use on flat floor surfaces with no tools required
- Recommended sign hole size is 3/8" diameter with 9" wide on center hole spacing with a maximum width of 15"
- Square tubing telescopic post height adjusts from 52" to 80"
- Rigid Covered Sign Holder #107414 not included; needs to be ordered separately
- Sturdy 10" x 12" rectangular base
- Black painted steel material
- Each case comes with 2 straight posts, 2 angled posts and 2 rectangular bases
- 2 complete sets per case
- Sold in full cases only

ITEM #	ADJUSTMENT HEIGHT	FINISH
150214B	52" to 80"	Painted Black

Reminder: Must be ordered in multiples of 2. Each case contains the components for 2 complete sets.



Floor Stand With Sign Frame & Bag Stem

Freestanding sign holder features a 12" stem to hold "take one" bags in grocery environments. Also slides under floor displays or products on pallets. Sign arm can be raised or lowered as desired, while the built-in bag stem remains fixed at 34" high. Sign frame (included) holds 11" high x 14" wide signs, with insertion/removal from the side. Some minor assembly required.

- For use on flat floor surfaces with no tools required
- Square tubing telescopic post adjusts from 52" to 66"
- Sturdy 10" x 12" rectangular base
- Black painted steel material
- 6 complete sets per case
- Sold in full cases only

ITEM #	BAG STEM	FRAME HEIGHT	FRAME WIDTH	ADJUSTMENT HEIGHT	FINISH
150404B	12"	11"	14"	52" to 66"	Painted Black

Reminder: Must be ordered in multiples of 6. Each case contains the components for 6 complete sets.

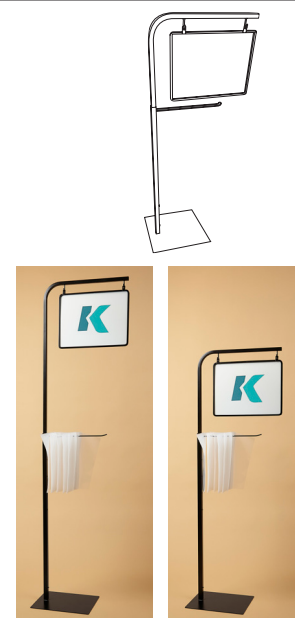

Floor Stand With Welded Top Sign

Freestanding sign holder features a fixed, welded frame on top, with extra-tall adjustment capacity. Also slides under floor displays or products on pallets. Sign arm can be raised or lowered as desired. Sign frame holds 7" high x 11" wide signs, with insertion/removal from the top. Some minor assembly required.

- For use on flat floor surfaces with no tools required
- Square tubing telescopic post adjusts from 49" to 79"
- Sturdy 10" x 10" square base
- Black painted steel material
- 6 complete sets per case
- Sold in full cases only

ITEM #	FRAME HEIGHT	FRAME WIDTH	ADJUSTMENT HEIGHT	FINISH
150405B	7"	11"	49" to 79"	Painted Black

Reminder: Must be ordered in multiples of 6. Each case contains the components for 6 complete sets.

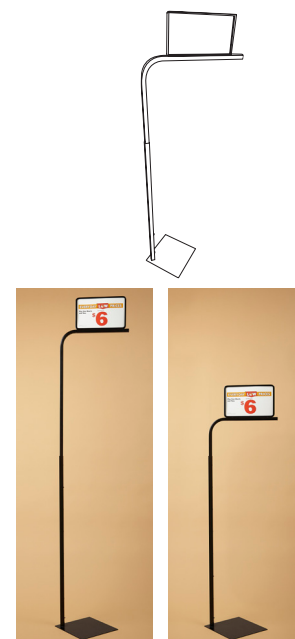

Sign & Literature Holders

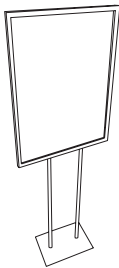

Poster Frame Floor Display Stand

Economical, freestanding two-sided sign holder floor stand offering premium size and visibility. Graphics insert into the top for easy message placement and re-placement. Sturdy round tubular uprights, coupled with a weighted rectangular base, provide excellent stability. Ships flat with some assembly required.

- Holds 22" wide x 28" height posters up to 1/4" thick
- Heavy, solid steel 14" x 10" rectangular base
- Two 31" long threaded round tubing support legs that join the frame to the base
- Black painted steel material
- All hardware and components included for one complete display stand
- Packaged 1 unit per carton



ITEM #	FRAME HEIGHT	FRAME WIDTH	OVERALL HEIGHT	FINISH
150219B	28"	22"	59"	Painted Black

Sign & Literature Holders

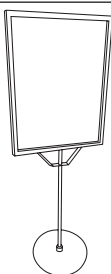

Newspaper & Ad Stand Sign Holder

Eye-catching sign holder is perfect for a grocery store entryway to help customers find sales. Shiny chrome finish makes your message stand out. Graphics insert from the top. Frame supports an optional literature basket (#150439 - sold separately) for advertisements/coupons. Some minor assembly required.

- Holds 22" wide x 28" height posters up to 1/4" thick
- 16" wide circular base
- Durable metal construction
- Optional literature basket sold separately
- Packaged 1 unit per carton



Basket sold separately

ITEM #	FRAME HEIGHT	FRAME WIDTH	OVERALL HEIGHT	FINISH
150421	28"	22"	60"	Chrome

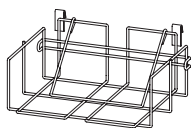

Basket For Newspaper & Ad Stand Sign Holder

Offer your customers copies of ads, coupons or specials right in store. This attractive chrome basket hangs from our Newspaper & Ad Stand Sign Holder (#150421 - sold separately). Basket features a handy flip-up bar that acts as a paperweight.

- Perfect for offering ads/coupons at store entrances
- Deep enough to support 4" of stacked literature
- Durable metal construction withstands constant use



ITEM #	BASKET LENGTH	BASKET WIDTH	BASKET DEPTH	FINISH
150439	12"	9-1/2"	4"	Chrome

Indoor/Outdoor Spring Base Floor Stand

Attract attention from one or both sides with this sturdy snap frame, indoors or outdoors. Designed to withstand winds of 20 miles per hour thanks to a heavy-duty spring system and weighted base. Fill base with water or sand if desired. Elegantly convey your message on sidewalks or parking lots, or anywhere indoors. Signs can be inserted and changed in seconds.

- Accepts signs 23-3/8" wide x 33" high
- Aluminum frames snap open and shut on both sides
- Sturdy, lightweight frame easily mounts to the base with two heavy-duty bolts
- Base features two wheels and a handle for easy transport
- Overall item height is 44-1/2"
- Packaged 1 unit per carton

ITEM #	POSTER WIDTH	POSTER HEIGHT	BASE COLOR	FRAME COLOR
109571	23-3/8"	33"	Gray	Silver

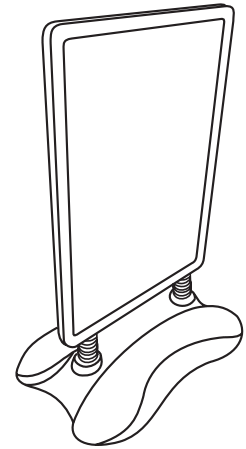

Premium Graphic Board Floor Stand

Elegant, frameless construction floor stand that is appealing in any retail environment. High quality freestanding mobile style display solution that grabs customer attention. Easily stand single-sided or double-sided rigid display graphics (not included). Heavy duty "M" shaped assembled base design that centers the weight directly and firmly on the floor. Excellent choice for in-store display.

- Accommodates rigid graphic substrates of up to 1-1/2" thick and 6 ft. in height
- 3-1/2" total height x 9" - 10" width when assembled via interior slotted holes
- Recommended graphic hole size is 1/4"
- Each set includes 10-24 diameter black plated carriage bolts and extra-tall wing nuts
- No tools required
- Matte black painted steel material
- Other colors and lengths available – please inquire
- Packaged one complete set with hardware per box

ITEM #	LENGTH	APPROXIMATE WEIGHT
150195B	24"	10-1/2 lbs.
150196B	36"	15-3/4 lbs.
150197B	48"	21 lbs.

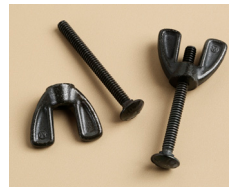
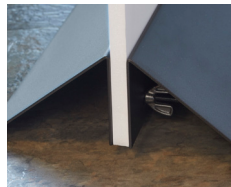

Hardware included

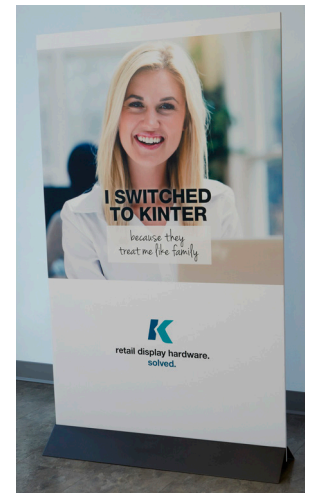
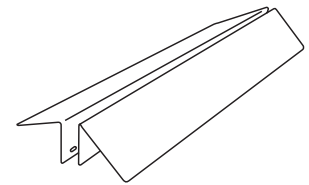

Outdoor Lawn Sign Frame

Popular metal frame commonly used to support lawn and yard signs. Features welded crossbars and ribbed sidewires for extra gripping. When pushed into the ground, with the bottom crossbar even with the earth, height is 22-1/2".

- Also known as Step Stakes or H-Stakes
- Features two crossbars for stability
- Galvanized steel material
- Other sizes available – please inquire

ITEM #	OVERALL HEIGHT	WIDTH	WIRE GAUGE
150231	30"	10"	.149" dia. (9 ga.)

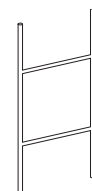

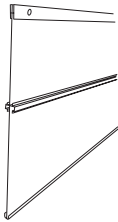

Spiral Sign Board

Extruded panel holds both promotional signs and pricing simultaneously and cost effectively. When combined with our spiral sign board brackets and pads (both sold separately), these double-sided rigid boards are ideal for gondola tops, end caps and other in-store areas with changing price points. Display numerical and/or reading pads plus message graphics from one or both sides. Also can be hung from walls, windows or ceilings via integrated holes.



- #108839 holds 7-7/8" to 8" height signs in top channel (up to 1/8" thick) and 11-1/8" height spiral sign pads in bottom channel, with two 3/8" diameter mounting/hanging holes
- #109506B holds 4-1/2" height signs in top channel (up to 5/32" thick) and 8" height spiral sign pads in bottom channel, with two 5/16" diameter mounting/hanging holes
- High impact polystyrene (HIPS) material
- One-sided boards, other lengths or colors also available – please inquire
- Packaged 10 per box

ITEM #	OVERALL LENGTH	OVERALL HEIGHT	TOP CHANNEL HOLDS	BOTTOM CHANNEL HOLDS	COLOR
108839	34"	20-3/8"	7-7/8" to 8" H Signs	11-1/8" H Spiral Sign Pads	White
109506B	21"	15-3/8"	4-1/2" H Signs	8" H Spiral Sign Pads	Black

Spiral Sign Board Pads

Durable plastic pages that are spiral bound into tablets. Feature a variety of quick-change numbers, characters and words. Flip pages and arrange desired prices or messages. Designed to slide into the tracks of our Spiral Sign Boards, Spiral "Break-Away" Sign Holders and Ladderless Stackable Spiral Sign Boards – all sold separately. Removable and reusable.



- Wire spiral binder at the top, with an approximate 3/8" O.D.
- Pads have multiple pages with printing on both sides
- Dollar pad reads: 0, 1, 2, 3, 4, 5, 6, 7, 8, 9, \$, blank
- Cent pad reads: 0, 1, 2, 3, 4, 5, 6, 7, 8, 9, ¢, blank
- Reading pad reads: % Off, From, For, Reg, Now, And Up, After Rebate, Each, To, decimal symbol, arrow symbol, blank
- Beverage pad reads: Case, 6 Pack Cans, 6 Pack Bottles, 6 Pack, 20 Pack Cans, 20 Oz. Single, 30 Pack Cans, 24 Pack Cans, 24 Oz. Cans, 24 Oz. Bottles, 1 Liter, 2 Liter, 18 Pack Cans, 6 Pk 16.9 Oz. Bottles, 16 Oz. Cans, 12 Pack Cans, 12 Pack Bottles, Mini Cans, 12 Oz. Bottles, 15 Pack
- Other colors, sizes or messages are available – please inquire
- .015" thick PVC sheets



ITEM #	HEIGHT	WIDTH	PAD STYLE	COLOR
104200	8"	4"	Dollar	White Sheet with Black Text
104201	8"	2-1/3"	Cent	White Sheet with Black Text
104202	8"	2-1/3"	Reading	White Sheet with Black Text
104203	11-1/8"	5-1/3"	Dollar	White Sheet with Black Text
104204	11-1/8"	3"	Cent	White Sheet with Black Text
104205	11-1/8"	3"	Reading	White Sheet with Black Text
104200B	8"	4"	Dollar	Black Sheet with White Text
104201B	8"	2-1/3"	Cent	Black Sheet with White Text
104206B	8"	4"	Beverage	Black Sheet with White Text

Spiral Sign Board Brackets

Add both message signs and pricing easily and cost effectively off the tops of retail gondolas, end caps and other promotional areas with the solid support of these metal brackets. "U" shaped base clamp has an integrated thumb screw that is designed to securely mount to the tops of common 2" through 2-3/4" width gondolas or end caps. Sign boards and spiral pads sold separately. Removable and reusable with no tools required.

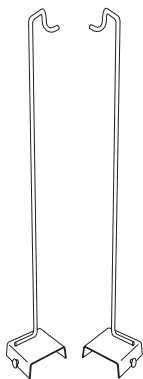

- "U" shaped base clamp is 3" wide x 2-3/4" deep
- .250" wire diameter – welded
- Assembled thumb screws are 10-24 x 1" long steel – zinc
- Brackets are white painted steel material
- Sold in complete sets only: one left bracket & one right bracket – both with assembled thumb screws
- Packaged one complete set per bag

ITEM #	MOUNTED HEIGHT	FOR USE WITH	COLOR
104215W	22"	Spiral Sign Boards	White

Spiral Dual-Channel Sign Holder

Dual channel sign holder specifically designed to hold spiral bound numeral sets or changeable sign boards from below or above. Acts as an “H” channel when combined with Spiral “Break-Away” Sign Holders (sold separately) to create unlimited spiral bound messages in a ladder style. Sign pads insert and remove easily to change prices or advertisements. Simply peel adhesive backed liner and press into place. Attaches to any clean, flat surface.

- Upper “J” adhesive backed mounting section holds pads up to 1/8" thick
- Lower “J” section holds 3/8" diameter spiral binders
- Both upper and lower sections are accessible from the side
- Custom lengths and colors available – please inquire
- Styrene material

ITEM #	OVERALL LENGTH	COLOR
108791	24"	White
108792	30"	White
108793	48"	White
108793B	48"	Black

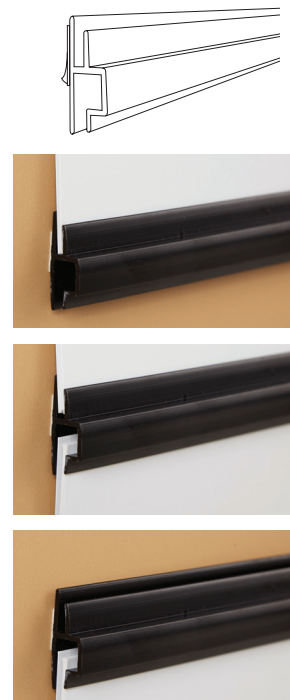

Spiral “Break-Away” Sign Holder

Dual channels that snap apart easily to form a set. Designed to hold spiral bound numerical sets or changeable board signs. Sign pads insert and remove easily to change prices. Create or design signs of any height.

- 2" pre-breakaway overall height that separates into two 1" height sections
- Upper “J” adhesive backed mounting section holds 3/8" dia. spiral binder
- Lower “J” adhesive backed mounting section holds pads up to 1/8" thick
- Both upper & lower sections are accessible from the side
- Custom lengths available
- Styrene material
- Custom colors available

ITEM #	OVERALL LENGTH	COLOR
108693	12"	White
108574	17"	White
108575	24"	White
108576	30"	White
108577	48"	White
108577B	48"	Black



Economy “C” Channel Shelf Molding

A more economical version of our “C” Channel Shelf Molding – with a thinner profile than our standard style – attaching to flat shelving fronts or clean, flat surfaces. Open face design accepts common 1-1/4" tickets, tags or signs. Simply peel adhesive liner and press into place.

- Add pricing/advertisements anywhere with little cost
- 48" length
- Custom lengths and colors available – please inquire
- HIPS material

ITEM #	HEIGHT	COLOR	TYPE OF BACKING TAPE
140940	1-1/4"	White	Transfer Tape
140940B	1-1/4"	Black	Transfer Tape



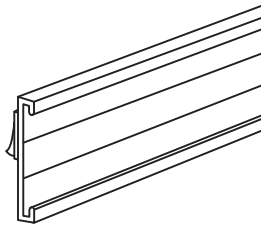

“C” Channel Shelf Molding

Otherwise known as Channel Insert Strips. Four different heights to choose from, all of which are designed to attach to shelving fronts or any clean, flat surface. Add pricing or advertisements anywhere with little cost. Open face design easily accepts common data tickets, tags or signs. Simply peel adhesive backed liner and press into place.

- 48" length
- Custom lengths and colors available
- PVC material



ITEM #	HEIGHT	COLOR	TYPE OF BACKING TAPE
108570	1-1/4"	Clear	Foam Tape
108570B	1-1/4"	Black	Foam Tape
108570W	1-1/4"	White	Foam Tape
108570T	1-1/4"	Clear	Adhesive Transfer Tape
108572	2"	Clear	Foam Tape
108572W	2"	White	Foam Tape
108690	3"	Clear	Foam Tape
108690W	3"	White	Foam Tape
108684	4"	Clear	Foam Tape
108684W	4"	White	Foam Tape

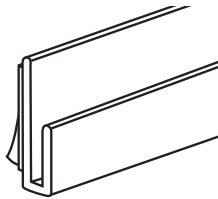

“J” Channel With Adhesive

Add advertisements anywhere with little cost. Simply peel adhesive backed liner and press into place. Attaches to any clean, flat surface. Use with “H” Channels (sold separately) to create multiple custom sign or insert holders.

- 5/8" height with 1/2" wide adhesive liner on back
- 7/32" height front lip
- 48" length
- Custom lengths available
- PVC material
- Custom colors and clear PETG also available

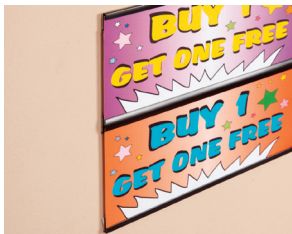
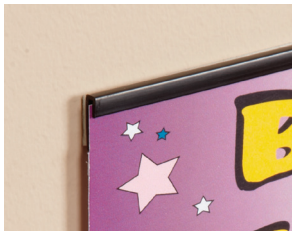

“J” Channel & “H” Channel shown together (sold separately)

ITEM #	GRIP CAPACITY	COLOR	TYPE OF BACKING TAPE
108600	up to .060"	Clear	Foam Tape
108600B	up to .060"	Black	Foam Tape
108600W	up to .060"	White	Foam Tape
108600T	up to .060"	Clear	Adhesive Transfer Tape
108601	up to .125"	Clear	Foam Tape
108601B	up to .125"	Black	Foam Tape
108601W	up to .125"	White	Foam Tape
108631	up to .250"	Clear	Foam Tape
108631B	up to .250"	Black	Foam Tape
108631W	up to .250"	White	Foam Tape

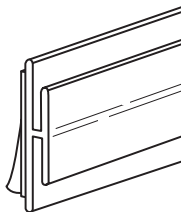

“H” Channel With Adhesive

Use with “J” Channels (sold separately) to create multiple custom sign or insert holders. Add advertisements anywhere with little cost or effort. Simply peel adhesive backed liner and press into place. Attaches to any clean, flat surface.

- 5/8" height with 1/2" wide adhesive liner on back
- 7/32" height top & bottom front lips
- 48" length
- Custom lengths available
- PVC material
- Custom colors available

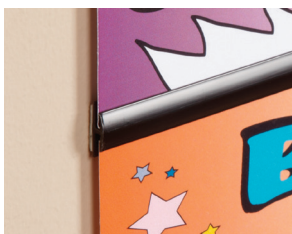

ITEM #	GRIP CAPACITY	COLOR	TYPE OF BACKING TAPE
108602	up to .060"	Clear	Foam Tape
108602B	up to .060"	Black	Foam Tape
108602W	up to .060"	White	Foam Tape

Gripper Apollo Banner Hanger With Adhesive

Simple way to add ever-changing advertisements to any clean, flat surface. Designed to quickly attach a banner to the hanger: just snap up to open, insert sign and snap down to close. Integrated soft gripper fingers hold signs firm, with two internal overlapping rails for an extra snug fit.

- 3/4" height "U" shaped square design
- Adhesive backed liner
- Integrated hinged/snap-shut gripper fin section
- Holds sign materials up to .040" thick
- Available in custom lengths, colors and/or mitered angle cuts to create frames
- PVC material
- Also available without adhesive (see page 237)

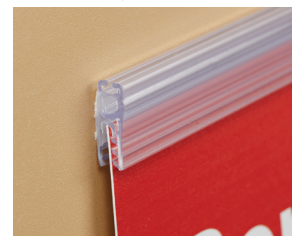
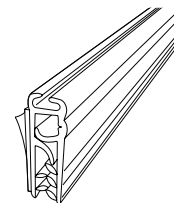

ITEM #	OVERALL LENGTH	COLOR
110724	3"	Clear
110720	22"	Clear
110721	24"	Clear
110721B	24"	Black
110722	36"	Clear
110722B	36"	Black
110723	48"	Clear
110723B	48"	Black

Front Load Plastic Sign Frame Rail

Add ever-changing advertisements anywhere with little cost. Rails can be used individually to securely mount large, poster style signs to any clean, flat surface, or order four pieces with miter cut ends to create custom sign frames – with or without backer boards.

- 1" wide with 1/2" wide adhesive backed liner
- Hinged/snap-shut front load face
- Holds material up to .060" thick
- Available in custom lengths
- Can be ordered with mitered angle cuts or mounted backer board frames
- PVC material
- Custom colors also available

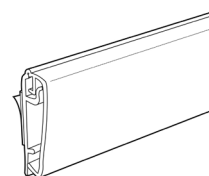

We can miter cut to fit your framing application.

ITEM #	OVERALL LENGTH	COLOR
110026	48"	Silver
110026B	48"	Black
110026C	48"	Clear

Flush Sign Holder

Sign materials slide into clip for a firm, bent-tip hold in flush position. Adheres to any clean, flat surface and is used to hold signs, lightweight displays or literature holders.

- 7/8" height with adhesive backing
- Grips up to .050" thick material
- Custom lengths available
- Super clear PETG material

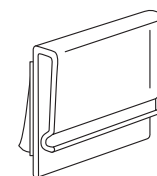

ITEM #	LENGTH	TYPE OF BACKING TAPE
108566	1"	Foam Tape
108567	3"	Foam Tape
108568	6"	Foam Tape
108569	48"	Foam Tape
108569T	48"	Adhesive Transfer Tape

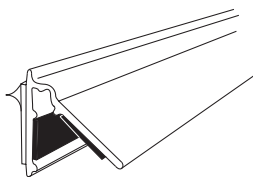

Magnetic Clamp With Adhesive – Heavy Duty

The heavy duty, hard shell version of our popular Magnetic Clamp With Adhesive offering a much firmer open and close. Secure, face-to-face hinged holding power that is perfect for hanging permanent or quick-change banners or signs. Adhesive backing adheres to clean, flat surfaces.

- 1" height front joined to 1" back via an integrated center hinge
- Adhesive backed liner
- Grips up to .030" thick material
- Both front and back sections have a built in 3/8" wide magnetic strip with matching polarity
- Can be ordered with mitered angle cuts to create custom sign frames
- White or black rigid PVC material



ITEM #	OVERALL LENGTH	COLOR
107070	3"	White
107070B	3"	Black
107071	6"	White
107071B	6"	Black
107072	48"	White
107072B	48"	Black

Sign & Literature Holders

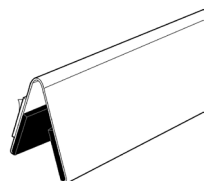

Magnetic Clamp With Adhesive

Strong open and close, face-to-face hinged holding power that is perfect for hanging permanent or quick-change thin banners or signs. Adhesive backing adheres to clean, flat surface.

- 1" height front joined to 1" back via an integrated clear center hinge
- Adhesive backed liner
- Grips up to .030" thick material
- Both front & back sections have a built-in 1/2" wide magnetic strip with matching polarity
- White or black PVC material



ITEM #	OVERALL LENGTH	COLOR
107005	3"	White
107005B	3"	Black
107006	6"	White
107006B	6"	Black
107007	48"	White
107007B	48"	Black

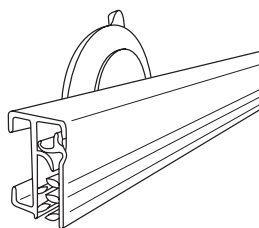

Gripper Apollo Banner Hanger With Suction Cups

Add ever-changing advertisements directly to windows or glass surfaces. The gripper is designed to quickly and easily attach a banner to the hanger: Just snap up to open, insert sign and snap down to close. Integrated soft gripper fingers hold signs firm. High quality cups with reinforcing rings for added strength and long-term holding power. Apply to clean, non-porous surface for best results.

- Apollo Banner Hanger piece is 1/2" deep x 3/4" overall height
- Comes pre-assembled with 1-3/4" diameter cups in the banner hanger
- For use in hot or cold extremes
- Not recommended for outdoor use
- Additional lengths available – please inquire
- Clear PVC material

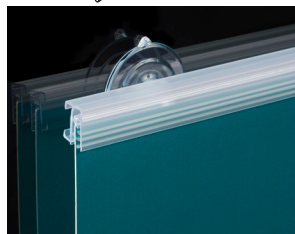

ITEM #	GRIP CAPACITY	OVERALL LENGTH	NUMBER OF SUCTION CUPS
110736	up to .040"	22"	2
110738	up to .040"	36"	3

Gripper Gondola Upright Header

Create a durable header system with little cost and maximum visibility. Gripper fins firmly hold rigid signs up to 16 inches tall in header “flush” position. The attached base is designed to fit into most standard gondola uprights. Use two sign holder ends per graphic – a left end and a right end (sold separately). Use a center sign holder to join in-line graphics that are great for eye-catching product and category branding. Removable and reusable. No assembly required. **Patented & Patent Pending.**

- End connectors are not reversible and are sold separately
- Four standard gripper lengths to choose from
- All grippers are 1-1/8" wide
- Grippers are made of clear PVC material
- Grippers are also available in black, white or others colors and/or lengths – please inquire
- Base is made of white ABS material

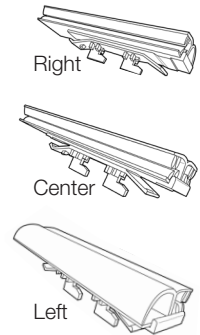

ITEM #	CONNECTOR STYLE	LENGTH	GRIP CAPACITY
106310	Left End	4"	.060" to .250"
106311	Right End	4"	.060" to .250"
106312	Center	4"	.060" to .250"
106313	Left End	8"	.060" to .250"
106314	Right End	8"	.060" to .250"
106315	Center	8"	.060" to .250"
106316	Left End	12"	.060" to .250"
106317	Right End	12"	.060" to .250"
106318	Center	12"	.060" to .250"
106319	Left End	16"	.060" to .250"
106320	Right End	16"	.060" to .250"
106321	Center	16"	.060" to .250"



Sign & Literature Holders

Gripper Warehouse Upright Header

Create a durable header system with little cost and maximum visibility. Gripper fins firmly hold rigid signs up to 16 inches tall in header “flush” position. The attached base is designed to fit into most front facing teardrop-shaped holes (not square or round) found on standard warehouse uprights. Use two sign holder ends per graphic – a left end and a right end (sold separately). Use a center sign holder to join in-line graphics that are great for eye-catching product and category branding. Removable and reusable. No assembly required. **Patented & Patent Pending.**

- End connectors are not reversible and are sold separately
- Four standard gripper lengths to choose from
- All grippers are 1-1/8" wide
- Grippers are made of clear PVC material
- Grippers are also available in black, white or others colors and/or lengths – please inquire
- Base is made of white ABS material

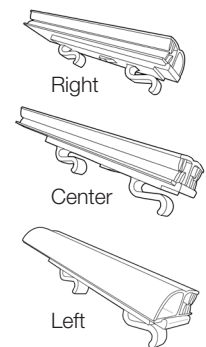

ITEM #	CONNECTOR STYLE	LENGTH	GRIP CAPACITY
106210	Left End	4"	.060" to .250"
106211	Right End	4"	.060" to .250"
106212	Center	4"	.060" to .250"
106213	Left End	8"	.060" to .250"
106214	Right End	8"	.060" to .250"
106215	Center	8"	.060" to .250"
106216	Left End	12"	.060" to .250"
106217	Right End	12"	.060" to .250"
106218	Center	12"	.060" to .250"
106219	Left End	16"	.060" to .250"
106220	Right End	16"	.060" to .250"
106221	Center	16"	.060" to .250"



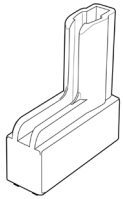

Boot System Magnetic Base

Versatile sign holder system that is capable of displaying materials up to 1/4" thick on metal surfaces when coupled with our extruded Thin Poster Channel or Heavy Duty Gripper Poster Channel (both are sold separately). Boot shaped base is removable and can be re-positioned to accommodate signs of any size or shape. Choose the proper channel for the sign thickness, insert the channel into the base and then insert the sign – it's that easy. **Warning:** Magnets should not be used near electronic equipment.

- 3/4" wide boot shaped plastic casing
- Integrated ceramic magnet base is extremely strong
- ABS material



ITEM #	LENGTH	HEIGHT	COLOR
106025	2-1/4"	2-3/4"	White
106025B	2-1/4"	2-3/4"	Black

Sign & Literature Holders

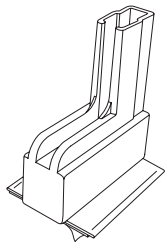

Boot System Adhesive Base

Versatile sign holder system that, when coupled with our extruded Thin Poster Channel or Heavy Duty Gripper Poster Channel (both sold separately), is capable of displaying materials up to 1/4" thick on nearly any clean, flat surface. Simply peel and stick for a secure, freestanding hold. Choose the proper channel for the sign thickness, insert the channel into the base and then insert the sign – it's that easy.

- 3/4" wide boot shaped plastic casing
- Integrated 1-3/4" wide x 2" long adhesive backed base
- ABS boot casing material and clear PVC base material



ITEM #	LENGTH	HEIGHT	COLOR
106020	2-1/4"	2-3/4"	White
106020B	2-1/4"	2-3/4"	Black

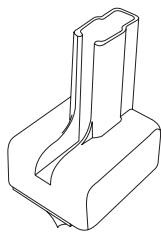

Boot System Contoured Adhesive Base

A smaller, euro style base having a more upscale elegance versus our standard boot system adhesive base. Versatile sign holder system that, when coupled with our extruded Thin Poster Channel or Heavy Duty Gripper Poster Channel (both sold separately), is capable of displaying materials up to 1/4" thick on nearly any clean, flat surface. Simply peel and stick for a secure, freestanding hold. Choose the proper channel for the sign thickness, insert the channel into the base and then insert the sign – it's that easy.

- 1-7/16" wide x 1-3/4" long boot shaped plastic base casing with adhesive
- ABS material
- Other colors also available – please inquire



ITEM #	LENGTH	HEIGHT	COLOR
106022	1-3/4"	2-1/4"	White
106022B	1-3/4"	2-1/4"	Black

Boot System Gondola Top Gripper Base

Versatile sign holder system that, when coupled with our extruded Thin Poster Channel or Heavy Duty Gripper Poster Channel (both sold separately), is capable of displaying materials up to 1/4" thick centered on top of gondolas without the need for adhesive or expensive magnets. Base has gripper fins that attach securely onto the top of standard retail gondolas. Removable and easy to relocate. Choose the proper channel for the sign thickness, insert the channel into the base and then insert the sign – it's that easy.

- 3/4" wide boot shaped plastic casing
- Integrated 3/4" height gripper legged base
- ABS boot casing material and clear PVC base material

ITEM #	LENGTH	HEIGHT	BASE CAPACITY	COLOR
106021	2-1/4"	2-3/4"	2-1/2"	White
106021B	2-1/4"	2-3/4"	2-1/2"	Black

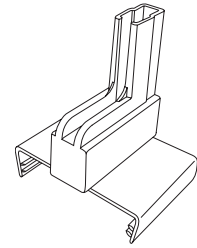

Boot System Thin Poster Channel

Use in conjunction with our Boot System Magnetic Base (sold separately) to securely hold signs from metal surfaces in either vertical or horizontal position. Even thin material is secure in this channel.

- 5/8" height
- Custom lengths available
- Clear PVC material
- Custom colors available

ITEM #	LENGTH	GRIP CAPACITY	COLOR
108507	12"	up to 1/8"	Clear
108508	18"	up to 1/8"	Clear
140707	24"	up to 1/8"	Clear

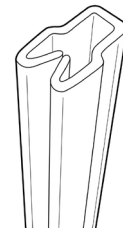

Boot System Heavy Duty Gripper Poster Channel

Use in conjunction with our Boot System Magnetic Base (sold separately) to securely hold thicker signs from metal surfaces in either vertical or horizontal position. Gripper fins offer heavy duty holding power for thicker signs in this channel.

- 5/8" height
- Custom lengths available
- Clear PVC material
- Custom colors available

ITEM #	LENGTH	GRIP CAPACITY	COLOR
108513	12"	1/8" to 1/4"	Clear
108514	18"	1/8" to 1/4"	Clear
140708	24"	1/8" to 1/4"	Clear
140709	36"	1/8" to 1/4"	Clear

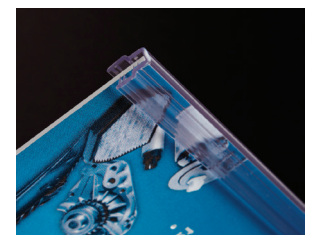
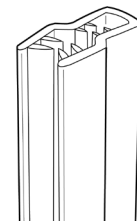

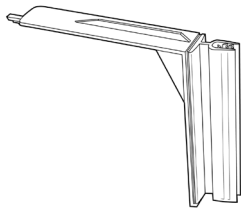

Shelf-Top Gripper Sign Holder

Gripper fins hold signs firmly in vertical (flag) position. Use two or more holders from shelf to shelf for larger signs. Hinged style option is great for mounting signs in high traffic areas – flexible hinge swings and returns to original position when bumped. The base is designed to fit into most perforated shelves. Removable and reusable. No assembly required. **Patented & Patent Pending.**

- Grippers are 3" long x 3/4" wide base
- Small capacity grippers have 3/4" height; large capacity grippers have 1" height
- Grippers are made of clear PVC material
- Base is made of ABS material



ITEM #	STYLE	GRIP CAPACITY	COLOR
106401	With Hinge	up to .100"	Beige
106401B	With Hinge	up to .100"	Black
106402	With Hinge	.100" to .250"	Beige
106402B	With Hinge	.100" to .250"	Black
106403	No Hinge	up to .100"	Beige
106403B	No Hinge	up to .100"	Black
106404	No Hinge	.100" to .250"	Beige
106404B	No Hinge	.100" to .250"	Black

Sign & Literature Holders

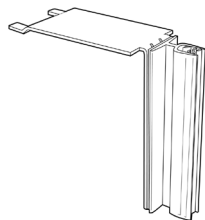

Shelf-Top Gripper Sign Holder – Metal

Gripper fins hold signs firmly in vertical (flag) position. Use two or more holders from shelf to shelf for larger signs. Hinged style option is great for mounting signs in high traffic areas – flexible hinge swings and returns to original position when bumped. The metal base is designed for extra strength/durability and fits into most perforated shelves. Removable and reusable. No assembly required. **Patented & Patent Pending.**

- Grippers are 3" long x 3/4" wide base
- Small capacity grippers have 3/4" height; large capacity grippers have 1" height
- Grippers are made of clear PVC material
- Base is made of beige painted steel material



ITEM #	STYLE	GRIP CAPACITY
106801	With Hinge	up to .100"
106802	With Hinge	.100" to .250"
106803	No Hinge	up to .100"
106804	No Hinge	.100" to .250"

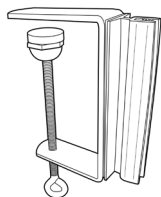

“C” Clamp Gripper Aisle Sign Holder

Gripper fins hold signs firmly in vertical (flag) position. Universal “C” clamp design can be used on square edges of shelves, fixtures or just about anywhere throughout the store. Use two or more holders from shelf to shelf for larger signs. Hinged style option is great for mounting signs in high traffic areas – flexible hinge swings and returns to original position when bumped. Removable and reusable. Pre-assembled black plastic crutch-tipped screw eye design. **Patented & Patent Pending.** No assembly required. Unlike our competition, our design allows the sign to be aligned closer to the shelf edge, providing a cleaner look and less chance of being bumped.

- Fits shelves or other fixtures up to 2-1/2" thick
- 3" height x 3/4" wide x 2" deep “C” clamp size with two 3/16" dia. mounting holes
- Grippers are 3" long x 3/4" wide base
- Small capacity grippers have 3/4" height; large capacity grippers have 1" height
- Grippers are made of clear PVC material
- Base is made of steel with zinc plate



ITEM #	STYLE	GRIP CAPACITY
106931	With Hinge	up to .100"
106932	With Hinge	.100" to .250"
106933	No Hinge	up to .100"
106934	No Hinge	.100" to .250"

Channel Mount Gripper Sign Holder

Gripper fins hold signs firmly in vertical (flag) position. Use two or more holders from shelf to shelf for larger signs. Hinged style option is great for mounting signs in high traffic areas – flexible hinge swings and returns to original position when bumped. The base is designed to fit into most standard 1-1/4" shelf price channels with the turn of an attached Phillips/slotted combo pan head screw. Removable and reusable. No assembly required. **Patented & Patent Pending.**

- Grippers are 3" long x 3/4" wide base
- Small capacity grippers have 3/4" height; large capacity grippers have 1" height
- Grippers are made of clear PVC material
- Also available with thumb screw (please inquire)
- Base is made of beige ABS material

ITEM #	STYLE	GRIP CAPACITY
106601	With Hinge	up to .100"
106602	With Hinge	.100" to .250"
106603	No Hinge	up to .100"
106604	No Hinge	.100" to .250"

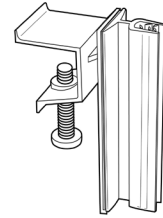

Channel Mount Gripper Sign Holder – Metal

Gripper fins hold signs firmly in vertical (flag) position. Use two or more holders from shelf to shelf for larger signs. Hinged style is great for mounting signs in high-traffic areas - flexible hinge swings and returns to original position when bumped. The durable metal base fits into standard 1-1/4" shelf price channels, tightening using an included screw. Removable and reusable.

- Grippers are 3" long x 3/4" wide base
- Small capacity grippers have 3/4" height; large capacity grippers have 1" height
- Grippers are made of clear PVC material
- Base is made of beige painted steel material

ITEM #	SCREW TYPE	STYLE	GRIP CAPACITY
106621	Thumb Screw	With Hinge	up to .100"
106622	Thumb Screw	With Hinge	.100" to .250"
106623	Thumb Screw	No Hinge	up to .100"
106624	Thumb Screw	No Hinge	.100" to .250"
116621	Phillips Pan Head Screw	With Hinge	up to .100"
116622	Phillips Pan Head Screw	With Hinge	.100" to .250"
116623	Phillips Pan Head Screw	No Hinge	up to .100"
116624	Phillips Pan Head Screw	No Hinge	.100" to .250"

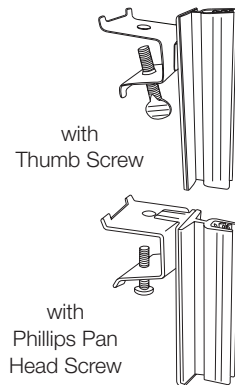

Channel Mount Swivel Gripper

Durable base mounts into standard "C" channels using an integrated screw. Gripper fins hold signs firmly in vertical (flag) position. Gripper can be angled upward or downward for optimal viewing. The base's swivel-spring feature is great for mounting signs in high-traffic areas - sign returns to original position when bumped. Removable and reusable.

- 1-3/4" wide steel base mounts securely into standard price channels
- Device extends approximately 2" out from shelf, not counting the attached gripper
- Grippers are 3" long x 3/4" wide, made of clear PVC material
- Base is zinc-plated steel and durable plastic

ITEM #	GRIP CAPACITY	COLOR
150903B	up to .100"	Black
150904B	.100" to .250"	Black

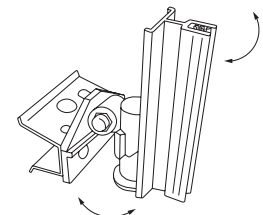

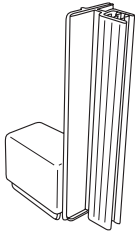

Magnetic Shelf-Top Gripper Sign Holder

Gripper fins hold signs firmly in vertical (flag) position. Great for mounting signs directly off the tops of metal shelves or gondolas without the need for adhesive. Use two holders facing each other to hold blade signs directly off the sides or tops of gondolas either vertically or horizontally. Hinged style option is great for mounting signs in high traffic areas - flexible hinge swings and returns to original position when bumped. Removable and reusable. No assembly required. **Patented & Patent Pending.**

Warning: Magnets should not be used near electronic equipment.

- Grippers are 3" long x 3/4" wide base
- Small capacity grippers have 3/4" height; large capacity grippers have 1" height
- Grippers are made of clear PVC material
- Base is made of white ABS material



ITEM #	STYLE	GRIP CAPACITY
106781	With Hinge	up to .100"
106782	With Hinge	.100" to .250"
106783	No Hinge	up to .100"
106784	No Hinge	.100" to .250"

Sign & Literature Holders

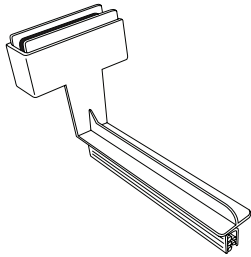

Magnetic Under-Shelf Gripper Sign Holder – L-Style

Gripper fins hold signs firmly in horizontal position. The magnetic base mounts underneath the shelf and is designed to add shelf edge signs from below – thus not interfering with product on shelves. Integrated, heavy duty magnet attaches to any metal surface, including the underside of perforated shelves. Removable and reusable. No assembly required. Optional flexible hinge on sign gripper swings and returns to original position when bumped in high-traffic areas. **Patent Pending.**

Warning: Magnets should not be used near electronic equipment.

- Grippers are 4" long x 3/4" wide base
- Small capacity grippers have 3/4" height; large capacity grippers have 1" height
- Grippers are made of clear PVC material
- Base is made of ABS material



ITEM #	STYLE	GRIP CAPACITY	COLOR
106971	With Hinge	up to .100"	Beige
NEW 106971B	With Hinge	up to .100"	Black
106972	With Hinge	.100" to .250"	Beige
NEW 106972B	With Hinge	.100" to .250"	Black
106973	No Hinge	up to .100"	Beige
NEW 106973B	No Hinge	up to .100"	Black
106974	No Hinge	.100" to .250"	Beige
NEW 106974B	No Hinge	.100" to .250"	Black

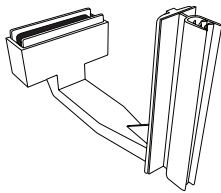

Magnetic Under-Shelf Gripper Sign Holder

Gripper fins hold signs firmly in vertical (flag) position. Use two or more holders from shelf to shelf for larger signs. Hinged style option is great for mounting signs in high traffic areas – flexible hinge swings and returns to original position when bumped. The magnetic base mounts underneath the shelf and is designed to add shelf edge signs from below – thus not interfering with product on shelves. Integrated, heavy duty magnet attaches to any metal surface, including the underside of perforated shelves. Removable and reusable. No assembly required. Unlike our competition, our design allows the sign to be aligned closer to the shelf edge, providing a cleaner look and less chance of being bumped. **Patented. Warning:** Magnets should not be used near electronic equipment.

- Grippers are 3" long x 3/4" wide base
- Small capacity grippers have 3/4" height; large capacity grippers have 1" height
- Grippers are made of clear PVC material
- Base is made of ABS material



ITEM #	STYLE	GRIP CAPACITY	COLOR
106961	With Hinge	up to .100"	Beige
106961B	With Hinge	up to .100"	Black
106962	With Hinge	.100" to .250"	Beige
106962B	With Hinge	.100" to .250"	Black
106963	No Hinge	up to .100"	Beige
106963B	No Hinge	up to .100"	Black
106964	No Hinge	.100" to .250"	Beige
106964B	No Hinge	.100" to .250"	Black

Magnetic Non-Tip Under-Shelf Gripper Sign Holder

Integrated non-tip wedge feature that prevents the base from tipping. Gripper fins hold signs firmly in vertical (flag) position. Use two or more holders for larger signs. Hinged style option is great for mounting signs in high traffic areas – flexible hinge swings & returns to original position when bumped. The magnetic, non-tip base mounts underneath the shelf and is designed to add shelf edge signs from below – thus not interfering with product on shelves. Integrated, heavy duty magnet attaches to any metal surface, including the underside of perforated shelves. Removable and reusable. No assembly required. Unlike our competition, our design allows the sign to be aligned closer to the shelf edge, providing a cleaner look and less chance of being bumped. **Patented. Warning:** Magnets should not be used near electronic equipment.

- Base has an integrated non-tip wedge feature
- Grippers are 3" long x 3/4" wide base
- Small capacity grippers have 3/4" height; large capacity grippers have 1" height
- Grippers are made of clear PVC material
- Base is made of ABS material

ITEM #	STYLE	GRIP CAPACITY	COLOR
106981	With Hinge	up to .100"	Beige
106981B	With Hinge	up to .100"	Black
106982	With Hinge	.100" to .250"	Beige
106982B	With Hinge	.100" to .250"	Black
106983	No Hinge	up to .100"	Beige
106983B	No Hinge	up to .100"	Black
106984	No Hinge	.100" to .250"	Beige
106984B	No Hinge	.100" to .250"	Black

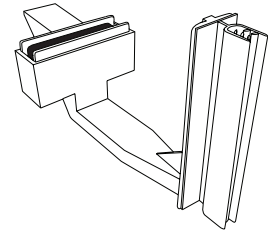

Under-Shelf Spring-Mount Gripper Sign Holder

Gripper fins hold signs firmly in vertical (flag) position. Use two or more holders from shelf to shelf for larger signs. Hinged style option is great for mounting signs in high traffic areas – flexible hinge swings and returns to original position when bumped. The base mounts underneath the shelf and is designed to add shelf edge signs from below – thus not interfering with product on shelves. Spring steel leg tabs clip securely into most perforated shelves. Removable and reusable. No assembly required. **Patented & Patent Pending.**

- Grippers are 3" long x 3/4" wide base
- Small capacity grippers have 3/4" height; large capacity grippers have 1" height
- Grippers are made of clear PVC material
- Base is made of beige painted spring steel material

ITEM #	STYLE	GRIP CAPACITY
106701	With Hinge	up to .100"
106702	With Hinge	.100" to .250"
106703	No Hinge	up to .100"
106704	No Hinge	.100" to .250"

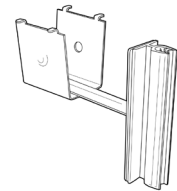

Under-Shelf Screw-Mount Gripper Sign Holder

Gripper fins hold signs firmly in vertical (flag) position. Use two or more holders from shelf to shelf for larger signs. Hinged style option is great for mounting signs in high traffic areas – flexible hinge swings and returns to original position when bumped. The base locks underneath the shelf with an integrated threaded eye screw and is designed to add shelf edge signs from below – thus not interfering with product on shelves. Spring steel leg tabs clip directly into most perforated shelves. Removable and reusable. No assembly required. **Patented & Patent Pending.**

- Grippers are 3" long x 3/4" wide base
- Small capacity grippers have 3/4" height; large capacity grippers have 1" height
- Grippers are made of clear PVC material
- Base is made of beige painted spring steel material
- Assembled eye screw is 10-24 x 2-1/4" overall length, zinc plated steel

ITEM #	STYLE	GRIP CAPACITY
106911	With Hinge	up to .100"
106912	With Hinge	.100" to .250"
106913	No Hinge	up to .100"
106914	No Hinge	.100" to .250"

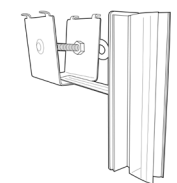

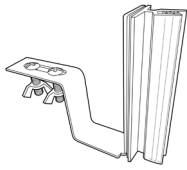

Under-Shelf Hardware-Mount Gripper Sign Holder

Secure way to add signs at the shelf edge. Gripper fins hold signs firmly in vertical (flag) position. Use two or more holders from shelf to shelf for larger signs. Hinged style option is great for mounting signs in high traffic areas – flexible hinge swings and returns to original position when bumped. The metal base is designed for extra strength/durability and fits the underside of most perforated shelves using included hardware. Removable and reusable. No assembly required. **Patented & Patent Pending.**

- Under-shelf mounting ensures no product interference
- Grippers are 3" long x 3/4" wide base
- Small capacity grippers have 3/4" height; large capacity grippers have 1" height
- Grippers are made of clear PVC material
- Base is made of beige painted spring steel material
- Assembled wing nuts and screws are zinc plated steel



ITEM #	STYLE	GRIP CAPACITY
106941	With Hinge	up to .100"
106942	With Hinge	.100" to .250"
106943	No Hinge	up to .100"
106944	No Hinge	.100" to .250"

Sign & Literature Holders

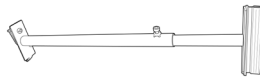

Telescopic Gripper Aisle Sign Holder – Gondola

Gripper fins hold signs firmly in vertical (flag) position. Use two holders to support larger signs. Hinged style option is great for mounting signs in high traffic areas – flexible hinge swings and returns to original position when bumped. The base is designed to securely fit into most standard gondola uprights. Removable and reusable. Assembled telescoping arm easily adjusts from 13" to 21" long in 1" increments. No assembly required. **Patented & Patent Pending.**

- Grippers are 3" long x 3/4" wide base
- Small capacity grippers have 3/4" height; large capacity grippers have 1" height
- Grippers are made of clear PVC material
- Base is made of painted steel material, and comes assembled with zinc plated flip nut inserts



ITEM #	STYLE	GRIP CAPACITY	COLOR
106901	With Hinge	up to .100"	Beige
106901B	With Hinge	up to .100"	Black
106902	With Hinge	.100" to .250"	Beige
106902B	With Hinge	.100" to .250"	Black
106903	No Hinge	up to .100"	Beige
106903B	No Hinge	up to .100"	Black
106904	No Hinge	.100" to .250"	Beige
106904B	No Hinge	.100" to .250"	Black

Tool-Free Telescopic Gripper Aisle Sign Holder – Gondola

Gripper fins hold signs firmly in vertical (flag) position. Use two holders to support larger signs. Hinged style option is great for mounting signs in high traffic areas – flexible hinge swings and returns to original position when bumped. The base is designed to securely fit into most standard gondola uprights without the need for a screwdriver. Removable and reusable. Assembled telescoping arm easily adjusts from 13" to 21" long in 1" increments. No assembly required. **Patent Pending.**

- Tool-free style that can be installed without a screwdriver
- Grippers are 3" long x 3/4" wide base
- Small capacity grippers have 3/4" height; large capacity grippers have 1" height
- Grippers are made of clear PVC material
- Base is made of beige painted steel material



ITEM #	STYLE	GRIP CAPACITY
106991	With Hinge	up to .100"
106992	With Hinge	.100" to .250"
106993	No Hinge	up to .100"
106994	No Hinge	.100" to .250"

Telescopic Double-Hook Aisle Sign Holder – Gondola

Hold aisle signs securely in flag position while capturing customer attention. Adjustable double-wire hooks fit a wide range of hole placement widths of up to 10 inches apart. The base is designed to lock into most standard slotted gondola uprights. Assembled telescopic arm easily adjusts from 13" to 21" in 1" increments. Removable and reusable.

- Includes a rubber tip safety end cap – beige
- 12 gauge (.105") hook wire diameter
- 3/8" maximum sign material thickness
- Minimum recommended sign hole size is 1/8"
- Beige painted steel material with assembled zinc-plated flip nut insert
- Other colors available – please inquire

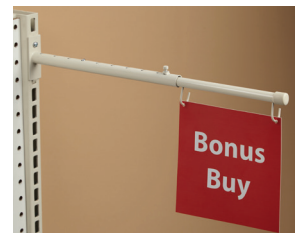

ITEM #	HOLE PLACEMENT	HOOK OPENINGS	COLOR
106905	1" to 10" Width	9/16"	Beige

Telescopic Gripper Aisle Sign Holder – Pegboard

Gripper fins hold signs firmly in vertical (flag) position. Use two holders to support larger signs. Hinged style option is great for mounting signs in high traffic areas – flexible hinge swings and returns to original position when bumped. The 1" on center base prongs are designed to securely fit into most standard pegboard holes. Removable and reusable. Assembled telescoping arm easily adjusts from 13" to 21" long in 1" increments. No assembly required. **Patented & Patent Pending.**

- Grippers are 3" long x 3/4" wide base
- Small capacity grippers have 3/4" height; large capacity grippers have 1" height
- Grippers are made of clear PVC material
- Base is made of painted steel material

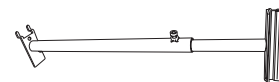

ITEM #	STYLE	GRIP CAPACITY	COLOR
106921	With Hinge	up to .100"	Beige
106921B	With Hinge	up to .100"	Black
106922	With Hinge	.100" to .250"	Beige
106922B	With Hinge	.100" to .250"	Black
106923	No Hinge	up to .100"	Beige
106923B	No Hinge	up to .100"	Black
106924	No Hinge	.100" to .250"	Beige
106924B	No Hinge	.100" to .250"	Black

Sign & Literature Holders

Telescopic Double-Hook Aisle Sign Holder – Pegboard/Slatwall

Hold aisle signs securely in flag position while capturing customer attention. Adjustable double-wire hooks fit a wide range of hole placement widths of up to 10 inches apart. The 1" on center base prongs are designed to fit into most standard pegboard holes. Unlike our competition, the base is also designed to fit into most standard slatwall grooves. Assembled telescopic arm easily adjusts from 13" to 21" in 1" increments. Removable and reusable.

- Includes a rubber tip safety end cap – beige
- 12 gauge (.105") hook wire diameter
- 3/8" maximum sign material thickness
- Minimum recommended sign hole size is 1/8"
- Beige painted steel material
- Other colors available – please inquire

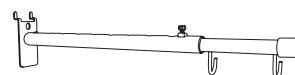

ITEM #	HOLE PLACEMENT	HOOK OPENINGS	COLOR
106906	1" to 10" Width	9/16"	Beige

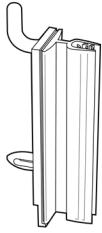

Pegboard Gripper Sign Holder

Gripper fins hold signs firmly in vertical (flag) position. Use two or more holders for larger signs. Hinged style option is great for mounting signs in high traffic areas – flexible hinge swings and returns to original position when bumped. The base is designed to fit into most standard pegboard. Removable and reusable. No assembly required. **Patented & Patent Pending.**

- Grippers are 3" long x 3/4" wide base
- Small capacity grippers have 3/4" height; large capacity grippers have 1" height
- Grippers are made of clear PVC material
- Base is made of white ABS material

ITEM #	STYLE	GRIP CAPACITY
106501	With Hinge	up to .100"
106502	With Hinge	.100" to .250"
106503	No Hinge	up to .100"
106504	No Hinge	.100" to .250"

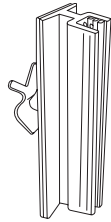

Slatwall Gripper Sign Holder

Base fits into standard slatwall. Gripper fins hold signs firmly in vertical (flag) position. Use two or more holders for large blade signs. Hinged style is great for mounting signs in high-traffic areas - flexible hinge swings and returns to original position when bumped.

- Comes unassembled for easy installation into standard slatwall
- Grippers are 3" long x 3/4" wide base
- Small capacity grippers have 3/4" height; large capacity grippers have 1" height
- Grippers are made of clear PVC
- Base is natural polypropylene

ITEM #	STYLE	GRIP CAPACITY
106461	With Hinge	up to .100"
106462	With Hinge	.100" to .250"
106463	No Hinge	up to .100"
106464	No Hinge	.100" to .250"

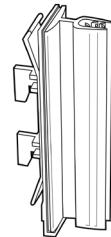

Gondola Upright Gripper Sign Holder

Gripper fins hold signs firmly in vertical (flag) position. Use two or more holders for larger signs. Hinged style option is great for mounting signs in high traffic areas – flexible hinge swings and returns to original position when bumped. The base is designed to fit into most standard gondola uprights. Removable and reusable. No assembly required. **Patented & Patent Pending.**

- Grippers are 3" long x 3/4" wide base
- Small capacity grippers have 3/4" height; large capacity grippers have 1" height
- Grippers are made of clear PVC material
- Base is made of white ABS material

ITEM #	STYLE	GRIP CAPACITY
106301	With Hinge	up to .100"
106302	With Hinge	.100" to .250"
106303	No Hinge	up to .100"
106304	No Hinge	.100" to .250"

NEW

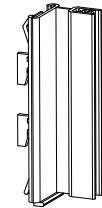

Gondola Upright "Offset" Gripper Sign Holder

A variation of our traditional Gondola Upright Gripper Sign Holder. Here, the grippers are "offset" to one side, not centered. Ideal for end cap displays. Gripper fins hold signs in vertical (flag) position. Use two or more holders for larger signs. Sold unassembled.

- Base fits most standard gondola uprights
- Grippers are 3" long x 3/4" wide base
- Grippers are clear PVC material
- Base is white ABS material
- Gripper portion can be used on other Kinter bases – please inquire

ITEM #	STYLE	GRIP CAPACITY
106306	With Hinge	up to .100"
106309	With Hinge	.100 to .250"

Warehouse Upright Gripper Sign Holder

Gripper fins hold signs firmly in vertical (flag) position. Use two or more holders for larger signs. Hinged style option is great for mounting signs in high traffic areas – flexible hinge swings and returns to original position when bumped. The base is designed to fit into most teardrop shaped holes (not square or round holes) found on standard warehouse uprights. Removable and reusable. No assembly required. **Patented & Patent Pending.**

- Grippers are 3" long x 3/4" wide base
- Small capacity grippers have 3/4" height; large capacity grippers have 1" height
- Grippers are made of clear PVC material
- Base is made of white ABS material

ITEM #	STYLE	GRIP CAPACITY
106201	With Hinge	up to .100"
106202	With Hinge	.100" to .250"
106203	No Hinge	up to .100"
106204	No Hinge	.100" to .250"

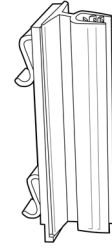

Warehouse Upright Sign Holder For Square Holes

Attaches into most warehouse uprights that have square holes, and can be repositioned easily. Gripper fins hold signs firmly in vertical (flag) position. Hinged style option is great for mounting signs in high-traffic areas – flexible hinge swings and returns to original position when bumped. Use two or more holders to support large blade signs.

- Adds aisle or promotional signs to square-hole warehouse uprights
- Grippers are 3" long x 3/4" wide base
- Small capacity grippers have 3/4" height; large capacity grippers have 1" height
- Grippers are made of clear PVC material
- Base is made of white ABS material

ITEM #	STYLE	GRIP CAPACITY
106231	With Hinge	up to .100"
106232	With Hinge	.100" to .250"
106233	No Hinge	up to .100"
106234	No Hinge	.100" to .250"

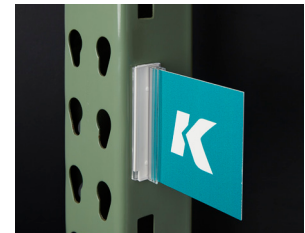

Warehouse Upright Gripper Sign Holder – Canadian

Gripper fins hold signs firmly in vertical (flag) position. Use two or more holders for larger signs. Hinged style option is great for mounting signs in high traffic areas – flexible hinge swings and returns to original position when bumped. The base is designed to fit into most rectangular and teardrop shaped holes (not square or round holes) that are 3" on center. 3" on center holes are common in Canada and not in other North American regions where 2" on center holes are predominant. Removable and reusable. **Patented & Patent Pending:** Unlike our competition, the gripper is permanently attached to the base adapter; thus, there is no chance of dislodgement and no assembly is required.

- Grippers are 4" long x 3/4" wide base
- Small capacity grippers have 3/4" height; large capacity grippers have 1" height
- Grippers are made of clear PVC material
- Base is made of white ABS material

ITEM #	STYLE	GRIP CAPACITY
106881	With Hinge	up to .100"
106882	With Hinge	.100" to .250"
106883	No Hinge	up to .100"
106884	No Hinge	.100" to .250"

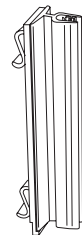

NEW

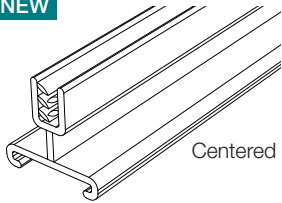

Slide-On Gripper Sign Holders

Compatible with numerous Kinter brackets to create your custom sign holder.

- Slide-on (wraparound) legs make parts removable and reusable
- Available with or without hinge (Hinge allows signs to flex when bumped)
- Available with centered gripper or offset gripper
- Custom lengths available – please inquire
- Clear PVC material

ITEM #	LENGTH	STYLE	GRIP CAPACITY	POSITION
116101	3"	With Hinge	up to .100"	Centered
116102	3"	With Hinge	.100" to .250"	Centered
116103	3"	No Hinge	up to .100"	Centered
116104	3"	No Hinge	.100" to .250"	Centered
116106	3"	With Hinge	up to .100"	Offset Style
116109	3"	With Hinge	.100" to .250"	Offset Style

Sign & Literature Holders

NEW

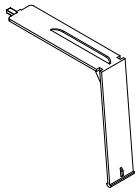

Shelf-Top Bracket

Fits most perforated shelves.

- Face plate measures 3" height x 3/4" wide
- Compatible with Kinter's slide-on grippers and other adhesive sign holders
- ABS material

ITEM #	COLOR
116400	Beige
116400B	Black

NEW

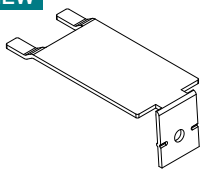

Metal Shelf-Top Bracket

Fits most standard perforated shelves.

- Face plate measures 15/16" height x 3/4" wide, with a 3/16" diameter hole
- Compatible with Kinter's slide-on grippers and other adhesive sign holders
- Steel material

ITEM #	COLOR
116800	Beige

“C” Clamp Bracket

Attaches to most shelves or table edges using turn screw with rubber stopper (included).

- Fits shelves or other fixtures up to 2-1/2" thick
- 3" height x 3/4" wide x 2" deep “C” clamp size with two 3/16" dia. mounting holes
- Steel material

ITEM #	FINISH
106930	Zinc plated

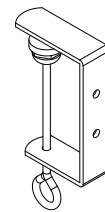

NEW



Channel Mount Bracket

Fits most 1-1/4" height shelf channels, with combo machine screw included.

- Face plate measures 3" height x 3/4" wide
- Compatible with Kinter's slide-on grippers and other adhesive sign holders
- ABS material

ITEM #	COLOR
116600	Beige

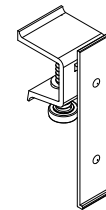

NEW



Magnetic Under-Shelf Bracket – L-Style

Fits securely underneath metal shelves with heavy-duty magnet.

- Face plate measures 4" length x 3/4" wide
- Compatible with Kinter's slide-on grippers and other adhesive sign holders
- ABS material

ITEM #	COLOR
116970	Beige
116970B	Black

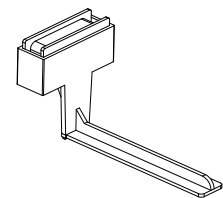

NEW



NEW

Magnetic Under-Shelf Bracket

Fits securely underneath metal shelves with heavy-duty magnet.

- Face plate measures 3" height x 3/4" wide
- Compatible with Kinter's slide-on grippers and other adhesive sign holders
- ABS material

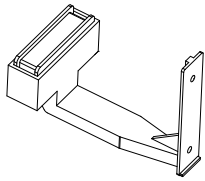

ITEM #	COLOR
116960	Beige
116960B	Black

Sign & Literature Holders

NEW

Under-Shelf Bracket

Fits most perforated shelves, with two mounting styles to choose from.

- Face plate measures 1-9/16" height x 3/4" wide
- Compatible with Kinter's slide-on grippers and other adhesive sign holders
- Steel material

#116700

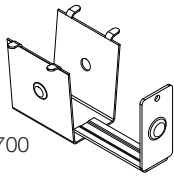

#116910

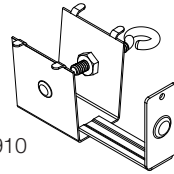

ITEM #	STYLE	COLOR
116700	Spring-Mount	Beige
116910	Screw-Mount	Beige

NEW

Under-Shelf Hardware-Mount Bracket

Fits most perforated shelves using wing nuts & bolts (included).

- Face plate measures 1-3/4" height x 3/4" wide, with two 1/4" diameter mounting holes that are 1-1/4" on center
- Compatible with Kinter's slide-on grippers and other adhesive sign holders
- Steel material

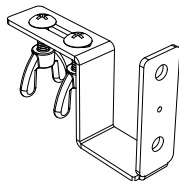

ITEM #	COLOR
116940	Beige

Metal Telescopic Bracket

NEW

Compatible with Kinter's slide-on grippers and other adhesive sign holders.

- Telescoping arm adjusts from 13" to 21" long in 1" increments
- Face plate measures 3" height x 3/4" wide, with one 3/16" diameter hole
- Steel material

ITEM #	FOR USE ON	COLOR
116900	Gondola Uprights (w/ Zinc-Plated Flip Nut Insert)	Beige
116900B	Gondola Uprights (w/ Zinc-Plated Flip Nut Insert)	Black
116990	Gondola Uprights (Tool-Free Style – No Flip Nut)	Beige
116920	Pegboard	Beige
116920B	Pegboard	Black

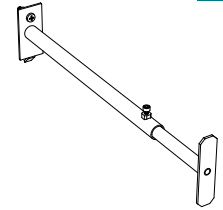

#116900

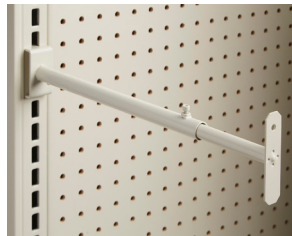

#116990

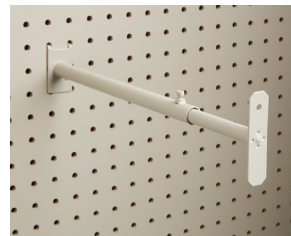
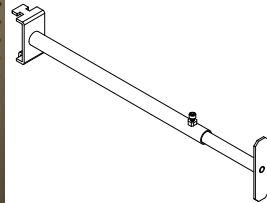

#116920

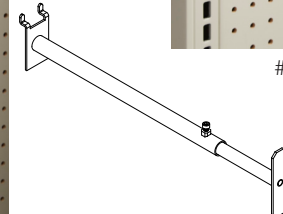

Pegboard Bracket

NEW

Fits into most standard pegboard.

- Face plate measures 2-5/8" height x 3/4" wide
- Compatible with Kinter's slide-on grippers and other adhesive sign holders
- ABS material

ITEM #	COLOR
116500	White



Slatwall Bracket

NEW

Fits most standard slatwall.

- Face plate measures 1-5/8" height x 3/4" wide
- Compatible with Kinter's slide-on grippers and other adhesive sign holders
- Polypropylene material

ITEM #	COLOR
116460	Translucent

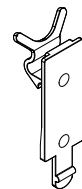

NEW

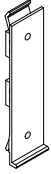

Gondola Upright Bracket

Fits securely into most standard gondola uprights.

- Face plate measures 2-3/4" height x 3/4" wide
- Compatible with Kinter's slide-on grippers and other adhesive sign holders
- ABS material



ITEM #	COLOR
116300	White

Sign & Literature Holders

NEW



Warehouse Upright Bracket

Fits securely into most teardrop-shaped holes on standard warehouse uprights (not square or round holes).

- Face plate measures 3" height x 3/4" wide
- Compatible with Kinter's slide-on grippers and other adhesive sign holders
- ABS material



ITEM #	COLOR
116200	White

NEW



Warehouse Upright Bracket For Square Holes

Fits securely into most square-hole warehouse uprights.

- Face plate measures 3" height x 3/4" wide
- Compatible with Kinter's slide-on grippers and other adhesive sign holders
- ABS material



ITEM #	COLOR
116230	White

K-Ads® Billboard Suction Cup Sign Holder

K-Ads Billboards are the affordable way to create new revenue or advertise your product right on the cooler door. Cleans up cooler door clutter to better connect with shoppers. Be the only image in the customer's mind when they reach inside the cooler. Integrated high-quality **USA made** suction cups with unique reinforcing rings for added strength and long-term holding power. Mount to clean, non-porous surface for best results in either vertical (portrait) or horizontal (landscape) orientation. **Patented.**

- Firmly installs in seconds with no tools required
- Overall frame size is 4-5/8" wide x either 7-1/4" or 14-1/4" overall length
- For use in cold or hot extremes
- Once the K-Ads Billboard frame is in place, ads can be inserted and changed with ease
- Graphic capacity is .025" maximum thickness card stock
- Comes fully assembled with inserted plastic protective ad cover
- 3-1/4" O.D. suction cups are clear UV resistant PVC material – won't yellow or become brittle
- Top and bottom caps are made of high-impact black plastic
- Available in either black PVC or black anodized aluminum material
- Other sizes and colors available – please inquire
- Sold in full boxes only at 10 pieces per box

ITEM #	SIGN WIDTH	SIGN LENGTH	MATERIAL	COLOR
107254	4-1/2"	7"	Plastic	Black
107251	4-1/2"	14"	Plastic	Black
107253	4-1/2"	7"	Aluminum	Black
107250	4-1/2"	14"	Aluminum	Black



Can be mounted vertically or horizontally

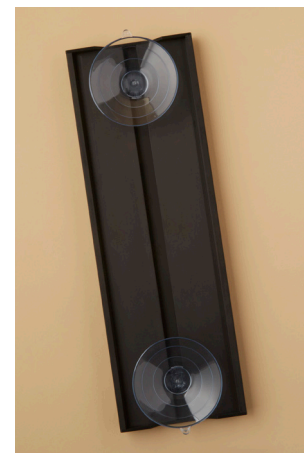
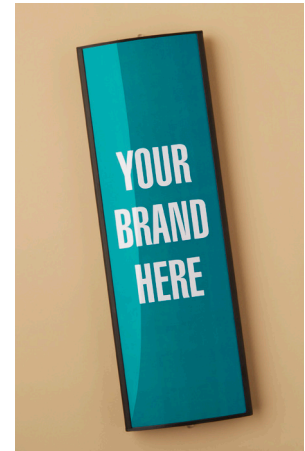
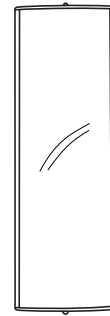

Sign & Literature Holders

K-ADS®
BILLBOARD
 BY KINTER



For more information, go to kads.com

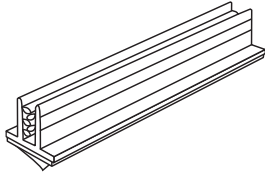

Gripper Sign Holder

Gripper fins hold sign securely in vertical (flag) or horizontal position. Adhesive bottom adheres to clean, flat surfaces. Use wider base for more stability.

- 1/2" height
- Holds material up to .080" thick
- Custom lengths available
- Parts listed below are stocked with either standard "permanent" or optional "removable" adhesive
- Available without adhesive (please inquire) or with a magnet (see pages 116-117).
- Clear PVC material

ITEM #	LENGTH	BASE WIDTH	BASE TYPE	ADHESIVE STYLE	GRIP CAPACITY
108523	1"	1/2"	Narrow	Standard "Permanent"	up to .080"
108523R	1"	1/2"	Narrow	Optional "Removable"	up to .080"
108525	1"	1"	Wide	Standard "Permanent"	up to .080"
108525R	1"	1"	Wide	Optional "Removable"	up to .080"
108524	3"	1/2"	Narrow	Standard "Permanent"	up to .080"
108524R	3"	1/2"	Narrow	Optional "Removable"	up to .080"
108526	3"	1"	Wide	Standard "Permanent"	up to .080"
108526R	3"	1"	Wide	Optional "Removable"	up to .080"
108535	6"	1"	Wide	Standard "Permanent"	up to .080"

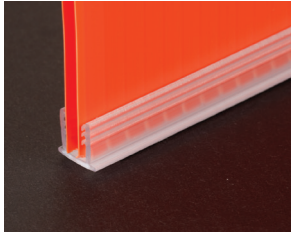
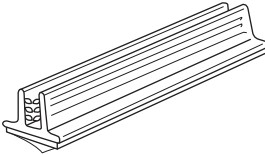

Heavy Duty Gripper Sign Holder – Narrow

Heavy duty style holds thicker sign and display material than standard gripper sign holders. Gripper fins hold securely in either vertical (flag) or horizontal position. Adhesive base adheres to clean, flat surfaces.

- Custom lengths available
- Available without adhesive
- Clear PVC material

ITEM #	LENGTH	BASE WIDTH	HEIGHT	GRIP CAPACITY
108531	1-1/2"	1/2"	1/2"	.125" to .187"
108532	3"	1/2"	1/2"	.125" to .187"
108533	6"	1/2"	1/2"	.125" to .187"

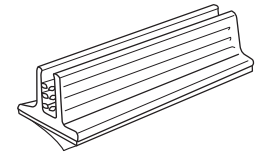

Heavy Duty Gripper Sign Holder – Wide

Heavy duty style holds thicker sign and display material than standard gripper sign holders. Wider base offers more stability. Gripper fins hold securely in either vertical (flag) or horizontal position. Adhesive base adheres to clean, flat surfaces.

- Custom lengths available
- Available without adhesive
- Clear PVC material

ITEM #	LENGTH	BASE WIDTH	HEIGHT	ADHESIVE STYLE	GRIP CAPACITY
140670	1"	1"	7/8"	Standard "Permanent"	.125" to .250"
108527	3"	1"	7/8"	Standard "Permanent"	.125" to .250"
NEW 108527R	3"	1"	7/8"	Optional "Removable"	.125" to .250"
108528	6"	1"	7/8"	Standard "Permanent"	.125" to .250"

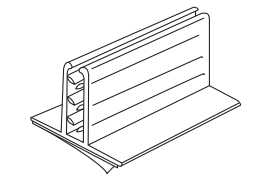

Heavy Duty Gripper Sign Holder – Extra Wide

Gripper fins coupled with extra wide base offers great stability and strength. Gripper fins hold larger signs securely in either vertical (flag) or horizontal position. Adhesive base adheres to clean, flat surfaces.

- Custom lengths available
- Clear PVC material

ITEM #	LENGTH	BASE WIDTH	HEIGHT	GRIP CAPACITY
108547	3"	1-1/2"	1-1/4"	.187" to .250"
108548	6"	1-1/2"	1-1/4"	.187" to .250"

Hinged Gripper Sign Holder

Great for mounting signs in high traffic areas. Flexible hinge swings and returns to original position when bumped. Gripper fins hold sign firmly in vertical (flag) or horizontal position. Adhesive bottom adheres to clean, flat surfaces.

- Custom lengths available
- Available without adhesive (please inquire) or with a magnet (see page 116)
- Clear PVC material

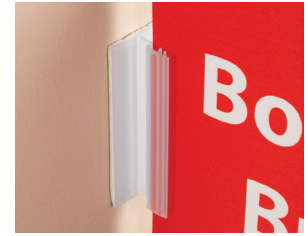
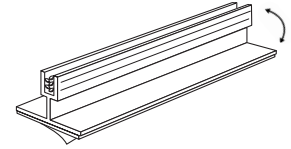

ITEM #	LENGTH	BASE WIDTH	HEIGHT	GRIP CAPACITY
108520	3"	1"	3/4"	up to .100"
108551	3"	1-1/8"	7/8"	.125" to .187"
108751	22"	1"	3/4"	up to .100"
108752	22"	1-1/8"	7/8"	.125" to .187"
108539	36"	1"	3/4"	up to .100"
108552	36"	1-1/8"	7/8"	.125" to .187"

Rotatable Gripper Sign Holder

Two-piece rotating design. Gripper fins hold sign firm in either vertical (flag) or horizontal position. Permanent foam adhesive bottom adheres to any clean, flat surface.

- Maximum viewing angle of 80 degrees
- Custom lengths available
- White PVC material

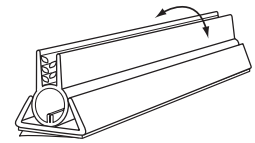

ITEM #	LENGTH	BASE WIDTH	HEIGHT	GRIP CAPACITY
108536	6"	1-1/16"	1"	up to .080"

Wide Base Gripper Sign Holder

Gripper fins coupled with wide base offers extra stability for advertisements or cards. Great for use on table or desk tops as a freestanding unit.

- No adhesive
- Custom lengths available
- Clear PVC material

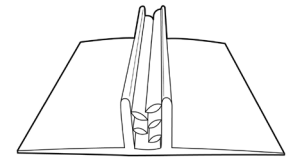

ITEM #	LENGTH	BASE WIDTH	HEIGHT	GRIP CAPACITY
108632	2"	2"	1/2"	up to .080"

Gripper T-Style Table Top Sign Holder

Gripper fins coupled with extra wide base offers great stability for table top signage.

- Custom lengths available
- Also available with adhesive
- Clear PVC material

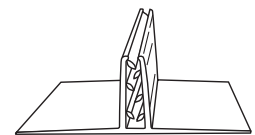

ITEM #	LENGTH	BASE WIDTH	HEIGHT	GRIP CAPACITY
108553	3"	4"	1-3/8"	.187" to .250"
108554	6"	4"	1-3/8"	.187" to .250"



Magnetic Gripper Sign Holder – Light Duty

An economical magnetic gripper for light duty use in low-traffic environments. Flexible hinge swings and returns to original position when bumped. Gripper fins hold signs in vertical (flag) position. (For a stronger magnetic grip, use our Magnetic Gripper Sign Holder – see below.) Removable and reusable.

Warning: Magnets should not be used near electronic equipment.

- 3" long x 1" wide
- No hinge style is 5/8" height and with hinge style is 7/8" height
- Integrated light duty magnetic strip at base made from 1/16" thick flexible black magnet
- Grippers are clear PVC material



ITEM #	DESCRIPTION	GRIP CAPACITY	STYLE
107089	Standard Grip	up to .080"	No Hinge
107092	Standard Grip	up to .100"	With Hinge

Magnetic Gripper Sign Holder

Ideal for warehouse rack system environments, shelf gondolas & freezer cases. Gripper fins hold signs firmly in vertical (flag) position. Versatile magnetic base assures maximum holding power on metal surfaces. Use two or more holders for larger signs. Hinged style option is great for placing signs in high traffic areas. Flexible hinge swings & returns to original position when bumped. Removable & reusable. **Warning:** Magnets should not be used near electronic equipment.

- #107093 & #107095 are 3" long x 3/4" wide base x 3/4" overall height
- #107094 & #107096 are 3" long x 3/4" wide base x 1" overall height
- #108713 is 3" long x 7/8" wide base x 1" overall height
- Permanently attached 7/8" wide x 1/4" height nickel plated steel casing containing ceramic magnets
- Available with optional non-scratch inserts (see page 216)
- Grippers are clear PVC material

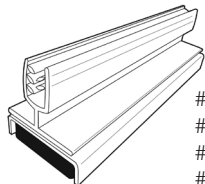

#107093
#107094
#107095
#107096

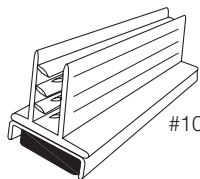

#108713



ITEM #	DESCRIPTION	GRIP CAPACITY	STYLE
107093	Standard Grip	up to .100"	With Hinge
107094	Heavy Duty Grip	.100" to .250"	With Hinge
107095	Standard Grip	up to .100"	No Hinge
107096	Heavy Duty Grip	.100" to .250"	No Hinge
108713	Heavy Duty Grip	.125" to .250"	No Hinge

Magnetic Gripper Sign Holder – Extra Tall

Great for mounting signs horizontally on top of gondolas or other metal fixtures without the need for adhesive. Gripper fins, coupled with extra tall side supports, offer superior graphic holding strength. Versatile magnetic base assures maximum holding power on metal surfaces. Use two or more holders for larger signs. Removable and reusable. **Warning:** Magnets should not be used near electronic equipment.

- 3" long x 7/8" wide base x 1-1/2" overall height
- Permanently attached 7/8" wide x 1/4" height nickel plated steel casing containing ceramic magnets
- Available with optional non-scratch inserts (see page 216)
- Grippers are clear PVC material

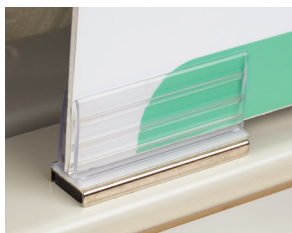
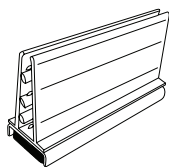

ITEM #	LENGTH	HEIGHT	GRIP CAPACITY
107098	3"	1-1/2"	.187" to .250"

We also offer Magnetic Adapters without grippers – see pages 216 - 218



Magnetic Gripper Flag Sign Holder

Ideal for warehouse rack system environments, shelf gondolas & freezer cases. Gripper fins hold signs firmly in vertical (flag) position. Versatile magnetic base assures maximum holding power on metal surfaces. Use two or more holders for larger signs. Removable & reusable. **Warning:** Magnets should not be used near electronic equipment.

- 1/2" height
- Permanently attached 7/8" wide x 1/4" height nickel plated steel casing containing a ceramic magnet
- Available with optional non-scratch inserts (see page 216)
- Grippers are clear PVC material

ITEM #	LENGTH	GRIP CAPACITY	SIGN POSITION
107097	1"	up to .080"	Flag

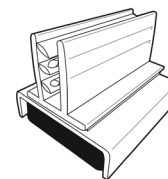

Magnetic Gripper Flush Sign Holder

Ideal for warehouse rack system environments, shelf gondolas & freezer cases. Gripper fins hold signs firmly in horizontal (flush) position. Versatile magnetic base assures maximum holding power on metal surfaces. Use two or more holders for larger signs. Removable & reusable. **Warning:** Magnets should not be used near electronic equipment.

- 3/4" height, "J" style
- Permanently attached 7/8" wide x 1/4" height nickel plated steel casing containing ceramic magnet(s)
- Available with optional non-scratch inserts (see page 216)
- Grippers are clear PVC material

ITEM #	LENGTH	GRIP CAPACITY	SIGN POSITION
107090	1"	up to .080"	Flush
107091	3"	up to .080"	Flush

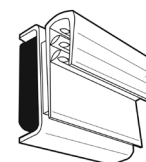

Magnetic Gripper Flush Sign Holder – Light Duty

An economical magnetic gripper for light duty use in low traffic environments. Gripper fins hold sign securely in horizontal (flush) position. (For a stronger magnetic grip, use our Magnetic Gripper Flush Sign Holder – see above). Removable and reusable. **Warning:** Magnets should not be used near electronic equipment.

- 3/4" height, "J" style
- Integrated light duty magnetic strip at base made from 1/16" thick flexible black magnet
- Gripper is clear PVC material

ITEM #	LENGTH	GRIP CAPACITY	SIGN POSITION
107079	3"	up to .080"	Flush

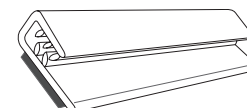

Magnetic Gripper Offset Sign Holder

Great for mounting signs vertically and off to one side from gondola uprights or other metal fixtures without interfering with shelves. Perfect for end cap displays. Gripper fins hold signs firmly in vertical (flag) position. Versatile magnetic base assures maximum holding power on metal surfaces. Use two or more for larger signs. Reversible, removable and reusable. **Warning:** Magnets should not be used near electronic equipment.

- 3" long x 7/8" wide base x 1-1/8" overall height
- Permanently attached 7/8" wide x 1/4" height nickel plated steel casing containing ceramic magnets
- Available with optional non-scratch inserts (see page 216)
- Grippers are clear PVC material
- Also available in other grip ranges or with a hinge feature – please inquire

ITEM #	LENGTH	GRIP CAPACITY	STYLE
107099	3"	.125" to .250"	No Hinge

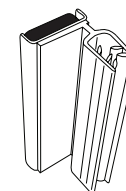

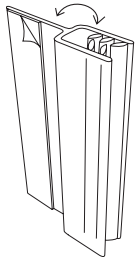

Hinged Gripper Flush Mount Sign Holder

Add flush mounted signs to most square edged gondola end caps, uprights or cross members. Great for mounting signs in high traffic areas in vertical (flag) position. Flexible hinge swings and returns to original position when bumped. Gripper fins hold sign securely. Adhesive edge attaches to any clean, flat surface.

- 3/4" adhesive backed edge width
- Custom lengths available
- Clear PVC material



ITEM #	LENGTH	OVERALL WIDTH	GRIP CAPACITY
108544	3"	1-3/8"	up to .100"
108775	3"	1-5/8"	.100" to .250"
108776	48"	1-5/8"	.100" to .250"

Sign & Literature Holders

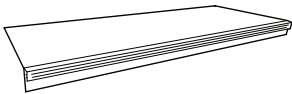

Gripper Shovel Base Sign Holder

Perfect for stacked merchandise – simply insert between layers of product. Gripper fins hold signs firmly in horizontal (flush) position. Can also be used on shelves – slide shovel base over the shelf and under the product.

- 11" long x 4-1/2" deep
- Front gripper fins hold signs up to .080" thick
- Clear PVC material



ITEM #	LENGTH	DEPTH	GRIP CAPACITY	SIGN POSITION
108728	11"	4-1/2"	up to .080"	Flush

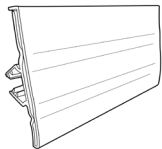

Gripper Covered-Face Sign Holder

Clear face hinges open for top load sign insertion and removal. Covered face with built-in snap closure offers full protection of labels, signs and tickets. Integrated soft gripper fins securely affix to glass or wood shelves and/or wires for a vertical (flush) viewing angle.

- Fits shelves or wires 1/8" to 1/4" thick
- Holds up to 1-1/2" height x 3" long signs
- Custom lengths available
- Clear PVC material



ITEM #	HEIGHT	LENGTH	COLOR
108653	1-1/2"	3"	Clear

Gripper Covered-Face Sign Holder/Protector

Clear face opens for top or side load sign insertion and removal. Scan codes through the clear facing. Economical flush position sign holder and protector that securely mounts directly at the edge of the shelf. Integrated soft gripper fins securely affix to glass or wood shelves.

- Fits shelves 3/16" to 1/4" thick
- Holds up to 3-1/2" height x 5-1/2" long signs
- Custom lengths available
- Clear PVC material

ITEM #	HEIGHT	LENGTH
108794	3-1/2"	5-1/2"



Hinged Gripper Flush Sign Holder

Gripper fins clip securely on the front edge of common wood and glass shelves that are 1/4" thick. Built-in hinge function flips the sign up when stocking shelves. Gripper fins hold sign firmly in horizontal (flush) position. Part is removable and reusable.

- Two grippers joined by an integrated flexible hinge
- 1/2" long horizontal shelf attachment strip has gripper fins that fit 1/4" thick shelves
- Horizontal gripper fins hold signs up to .080" thick
- Clear PVC material

ITEM #	WIDTH	HEIGHT	SIGN POSITION
108108	1"	3/4"	Flush

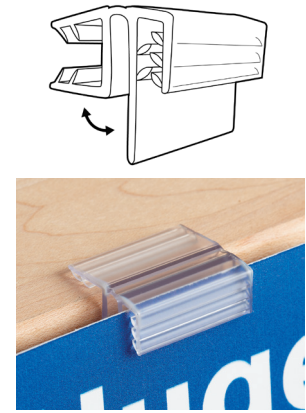

Hinged Gripper Square Shelf Flush Sign Holder

Gripper fins clip securely on the front edge of common metal and wood shelves with two shelf thickness ranges to choose from. Built-in hinge function flips the sign up when stocking shelves below. Gripper fins hold signs firmly in horizontal (flush) position. Parts are removable and reusable.

- Two grippers joined by an integrated flexible hinge
- #108110 has a 1" long horizontal shelf attachment strip with gripper fins and a face height of 3/4"
- #108744 has a 3/4" long horizontal shelf attachment strip with gripper fins and a face height of 1-1/8"
- Horizontal gripper fins hold signs up to .080" thick
- Clear PVC material

ITEM #	WIDTH	FITS SHELF THICKNESS	SIGN POSITION
108110	1-1/2"	1/2" thru 5/8"	Flush
108744	1-1/2"	3/4" thru 1"	Flush

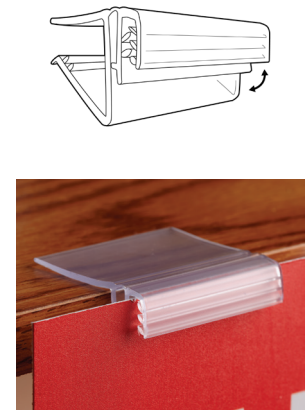

Gripper Square Shelf Flush Sign Holder

Gripper fins clip securely on the front edge of common metal and wood shelves with two shelf thickness ranges to choose from. Gripper fins hold signs firmly in horizontal (flush) position. Parts are removable and reusable.

- #108753 has a 1" long horizontal shelf attachment strip with gripper fins and a face height of 3/4"
- #108754 has a 3/4" long horizontal shelf attachment strip with gripper fins and a face height of 1-1/8"
- Horizontal gripper fins hold signs up to .080" thick
- Clear PVC material

ITEM #	WIDTH	FITS SHELF THICKNESS	SIGN POSITION
108753	1-1/2"	1/2" thru 5/8"	Flush
108754	1-1/2"	3/4" thru 1"	Flush

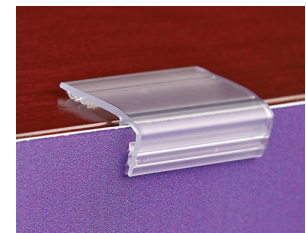
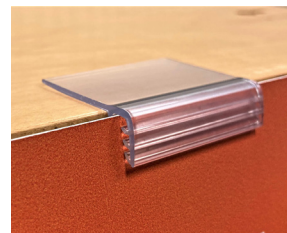
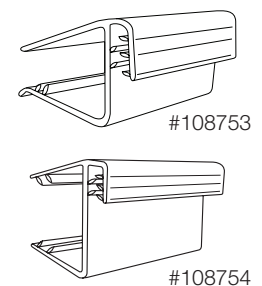

#108753

#108754

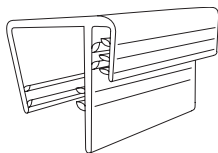

Gripper Square Bin Flush Sign Holder

Gripper fins clip securely on the front of common upright square edge fixtures such as wooden drop bins. Gripper fins hold signs firmly in horizontal (flush) position. Parts are removable and reusable.

- “J” style gripper front area with 1" face height
- Horizontal gripper fins hold signs up to .080" thick
- Clear PVC material



ITEM #	WIDTH	FITS EDGE THICKNESS	SIGN POSITION
108787	1-1/2"	3/4"	Flush

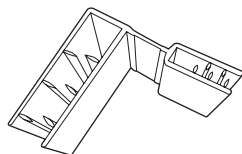

Ceiling Fan Sign Gripper

Fits most ceiling fans on display in a retail environment. Gripper fins on the base attach to the fan blade, while the smaller gripper (leg) holds a sign or pricing material.

- Two grippers joined by an integrated flexible hinge
- 90 degree angle connects 1-1/2" height base to 1-3/4" height leg
- Overall length is 1-1/2"
- Clear PVC material



ITEM #	GRIP CAPACITY OF BASE	GRIP CAPACITY OF LEG	SIGN POSITION
108917	.125 to .250"	up to .100"	Flush

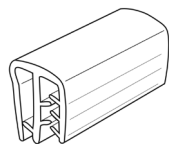

Info Strip Universal Flush Sign Holder

Clips securely onto the face of a wide variety of both thin and thick backer info strip sign holders. Gripper fins hold sign firm in horizontal (flush) position. Part is removable and reusable.

- Double “U” style
- One side fits most info strip label holders
- Other side has gripper fins that hold signs up to .080" thick
- Clear PVC material



ITEM #	LENGTH	HEIGHT	SIGN POSITION
108608	1"	1/2"	Flush

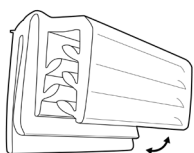

Economy Info Strip Hinged Flush Sign Holder

Clips securely onto the face of a wide variety of both thin and thick backer info strip sign holders. Built-in hinge function flips the sign up when scanning or restocking shelves. Gripper fins hold sign firmly in horizontal (flush) position. Part is removable and reusable.

- Gripper fins hold signs up to .080" thick
- Clear PVC material



ITEM #	LENGTH	HEIGHT	SIGN POSITION
108699	1"	1/2"	Flush

Economy Info Strip Flush Sign Holder

Our most economical flush ticket and sign holder. "U" style with reverse angle gripper fins that clip directly onto the window face of thin style info strips. Part is removable and reusable.

- Gripper fins hold signs up to .080" thick
- Designed to fit most thin info strip label holders in horizontal (flush) position
- Clear PVC material

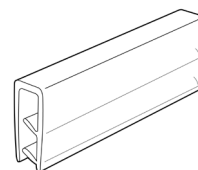

ITEM #	LENGTH	HEIGHT	SIGN POSITION
108503	1-1/2"	1/2"	Flush

Hinged "U" Channel Gripper Sign Holder

Double grippers clip securely onto common shelf info strips. Built-in hinge flips up the sign when shopping or restocking shelves. Gripper fins hold sign firmly in flush position. Removable and reusable.

- Double "U" style
- One side fits most info strip label holders
- Other side holds signs up to .080" thick
- Clear PVC material
- Packaged 100 per bag

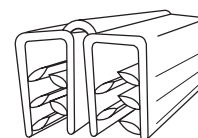

ITEM #	LENGTH	HEIGHT	SIGN POSITION
108981	2"	3/8"	Flush

Perf Shelf Gripper Flush Sign Holder

Fits most round, square or diamond shaped perforated shelf holes. Attaches to shelf with #120400 Perf Shelf White Dart Clip (included). Is removable with a pinch of the dart clip and can be reused. Gripper fins hold sign firm in horizontal (flush) position.

- 1-1/2" length x 3/4" wide with angled front face
- .250" diameter hole for dart clip insertion
- Holds signs up to .080" thick
- Clear PVC material
- Packaged 100 grippers and 100 clips per bag

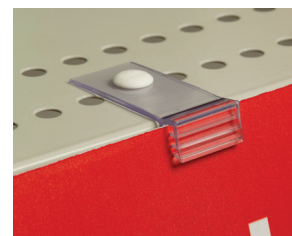

ITEM #	SIGN POSITION
108667	Flush

Self-Piercing Flush Sign Holder

Clip hooks into most standard perforated shelves and securely holds paper signs in flush position. Very popular reusable perf shelf clip featuring a piercing male pin that easily folds and punctures paper signs for a secure hold. A snapping male mechanism ensures that the sign will be held firmly in place.

- 3" overall length
- 1" fold section
- Holds paper signs up to .012" thick
- Natural polypropylene material
- Packaged 100 per bag

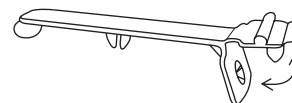

ITEM #	SIGN POSITION
107203	Flush

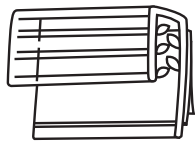

Gripper Flush Sign Holder

Gripper fins hold sign securely in flush position. Can also be snapped over .080" diameter wire with adhesive side used to hold signs, lightweight displays or literature holders. Adhesive backing adheres to any clean, flat surface.

- "J" style with adhesive backing
- Also available with a magnet (see page 117)
- Custom lengths available
- Clear PVC material



ITEM #	LENGTH	HEIGHT	GRIP CAPACITY	SIGN POSITION
108515	1"	3/4"	up to .080"	Flush
108516	1-1/2"	3/4"	up to .080"	Flush
108517	3"	3/4"	up to .080"	Flush
108618	48"	3/4"	up to .080"	Flush

Heavy Duty Gripper Flush Sign Holder

Heavy duty style holds thicker signs securely in flush position. Also can be snapped over wire up to .250" diameter with the adhesive side used to hold signs, displays or literature holders. Adhesive backing adheres to any clean, flat surface.

- "J" style with adhesive backing
- Also available with a magnetic backing
- Custom lengths available
- Clear PVC material

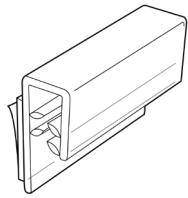

ITEM #	LENGTH	HEIGHT	GRIP CAPACITY	SIGN POSITION
108542	1-1/2"	1"	up to .250"	Flush
108543	3"	1"	up to .250"	Flush
108612	48"	1"	up to .250"	Flush

Gripper Flip-Up Flush Sign Holder

Gripper joined by flip-up flexible hinge to an adhesive backed shelf attachment strip. Great for shelves or countertops. Gripper fins hold sign securely in flush position while built-in hinge function flips up sign to reveal labels or inventory on shelving below.

- 7/8" height x .031" thick adhesive backed shelf attachment strip
- 3/4" height "J" style flush gripper
- Custom lengths also available
- Clear PVC material

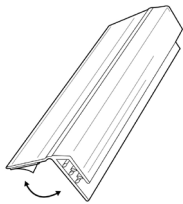

ITEM #	LENGTH	GRIP CAPACITY
108593	3"	up to .080"

Perf Shelf Flush Sign Holder With Adhesive

Fits most round, square or diamond shaped perforated shelf holes. Attaches to shelf with #120400 Perf Shelf White Dart Clip (included). Is removable with a pinch of the dart clip. Permanent adhesive holds signs, coupon pads or take-one promotions in horizontal (flush) position.

- 2" overall length x 3/4" wide
- Angled shelf front adhesive area is 1" long x 3/4" wide
- .250" diameter hole for dart clip insertion
- Clear PVC material
- Packaged 100 sign holders and 100 clips per bag

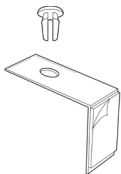

ITEM #	SIGN POSITION
108664	Flush

Self-Piercing Channel Flush Holder

Clips into standard shelf price channels and securely holds paper signs flush to shelf. Very popular, reusable shelf clip featuring a piercing male pin that easily folds and punctures paper signs for a secure hold. Great for ever-changing sale signs.

- 1-1/8" wide x 1-3/4" overall height (1-1/4" folded height)
- Holds paper signs up to .012" thick
- Fits standard 1-1/4" shelf price channels
- Natural polypropylene material
- Packaged 50 per bag

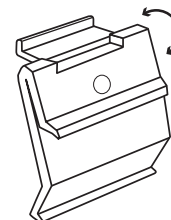

ITEM #	SIGN POSITION
107202	Flush



Gripper UPC Tag/Sign Holder

A more heavy duty version of our common Gripper Shelf Channel Sign Holder. Gripper fins hold signs firmly in flush position. Legs snap securely into price channel. Has an extra gripper fin for added strength and sign support. Great for ever-changing, one sided sale signs.

- 1-1/4" face height (1-5/8" overall height)
- Fits into standard 1-1/4" shelf price channels
- Gripper fins hold signs & tags up to .080" thick
- Clear PVC material



ITEM #	LENGTH	COLOR
108637	1-1/4"	Clear



Gripper Shelf Channel Sign Holder

Very popular shelf price channel clip that is reusable and easy to insert. Gripper fins hold signs firmly in flush position. Legs snap securely into price channel. As an added bonus, our leg tips have a bead of soft vinyl for a more secure fit. Great for ever-changing, one sided sale signs.

- 1-1/4" height
- Fits into standard 1-1/4" shelf price channels
- Gripper fins hold signs up to .080" thick
- Clear PVC material
- Also available in black



ITEM #	LENGTH	COLOR
108638	1/2"	Clear
108639	1"	Clear



Gripper Long Leg Shelf Channel Sign Holder

A more heavy duty, secure fit version of our common Gripper Shelf Channel Sign Holder. Gripper fins hold signs firmly in flush position. Integrated extra long top leg adds extra strength and snaps securely into price channel. Great for ever-changing, one sided sale signs.

- 1-1/4" height
- Longer leg for a more secure fit in shelf channel
- Fits into standard 1-1/4" shelf price channels
- Gripper fins hold signs up to .080" thick
- Clear PVC material



ITEM #	LENGTH	COLOR
108683	1"	Clear



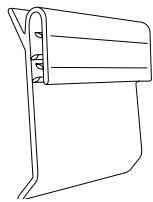

Easy-Flex Shelf Channel Sign Holder

This economical version is even easier to insert into price channels than our standard Gripper Shelf Channel Sign Holder. The clip itself flexes and springs back as the legs snap securely into place. Gripper fins holds signs firmly in flush position – an added bonus versus our competition. Great for ever-changing, one-sided sale signs.

- 1-1/4" height
- Fits into standard 1-1/4" shelf price channels
- Gripper fins hold signs up to .080" thick
- Clear PVC material



ITEM #	LENGTH	COLOR
108726	1-1/4"	Clear

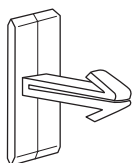

Channel Mount Arrow Fastener

Flexible arrow tip deflects when pushed into hole then springs back as a clip that resists removal. Ideal for take-one promotions. Inexpensive way to display coupon pads, books or signs. Base with adhesive securely snaps into standard 1-1/4" shelf price channels. Base with adhesive adds extra strength when pressed into shelf price channel, or can also be used on any clean, flat surface.

- Base is .500" wide x 1.200" long
- Available with or without adhesive
- Fits 1-1/4" shelf price channels
- Required hole size is 1/4" to 9/32" diameter
- Natural polypropylene material
- Packaged as shown below



ITEM #	STEM LENGTH	PAD THICKNESS	STYLE	PACKAGED
120456	1/2"	up to 7/16"	No Adhesive	250 per bag
120457	1/2"	up to 7/16"	With Adhesive	250 per bag
120458	15/16"	up to 7/8"	No Adhesive	100 per bag
120459	15/16"	up to 7/8"	With Adhesive	100 per bag

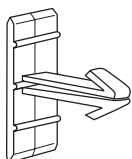

Easy-Flex Channel Mount Arrow Fastener

Our most popular arrow fastener designed for even easier insertion into standard 1-1/4" shelf price channels. Flexible arrow tip deflects when pushed into hole then springs back as a clip that resists removal. Ideal for take-one promotions. Inexpensive way to display coupon pads, books or signs.

- Base is .437" wide x 1.200" long, without adhesive
- Fits 1-1/4" shelf price channels
- Required hole size is 1/4" to 9/32" diameter
- Natural polypropylene material
- Packaged 250 per bag



ITEM #	STEM LENGTH	PAD THICKNESS	STYLE
120455	1/2"	up to 7/16"	No Adhesive

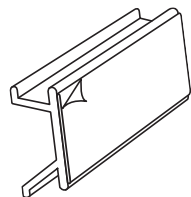

Channel Mount With Adhesive

Securely mounts a variety of signs, coupon books/boxes or lightweight displays to shelf price channels. Also known as Advertiser Rail Clips.

- 1-1/4" height, with 1" height adhesive
- Extends approximately 1/2" from shelf
- Also available in custom lengths
- Fits standard 1-1/4" shelf price channels
- Clear PVC material



ITEM #	LENGTH	STYLE
107123	1"	Flush With Adhesive
107124	2"	Flush With Adhesive

Sign & Literature Holders

Shelf Channel Adapter With Screw

Securely mounts to a variety of signs, coupon books/boxes or lightweight displays to shelf price channels. Integrated screw design provides a secure fit directly into price channels with the turn of an attached Phillips/slotted combo pan head metal screw. Dual 3/16" round and slotted holes located behind the adhesive offer additional mounting options such as 3/16" pop rivets.

- 7/8" face height, with 3/4" height adhesive
- Extends approximately 7/8" from shelf
- Fits standard 1-1/4" shelf price channels
- Beige ABS material

ITEM #	LENGTH	STYLE
107181	2-1/2"	Flush With Adhesive

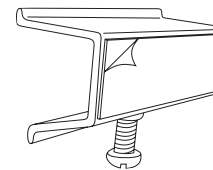

Metal Shelf Channel Adapter With Screw

Stronger than common extruded or injection molded shelf channel adapters. Securely mounts to a variety of heavier signs, acrylic boxes or literature holders to shelf price channels. Integrated thumb screw design requires no tools while providing a secure fit. Four evenly placed face plate holes offer numerous mounting options such as screws or 3/16" pop rivets. Removable and reusable.

- 7/8" face height with four 3/16" diameter holes
- Extends approximately 1" from shelf
- Fits standard 1-1/4" shelf price channels
- Assembled eye screw is 10-24 x 1-1/2" long, zinc plated steel
- Spring steel material with zinc plate

ITEM #	LENGTH	STYLE
107180	3"	Flush With Mounting Holes

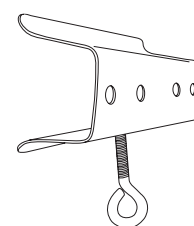

Metal Mini Shelf Channel Adapter With Screw

A smaller but sturdy version of our Metal Shelf Channel Adapter With Screw (see above). Stronger than common extruded or injection molded shelf channel adapters. Securely mounts to a variety of heavier signs, acrylic boxes or literature holders to shelf price channels. Integrated Phillips screw design provides a secure fit. Also features a 1/4" wide slotted top and bottom hole that can be used with our Metal Merchandising Strips (see page 76). Removable and reusable.

- 5/8" face height with one 9/64" diameter hole
- Extends approximately 7/8" from shelf
- Fits standard 1-1/4" shelf price channels
- Assembled screw is 10-24 x 1" long, zinc plated steel
- Spring steel material with zinc plate

ITEM #	LENGTH	STYLE
107154	1-3/4"	Flush With Mounting Holes

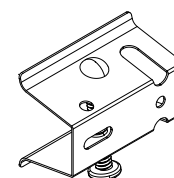

Slim-Line Dual Mount Sign Protector

Very economical flush-position sign protector. Flexible and crystal clear. Securely mounts to most standard shelf price channels directly at the edge of the shelf, and in a tilted viewing angle that does not block or interfere with the products on the shelf. Centered mounting strip insures your signage will be centered both above and below the shelf. Can also be inserted securely into the face of a wide variety of both thin and thick backed info strip sign holders.

- Fits standard 1-1/4" shelf price channels
- Custom lengths also available
- 15 mil thick, clear rigid PVC material

ITEM #	HEIGHT	LENGTH
150327	2-1/4"	4-1/4"
150161	3-1/2"	5-1/2"



Slim-Line Sign Protector

Very economical flush-position sign protector. Flexible and crystal clear. Securely mounts to most standard shelf price channels directly at the edge of the shelf, and in a tilted viewing angle that does not block or interfere with the products on the shelf. Off-centered mounting strip allows your signage to be displayed either above or below the shelf. Can also be inserted securely into the face of a wide variety of both thin and thick backed info strip sign holders.

- Fits standard 1-1/4" shelf price channels
- Custom lengths also available
- Clear rigid PVC material

	ITEM #	HEIGHT	LENGTH	THICKNESS
NEW	150009	2-1/2"	3-1/2"	15 mil
	150163	3"	5"	12 mil
NEW	150366	3"	5"	15 mil
	150160	3-1/2"	5-1/2"	15 mil
	150164	7"	11"	12 mil



Slim-Line Oversized Sign Protector

Unlike our traditional line of flush-position Slim-Line Sign Protectors, this "oversized" style is designed to hang perpendicular to the shelf top and not to slant or tilt. Securely mounts to most standard shelf price channels directly at the edge of the shelf. As an added feature, the integrated snap-fit mounting strip ensures your signs rise a bit above the shelf to attract attention. Flexible and crystal clear.

- Fits standard 1-1/4" shelf price channels
- Each print protector width is approximately 3/16" wider than the actual recommended sign size shown below
- Custom sizes and lengths also available – please inquire
- 15 mil thick, clear PVC material
- Packed 25 per bag

ITEM #	SIGN SIZE	STYLE
107413	8-1/2" Width x 5-1/2" Height	Landscape
107412	8-1/2" Width x 11" Height	Portrait



Mid-Channel Mount Sign Protectors

Economical, clip-in sign protector for common shelf fronts. Flexible and crystal clear. Securely mounts to most standard shelf price channels at a tilted viewing angle. Can also be inserted into the face of a variety of info strip sign holders.

- 12 mil thick
- Fits standard 1-1/4" shelf price channels
- Two lengths to choose from
- Custom lengths available - please inquire
- Clear, heat-bent PVC material

ITEM #	HEIGHT	LENGTH
150123	3-1/2"	5-1/2"
150124	3-1/2"	11"

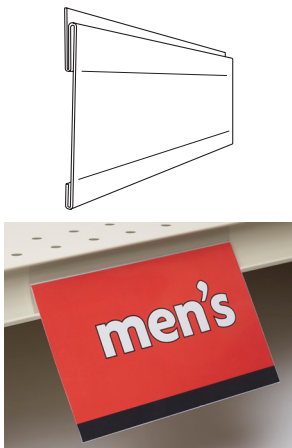

Center Shelf Mount Covered-Face Sign Holder

Center signs neatly on shelves. Covered-face sign holder protects literature off common “C” channel shelving fronts. Snap-in back is centered to hang equally above and below the shelf. Signs are protected behind the clear face. Removable and reusable.

- 50 mil thick
- Fits common 1-1/4" shelf channels
- Custom lengths available - please inquire
- Clear rigid PVC material

ITEM #	HEIGHT	LENGTH
140701	3-1/2"	5-1/2"

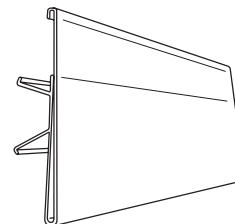

Hinged “C” Channel Covered-Face Sign Holder

Covered face design that easily accepts and protects common signs directly off of common “C” channel shelving fronts. Built-in hinge function flips the sign up when stocking inventory below. Scan codes through the clear facing. Part is removable and reusable.

- Designed to fit into common 1-1/4" height shelf price channels
- Holds 3-1/2" height x 5-1/2" long signs in flush position
- Custom lengths available – please inquire
- Clear PVC material

ITEM #	HEIGHT	LENGTH
108881	3-1/2"	5-1/2"

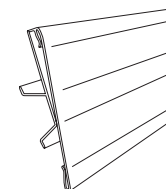

Economy Covered-Face Center Mount Sign Holder

Economically holds and protects signs or UPC inserts on most standard shelf price channels directly at the edge of the shelf while at a tilted viewing angel. Centered, snap-fit mounting strip insures your signage will be located both above and below the shelf. Scan codes through the flexible clear facing. Change signs with easy side insertion/removal. Extruded design that is both thicker and more durable than common heat bent protectors.

- Snap fits into most standard 1-1/4" height shelf price channels
- Custom lengths available – please inquire
- Clear PVC material

	ITEM #	HEIGHT	LENGTH	SIGN POSITION
	108760	3-1/2"	5-1/2"	Flush
NEW	150375	2-7/8"	4-3/4"	Flush
NEW	150376	3-1/2"	7-3/4"	Flush

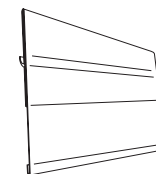

Multi-Mount Covered-Face Sign Holder

A single solution for at least three uses throughout the store. Attaches to most 1-1/4" height shelf channels, wire fixtures up to .375" diameter and panels of .080" to .250" thick. Signs and literature are held firmly, protected behind the clear facing. Removable and reusable.

- 40 mil thick
- Clear rigid PVC material
- Custom lengths and sizes available – please inquire

ITEM #	HEIGHT	LENGTH
150153	3-1/2"	5-1/2"

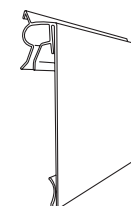

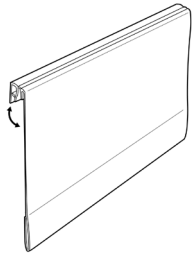

Universal Info Strip Hinged Covered-Face Sign Holder

Clips securely onto the face of a wide variety of both thin and thick backer info strip sign holders. Hold signs firm in horizontal (flush) position. Integrated hinge allows the sign to flip up for easy access to inventory or scanning below. Removable and reusable.

- Integrated hinge connects full face window front to gripper
- "U" style single fin gripper is designed to fit most info strip label holders
- Clear PVC material

ITEM #	LENGTH	HEIGHT	SIGN POSITION
108594	5-1/2"	3-1/2"	Flush



Sign & Literature Holders

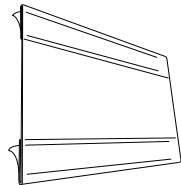

Covered Face Channel With Adhesive

Scan codes through the clear facing. Economically hold and protect signs or UPC inserts on pallet rack cross members or any other flat, clean surface. Change signs with easy side insertion/removal.

- Holds common 3-1/2" height x 5-1/2" long signs
- Two strips of adhesive – one top and one bottom
- Custom lengths available
- Clear PVC material
- Also available in non-glare material – please inquire

ITEM #	HEIGHT	LENGTH
150162	3-1/2"	5-1/2"



Shelf-Top Flag Sign Holder

Capture customer attention with aisle signage in flag position. Unique display arm securely holds signs perpendicular to shelf. Universal mounting tabs hook into most standard perforated shelves – round or diamond hole. Signs with pre-punched top holes easily traverse onto end of display arm.

- 7-1/2" overall length with 1-5/32" base width
- Holds paper signs up to .024" thick
- Sign requires minimum 7/32" diameter hanging holes
- Recommended for signs 4" to 6" wide
- Beige glass filled nylon material

ITEM #	OVERALL LENGTH	SIGN POSITION
107225	7-1/2"	Flag

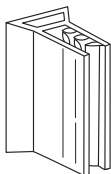

Gripper Twist-In Sign Holder

Just insert base of clip into standard shelf price channel and twist-in for secure locking action. Gripper fins hold sign firm in vertical position. Part is removable and reusable.

- 1-1/4" long (1.150" cut length) x 5/8" overall height
- Base is 1/2" wide
- Holds material up to .080" thick
- Fits standard 1-1/4" shelf price channels
- Clear PVC material

ITEM #	SIGN POSITION
108549	Flag



Self-Piercing Flag Sign Holder

Clip hooks into most standard perforated shelves and securely holds paper signs perpendicular to shelf. Very popular, reusable perf shelf clip featuring a piercing male pin that easily folds and punctures paper signs for a secure hold.

- 3" overall length
- 3/4" fold section
- Holds paper signs up to .012" thick
- Natural polypropylene material
- Packaged 100 per bag

ITEM #	SIGN POSITION
107200	Flag

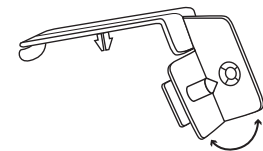

Perf Shelf Gripper Flag Sign Holder

Fits most round, square or diamond shaped perforated shelf holes. Attaches to shelf with #120400 Perf Shelf White Dart Clip (included). Is removable with a pinch of the Dart Clip and can be reused. Gripper fins hold sign firm in vertical (flag) position.

- 2" overall length x 3/4" wide
- Angled shelf front gripper area is 1-1/8" long x 9/16" height
- .250" diameter hole for Dart Clip insertion
- Holds signs up to .080" thick
- Clear PVC material
- Packaged 100 grippers and 100 clips per bag

ITEM #	SIGN POSITION
108104	Flag

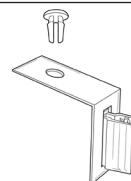

Self-Piercing Channel Flag Holder

Clips into standard price channels and securely holds paper signs. Very popular, reusable perf shelf clip featuring a piercing male pin that easily folds and punctures paper signs for a secure hold. Two styles to choose from: Standard holds signs at a slightly upward angle (i.e. parallel to the angled shelf channel), and Angled which holds signs perpendicular to the shelf surface. Great for ever-changing sale signs.

- 3/4" wide x 1-1/4" height
- 7/8" fold section
- Holds paper signs up to .012" thick
- Fits standard 1-1/4" shelf price channels
- Natural polypropylene material
- Packaged 50 per bag

ITEM #	STYLE	SIGN POSITION
107201	Standard	Flag
107209	Angled	Flag

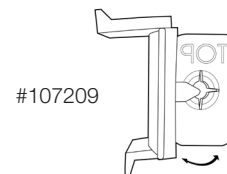
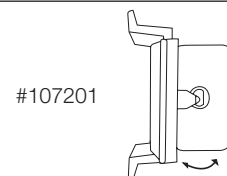

Heavy Duty Self-Piercing Channel Flag Holder

Clips into standard price channels and securely holds paper signs. Reusable perf shelf clip featuring two self-piercing male pins with built-in finger protectors that easily fold and puncture paper signs for a secure hold. Unlike our other self-piercing sign holders, this heavy duty style clip is specifically designed for larger/thicker signs held in flag position (i.e. perpendicular to the shelf surface). Great for ever-changing sale signs.

- 1" wide x 2-1/8" height
- Dual 3/4" fold sections with finger protectors
- Holds paper signs up to .015" thick
- Fits standard 1-1/4" shelf price channels
- Natural polypropylene material
- Packaged 500 per bag

ITEM #	SIGN POSITION
107211	Flag

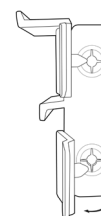

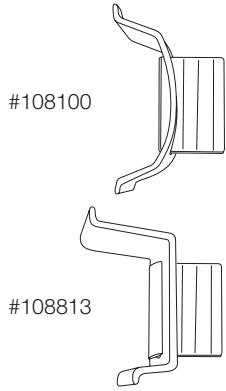

Price Channel Gripper Flag Sign Holder

Just insert base of clip into shelf price channel. Gripper fins hold sign firmly in vertical (flag) position. Two styles to choose from: Standard holds signs at a slightly upward angle (i.e. parallel to the angled shelf channel) and Angled (**Patented**) which holds signs perpendicular to the shelf surface (i.e. parallel to the floor). Both parts are removable and reusable.

- 1-3/8" long x 3/4" wide x 7/8" height
- Fits standard 1-1/4" shelf price channels
- Holds signs up to .080" thick
- Clear PVC material
- Also available in black

ITEM #	STYLE	SIGN POSITION
108100	Standard	Flag
108813	Angled	Flag

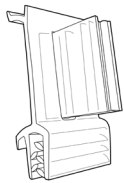

Gripper Dual Action Flag Sign Holder

Versatile price channel clip that is reusable and easy to insert – just insert legs into shelf price channel. Gripper fins hold signs firmly and simultaneously in both flush (up or down) and/or flag position.

- 1-5/8" overall height x 3/4" length
- Fits into standard 1-1/4" shelf price channels
- Both sets of gripper fins hold signs up to .080" thick
- Clear PVC material

ITEM #	SIGN POSITION
108106	Flush/Up, Flush/Down & Flag

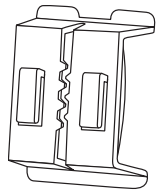

Price Channel Sign Holder

Our most economical shelf edge clip. Extremely versatile clip that securely holds all types of signs in three positions: flush/up, flush/down or flag. Snaps securely to fit standard shelf price channels.

- 1-3/8" long x 1" wide x 3/4" height
- Holds material up to .060" thick
- Fits standard 1-1/4" shelf price channels
- Natural translucent polypropylene material
- Packaged 50 per bag

ITEM #	SIGN POSITION
107125	Flush/Up, Flush/Down & Flag



Info Strip Gripper Flag Sign Holder

Clips securely onto the face of most thin backer, economy style info strips such as our shorter height Self-Adhesive Info Strips (see page 28). Gripper fins hold sign firmly in vertical (flag) position. Two styles to choose from: Standard holds signs at a slightly upward angle (i.e. parallel to the angled shelf channel) and Angled (**Patented**) which holds signs parallel to the floor. Both parts are removable and reusable.

- 1-1/2" long x 3/4" wide x 9/16" height
- Gripper fins hold signs up to .080" thick
- Clear PVC material

ITEM #	STYLE	SIGN POSITION
108102	Standard	Flag
108812	Angled	Flag



#108102

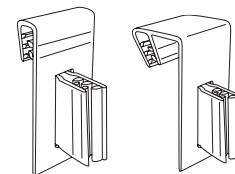

#108102

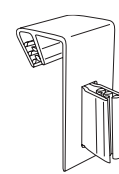

#108812



#108812

Info Strip Hinged Gripper Flag Sign Holder

Clips securely onto the face of most thin backer, economy style info strips such as our shorter height Self-Adhesive Info Strips (see page 28). Built-in hinge function flips the sign up when scanning or restocking shelves. Gripper fins hold sign firmly in vertical (flag) position. Part is removable and reusable.

- Gripper fins hold signs up to .080" thick
- Integrated hinge joins gripper to a 1/2" long self attachment strip
- Clear PVC material

ITEM #	LENGTH	WIDTH	HEIGHT	SIGN POSITION
108101	1-1/8"	3/4"	9/16"	Flag

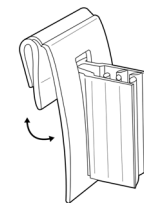

Info Strip Hinged Angled Style Universal Flag Sign Holder

Clips securely onto the face of a wide variety of both thin and thick backer info strip sign holders, such as our Flip-Up Covered Face Sign Holder (see page 32) and our Below Shelf Sign Holder (see page 33). Unlike our other common hinged style flag sign holders, this unique "angled" style is specifically designed to hold signs more parallel to the floor rather than slightly upward. Built-in hinge function flips the sign up when scanning or restocking shelves (**Patent Pending**). Gripper fins hold signs firmly in vertical (flag) position. Part is removable and reusable.

- Integrated hinge and extended support joins gripper to a 1/2" long shelf attachment strip
- Gripper fins hold signs up to .080" thick
- Clear PVC material

ITEM #	LENGTH	WIDTH	HEIGHT	SIGN POSITION
108898	1-1/2"	3/4"	9/16"	Flag

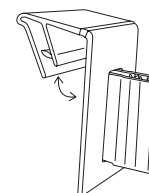

Info Strip Hinged Universal Flag Sign Holder

Clips securely onto the face of a wide variety of both thin and thick backer info strip sign holders, such as our Flip-Up Covered Face Sign Holder (see page 32) and our Below Shelf Sign Holder (see page 33). Built-in hinge function flips the sign up when scanning or restocking shelves. Gripper fins hold sign firmly in vertical (flag) position. Part is removable and reusable.

- Integrated hinge joins gripper to a 1/2" long self attachment strip
- Gripper fins hold signs up to .080" thick
- Clear PVC material

ITEM #	LENGTH	WIDTH	HEIGHT	SIGN POSITION
108103	1"	3/4"	9/16"	Flag

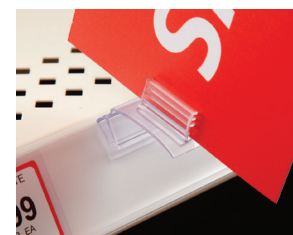
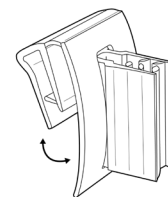

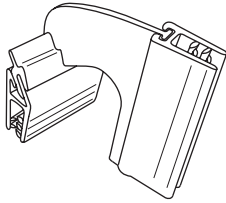

Gripper Extended Sign Holder

Clips securely onto the face of most thin backer, economy style info strips such as our shorter height self-adhesive info strips (see page 28). Gripper fins securely hold signs in an extended fashion for greater, eye-catching visibility in vertical (flag) position. Part is removable and reusable.

- 1-3/4" overall assembled length
- Integrated contoured connecting arm extends 1-1/4"
- Gripper fins hold signs up to .080" thick
- Parts come fully assembled
- Clear PVC material with clear polypropylene arm

ITEM #	LENGTH	WIDTH	SIGN POSITION
108866	1-1/2"	1"	Flag

Sign & Literature Holders

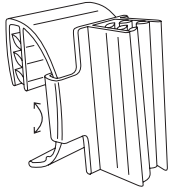

Info Strip Multi-Position Flag Sign Holder

Clips securely onto the face of a wide variety of both thin and thick backer info strip sign holders, such as our Flip-Up Covered Face Sign Holder (see page 32) and our Below Shelf Sign Holder (see page 33). Unique, two-piece design that allows for varying angle adjustments for perfect-view positioning of signs. Gripper fins hold sign firmly in vertical (flag) position. Part is removable and reusable.

- Gripper fins hold signs up to .100" thick
- Two-piece ratcheting design
- Parts come pre-assembled
- Clear PVC material

ITEM #	LENGTH	WIDTH	HEIGHT	SIGN POSITION
108882	1-1/4"	7/8"	1-1/8"	Adjustable Flag

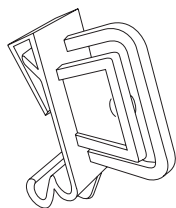

Info Strip Flag Sign Holder

Clips securely onto the clear window face of most thin backer, economy style info strips such as our shorter height Self-Adhesive Info Strips (see page 28). Securely hold signs at a slightly upward angle in vertical (flag) position. Part is removable and reusable.

- Contoured bottom lip design fits both 1-1/4" and 1-1/2" height info strips
- Friction fit dart design holds signs up to .035" thick
- Minimum 3/16" diameter pre-punched hole in sign is recommended
- Natural translucent polypropylene material
- Packaged 100 per bag

ITEM #	WIDTH	HEIGHT	SIGN POSITION
108111	5/8"	1-5/8"	Flag

Hinged Gripper Flag Sign Holder

Gripper fins clip securely on the front edge of common wood and glass shelves that are 1/4" thick. Built-in hinge function flips the sign up when stocking shelves. Gripper fins hold sign firmly in vertical (flag) position. Part is removable and reusable. Use two or more holders from shelf to shelf for blade (or larger) signs.

- Two grippers joined by an integrated flexible hinge
- 1/2" long horizontal shelf attachment strip has gripper fins that fit 1/4" thick shelves
- Vertical gripper fins hold signs up to .080" thick
- Clear PVC material

ITEM #	LENGTH	WIDTH	HEIGHT	SIGN POSITION
108107	1-1/4"	3/4"	9/16"	Flag

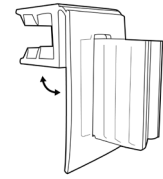

Hinged Gripper Square Shelf Flag Sign Holder

Gripper fins clip securely on the front edge of common metal and wood shelves that are 3/4" thick. Built-in hinge function flips the sign up when stocking shelves. Gripper fins hold sign firmly in vertical (flag) position. Use two or more holders from shelf to shelf for blade (or larger) signs. Part is removable and reusable.

- Two grippers joined by an integrated flexible hinge
- 1" long horizontal shelf attachment strip has gripper fins that fit 3/4" thick shelves
- Vertical gripper fins hold signs up to .080" thick
- Clear PVC material

ITEM #	LENGTH	WIDTH	HEIGHT	SIGN POSITION
108109	1"	3/4"	9/16"	Flag

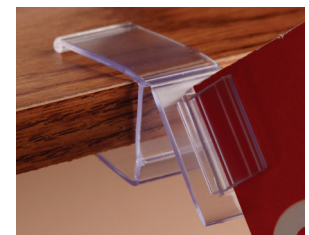
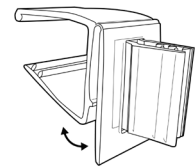

Gripper Scan Plate Flag Holder

Gripper fins hold and join a sign panel to common scan plates at a fixed 90 degree angle in vertical (flag) position. Part is removable and reusable.

- For use with metal scan plates or plastic label holders
- 90 degree angle connects 5/8" height leg to 3/4" height leg
- Clear PVC material

ITEM #	LENGTH	GRIP CAPACITY OF 5/8" LEG	GRIP CAPACITY OF 3/4" LEG	SIGN POSITION
108579	3/4"	up to .120"	up to .080"	Flag

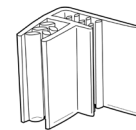

Two-Way Gripper Sign Holder

Gripper fins hold signs simultaneously in either flush or flag position from the sides of displays, other signs or directly to wire fixtures. Use two or more for larger signs.

- 1" long x 5/8" overall height with incorporated 90 degree right angles
- Holds material two ways, with both up to .080" thick
- Clear PVC material

ITEM #	LENGTH	SIGN POSITION
108756	1"	Flag & Flush (simultaneously)

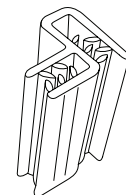

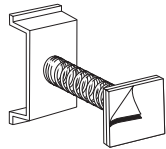

Channel Mount Spring Wobbler

One end snaps securely to fit most standard shelf price channels, other end adheres to signs or promotional items. Lightweight, lively metal spring creates attention grabbing action.

- 1" long, with 11/32" O.D. metal spring center
- 3/4" square adhesive-backed mount on one end and shelf price channel mount on other end
- Fits standard 1-1/4" shelf price channels
- Ends are white polypropylene material
- Packaged 100 per bag



ITEM #	STYLE
107131	Channel mount on one end & adhesive-backed on other end

Sign & Literature Holders

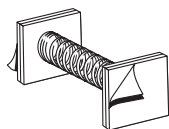

Spring Wobbler

Cost-effective way to add motion to any sign, display or promotional item. Lightweight, lively metal spring creates attention grabbing action. Mounting ends adhere to any clean, flat surface.

- 1" long, with 11/32" O.D. metal spring center
- 3/4" square adhesive-backed mounting ends
- Ends are white polypropylene material
- Packaged 100 per bag

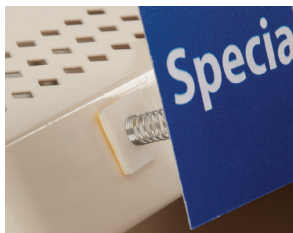

ITEM #	STYLE
107130	Adhesive-backed mounts on both ends

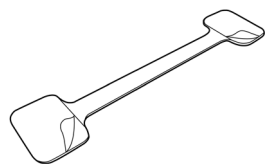

Aluminum Twist Sign Holder

Simple peel-and-stick adhesive end pads securely attach to fixtures and/or lightweight signs. Pliable, soft aluminum construction is designed to twist, pivot or bend for unique viewing angles. Two common lengths to choose from. Sticks to any clean, flat surface.

- Standard design has two adhesive pads – each end has a pad on the “front” side only
- Optional design has three adhesive pads – one end has a pad on the “front” side only and the other end has a pad on both the “front” and “back” sides
- Adhesive pads are 1/2" height x 11/16" width
- Soft aluminum material



ITEM #	LENGTH	ADHESIVE STYLE
140411	3-1/8"	3 Pads (Optional)
140412	6"	2 Pads (Standard)
140413	6"	3 Pads (Optional)

Wobbler – Straight

A simple and inexpensive way to add motion and dimension to any lightweight sign or display. Specifically made from thin material to add extra motion. Can be used on a variety of retail fixtures or displays. Two common lengths to choose from.

- Clear adhesive tape on both ends
- Both lengths are straight cut with 3/8" width
- 10 mil clear PVC material
- Packaged 1,000 pieces per roll
- Sold in full rolls only

ITEM #	LENGTH	COLOR
140402	4"	Clear
140403	6"	Clear

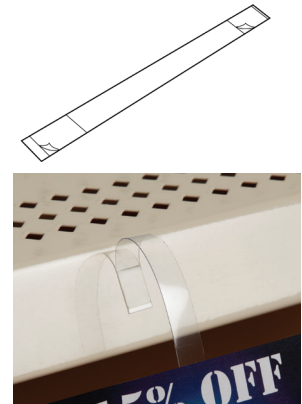

Wobbler – Tapered

A simple way to add motion and dimension to any lightweight sign or display. Tapered design and extra material thickness combine to create additional motion when compared to straight wobblers. Can be used on a variety of retail fixtures or displays. Two common lengths to choose from.

- Clear adhesive tape on both ends
- Both lengths are 9/32" wide on one end and 3/4" wide on the other end
- 15 mil clear PVC material
- Packaged 100 pieces per bag (10 pieces per sheet; 10 sheets per bag)
- Sold in full bags only

ITEM #	LENGTH	COLOR
140400	6"	Clear
140401	8"	Clear

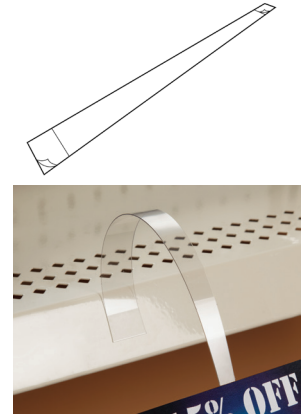

Channel Wobbler Sign Holder

Add motion and dimension to your signage with this all-in-one, crystal clear wobbler sign holder.

- Holds common 3-1/2" height x 5-1/2" long signs
- Fits standard 1-1/4" shelf price channels
- Custom sizes available
- 15 mil thick, clear rigid PVC material

ITEM #	HEIGHT	LENGTH
140501	3-1/2"	5-1/2"



Clear Display Hanger Strip

Showcase multiple clothing items quickly and easily with this durable, flexible strip. Great for hanging, suspending and displaying garments for any occasion, message or season one above the other. To use, simply hook one hanger through an upper hole and a second hanger through a lower hole as desired. Great tool for upsells.

- 1" wide x .025" thick material
- 11 hanging holes each at 5/8" diameter
- Solid, full-length strip
- Strip only – hangers not included
- Elegant rounded corners
- .25 mil thick clear PVC material

ITEM #	OVERALL LENGTH	HANGING POSITIONS
150157	15-3/4"	11 Holes



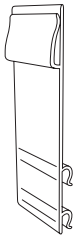

Wire Grid Sign Holder

Friction fit signs and header cards above wire grid fixtures for increased visibility. Great for use on most standard power wing fixtures. Double clip-on design firmly attaches to wires and prevents rotation.

- Fits 1" wire grid fixtures up to .188" diameter
- Friction fit sign grip area is 7/8" deep
- Holds signs up to .125" thick in flush position
- 1-1/4" wide
- Custom widths available
- Clear PETG material

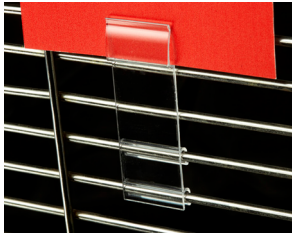

ITEM #	OVERALL HEIGHT
108868	3-3/4"



Gripper Wire Grid Sign Holder

Display signs and header cards above wire grid fixtures for increased visibility. Great for use on most standard power wing fixtures. Double clip-on design firmly attaches to wires and prevents rotation.

- Fits 1" wire grid fixtures up to .188" diameter
- Extra deep sign gripper area is 1" long
- Holds signs up to .125" thick in flush position
- 1-1/4" wide
- Custom widths available
- Clear PVC material

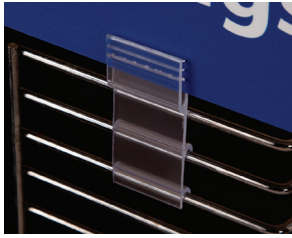

ITEM #	OVERALL HEIGHT
108590	3-7/8"

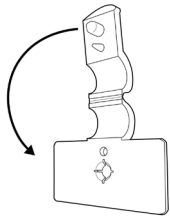

Self-Piercing Wire Flush Sign Holder

Attaches data tickets, tags or signs quickly and easily to wire baskets, grids and displays. Great for ever-changing sale signs. Removable and reusable.

- Holder is self attaching/piercing with dual male pins
- Punctures & holds paper signs up to .012" thick in flush position
- 1/2" wide hinged strap
- Fits wire diameters up to .375"
- Polypropylene material
- Packaged 250 per bag



ITEM #	HEIGHT OF LABEL AREA	WIDTH OF LABEL AREA	COLOR
107208	3/4"	1-1/2"	Natural

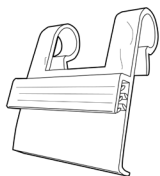

Notched Gripper Wire Flush Sign Holder

Gripper fins hold securely for hanging of signs in flush position from wire fixtures, baskets, edging, etc. Clips easily for swinging mount over wire. Removable and reusable.

- 1-3/4" overall height
- 1-3/8" wide holder has one notch and two hooks
- 2-1/2" wide holder has two notches and three hooks
- Fits wire diameter up to .375"
- Holds signs up to .080" thick
- Clear PVC material



ITEM #	OVERALL WIDTH
108676	1-3/8"
108677	2-1/2"

Notched Gripper Wire Flag Sign Holder

Gripper fins hold securely for hanging of signs in vertical (flag) position from wire fixtures, baskets, edging, etc. Clips easily over wire. Part is removable and reusable.

- 2-1/4" overall length x 1" wide x 9/16" height
- Fits wire diameters up to .375"
- Holds signs up to .080" thick
- Clear PVC material

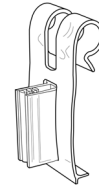

ITEM #	SIGN POSITION
108105	Flag

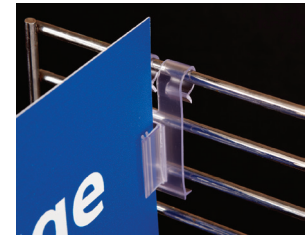

Gripper Wire Flag Sign Holder

Clip-on design, coupled with gripper ribs, firmly attach to wire to prevent sign from rotating on wire thus allowing for a variety of viewing angles. Two common wire diameters to choose from. Great for use on wire fixtures, baskets or edging.

- 1 1/16" height
- Fits .200" or .250" diameter wire
- Holds signs up to .080" thick
- Custom lengths available
- Clear PVC material

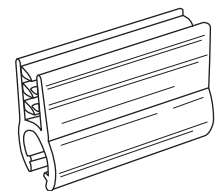

ITEM #	WIRE DIAMETER CAPACITY	LENGTH
108521	.200"	1"
108665	.250"	1"

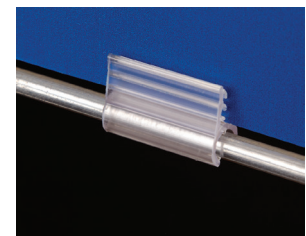

Gripper Wire Flush Sign Holder

Gripper fins hold securely for hanging of signs in flush position from wire fixtures, baskets, edging, etc. Clips easily over wire. Use two or more pieces for larger signs.

- 7/8" height
- Fits wire diameters up to .375"
- Holds signs up to .080" thick
- Custom lengths available
- Clear PVC material



ITEM #	LENGTH
108522	1/2"
108529	1"

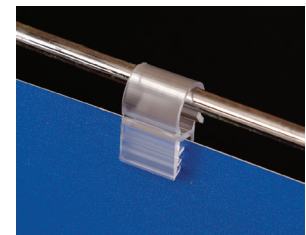

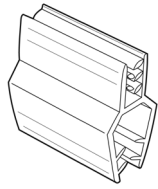

Gripper "H" Clip

Mount signs to other signs, panels or wire fixtures. Gripper fins hold securely. Can be used in either vertical (flag) or horizontal position. Use two or more pieces for larger signs.

- Two profiles to choose from
- Custom lengths available
- Clear PVC material

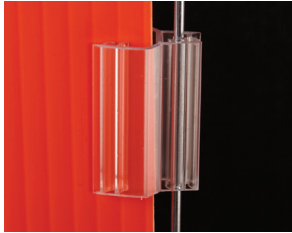

ITEM #	GRIP CAPACITY SIDE 1	GRIP CAPACITY SIDE 2	OVERALL HEIGHT	LENGTH
108609	up to .080"	.125" to .187"	1"	1"
108610	up to .080"	.125" to .187"	1"	1-1/2"
NEW 140901	.125" to .187"	.187" to .312"	1.175"	3"

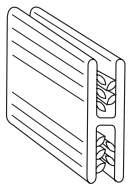

Gripper "H" Sign Holder

Gripper fins hold securely for mounting of signs above displays, other signs or to wire fixtures. Can be used in either vertical (flag) or horizontal position. Use two or more pieces for larger signs.

- 3/4" height
- Each side fits up to .080" diameter wire or holds signs up to .080" thick
- Custom lengths available
- Clear PVC material

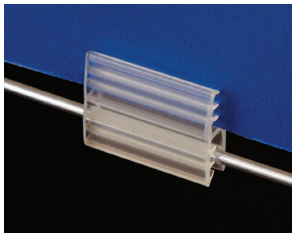

ITEM #	LENGTH
108518	1"
108519	3"

Sign & Literature Holders

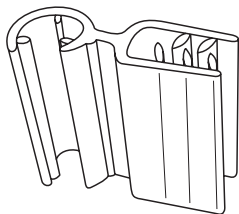

Gripper Hinged Flag Sign Holder For Wire

Clip-on design, coupled with gripper ribs, firmly attach to wire to prevent sign from rotating on wire, thus allowing for a variety of viewing angles. Gripper fins hold securely for mounting of signs. Flexible hinge swings and returns to original position when bumped.

- 7/8" height
- Holds signs up to .080" thick
- Custom lengths available
- Clear PVC material

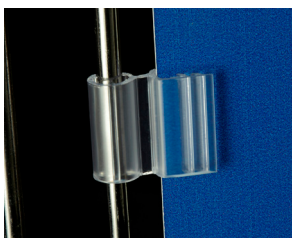

ITEM #	WIRE DIAMETER CAPACITY	LENGTH
108719	.150" to .165"	3/4"

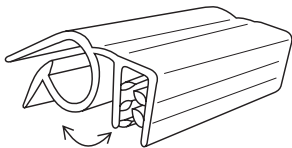

Gripper Hinged Flush Sign Holder For Wire

Oversized clip-on design that is perfect for attaching to wires up to .375" diameter as well as bins, bowls, pans and deli trays. Gripper fins hold securely for mounting of signs. Flexible hinge allows sign to flip up and return to original position.

- 1-3/8" overall width
- Holds signs up to .080" thick
- Custom lengths available
- Clear PVC material



ITEM #	WIRE DIAMETER CAPACITY	LENGTH
108897	up to .375"	1-1/2"

Adhesive Wire Grid Sign Holder

NEW

Display signs on common wire grid fixtures for increased visibility, using the peel-and-stick foam tape adhesive. Great for use on most standard power wing fixtures. Double clip-on design firmly attaches to wires and prevents rotation.

- Fits 1" wire grid fixtures up to 0.188" diameter
- Peel-and-stick adhesive area is 2" tall
- 1-1/4" wide
- Custom widths available
- Clear PVC material

ITEM #	OVERALL HEIGHT
140896	2-1/8"

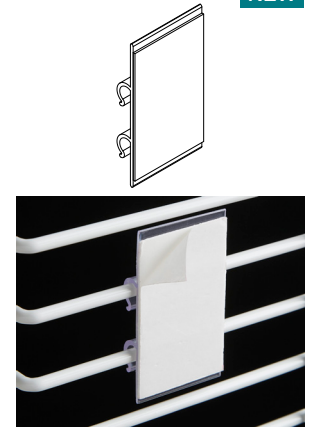

"J" Hook Wire Sign Holder

Hook over wire with the adhesive side used to hold signs, lightweight displays or literature holders. Adheres to any clean, flat surface. Can also be used with corrugated displays.

- 1" wide x 3/4" face height
- 3/4" wide adhesive backing
- Custom lengths and colors available
- White styrene material

ITEM #	MAX. WIRE DIAMETER
108562	up to 5/16"

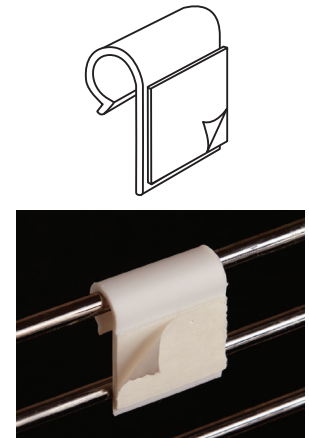

R-Clip With Adhesive

NEW

An improved version of our All Purpose Adhesive Clip, now with five gripping "teeth" to help keep signs in place. Sign materials slide in for firm grip. Adheres to any clean, flat surface or can be snapped over wire, using the adhesive side to hold signs, lightweight displays or literature holders.

- 1" wide adhesive back (white foam tape)
- Custom lengths also available
- Clear PVC material

ITEM #	HEIGHT	MAX. GRIP CAPACITY	MAX. WIRE DIAMETER
140857	1"	.200"	.300"

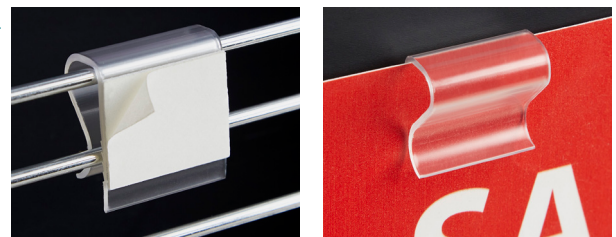

All Purpose Adhesive Clip

Sign materials easily slide into clip for firm grip. Adheres to any clean, flat surface or can be snapped over wire with the adhesive side used to hold signs, lightweight displays or literature holders.

- Both sizes have 1" wide adhesive backs
- Custom lengths also available
- White styrene material

ITEM #	I.D.	HEIGHT	MAX. MATERIAL CAPACITY	MAX. WIRE DIAMETER
108506	.180"	.844"	.125"	.180"
108505	.300"	1.000"	.187"	.300"

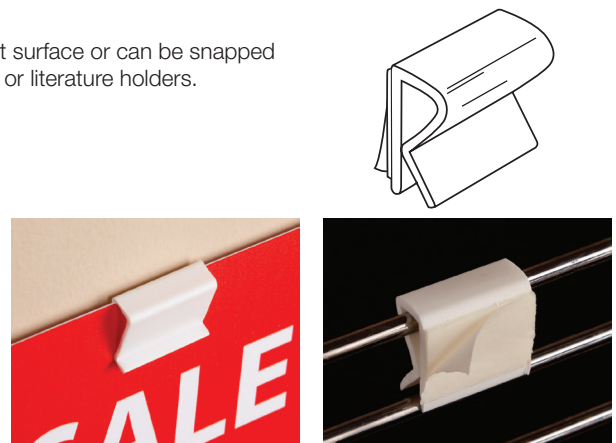



Adhesive Wire/Pen Clip

Snap over wire to attach signs with adhesive or use to hold pens/pencils to any clean, flat surface. Simply peel and stick for a secure hold.

- Fits up to .313" diameter wire, pens or pencils
- White polypropylene material
- Packaged 250 per bag

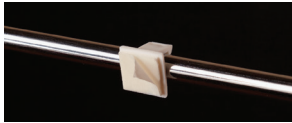
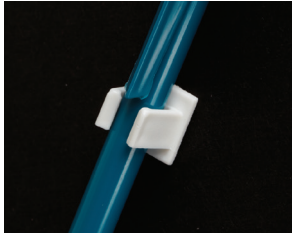

ITEM #	BASE DIMENSIONS	OVERALL HEIGHT
108501	1/2" x 1/2"	7/16"

Sign & Literature Holders



Swiveling Clever Clip

Strong spring clip that holds just about anything. Split ring top design allows for easy hanging from rods, hooks, wires or suction cups. Both ends swivel and rotate in opposite directions.

- 5/16" wide spring clip joined to a split ring top
- Spring clip has a strong maximum grip capacity of 3/16"
- Split ring top fits up to 3/8" diameter wire fixtures
- Polypropylene material
- Packaged 100 per bag



ITEM #	OVERALL LENGTH	COLOR
150325	1-7/8"	White
150325B	1-7/8"	Black

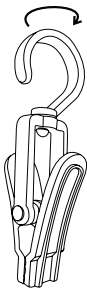

Swiveling Clever Clip – Jumbo

Strong, heavy duty oversized spring clip that securely holds just about anything. Open hook top design allows for hanging from plastic chain, rods, pipes or large diameter fixtures. Both ends swivel and rotate in opposite directions.

- 3/4" wide spring clip joined to an open hook top
- Spring clip has a strong maximum grip capacity of 5/8"
- Open hook top fits up to 1/2" diameter fixtures
- Other colors also available – please inquire
- HIPS material
- Packaged 100 per bag



ITEM #	OVERALL LENGTH	COLOR
150326	4-1/2"	White

Track Sign Holders With Ratcheting Heads

Various bases hold our full line of single-track or multi-track sign channels, ideal for grocery stores and produce sections. These sturdy bases have ratcheting heads, allowing signage to tilt to optimal viewing angles. Kinter can cut our track sign channels (sold separately – see page 38) to custom lengths to connect to these bases - please call for details.

- Unlimited creativity to combine promotional and pricing information
- #150409B features a 3" dia. heavy-duty magnetic base, with a stem that adjusts between 6" and 11" in height using an integrated thumb screw
- #150412B features a 3" wide x 11" long angled / sloping base for refrigerator cases, with a stem that adjusts between 6" and 11" in height using an integrated thumb screw
- #150413B features a shovel base that fits over table edges (1.350" maximum thickness) with a stem that adjusts between 6" and 11" in height using an integrated thumb screw
- #150414B features a 4" x 3-1/2" flat base, with a stem that adjusts between 6" and 11" in height using an integrated thumb screw
- #150420B features a "hitchhiker" thumb clamp that grips various objects up to 1-1/2" thick, with an overall height of 6" and a fixed stem that rotates 360 degrees
- Custom track channels and custom colors available
- Black steel and black plastic material

ITEM #	BASE STYLE	FOR USE ON	HEIGHT	MATERIAL	COLOR
150409B	Magnetic / Circular	Metal Surfaces	7" through 11"	Steel	Black
150412B	Sloping / Elongated	Refrigerator Cases	7" through 11"	Steel	Black
150413B	Shovel Base / Side Clamp	Table Edges	7" through 11"	Steel	Black
150414B	Plain / Rectangular	Flat Surfaces	7" through 11"	Steel	Black
150420B	Rotating Thumb Clamp	Various Objects	6"	Plastic	Black

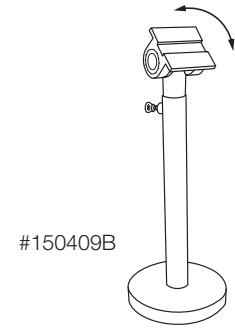

#150409B

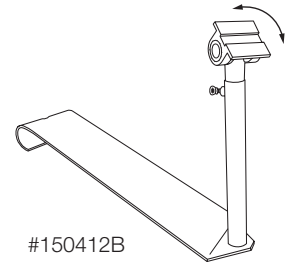

#150412B

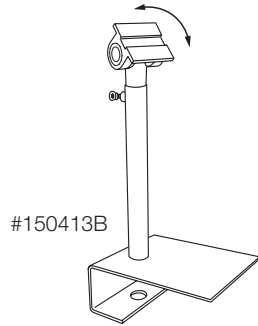

#150413B

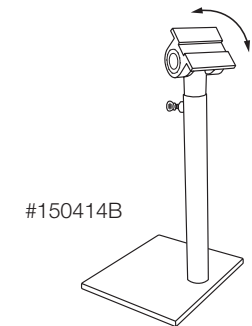

#150414B

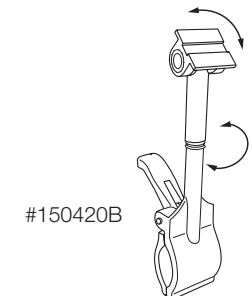

#150420B



#150409B



#150412B



#150413B



#150414B



#150420B

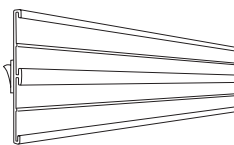

Track Sign Channels
sold separately (see page 38)



Close-up of
ratcheting head

Produce Bin Overhanging Sign Frame

Hang signs off the edge of produce bins, wooden crates or similar objects with these simple overhanging metal sign frames. Durable, one-piece design features welded "L" bracket or brackets that slip over bin edges. Signage slides into pre-formed tracks.

- Each size includes at least one 5/32" hole for optional permanent mounting
- Accepts signs up to .050" thick
- Custom sizes and colors/finishes available - please inquire
- Black painted steel material

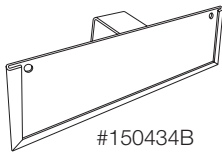

#150434B

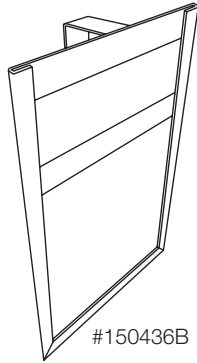

#150436B

ITEM #	FRAME HEIGHT	FRAME WIDTH	FITS EDGE	# OF BRACKETS	FINISH
150434B	2-1/2"	7"	1" Thick	1	Painted Black
150435B	2-1/2"	7"	1-3/8" Thick	1	Painted Black
150436B	11"	7"	1-1/2" Thick	1	Painted Black
150418B	14"	11"	3/8" Thick	2	Painted Black



#150434B



#150436B

Sign & Literature Holders

Bucket Clip Track Sign Holder

Display signs on floral or produce buckets. Two-track sign holder clips over common buckets or pails and holds signs upward for improved visibility. Channel tracks display 1-1/4" height signs, or 2-1/2" height signs when spread across both tracks. Includes a friction-fit slot that runs along the top edge for additional signage to rise above.

- Combine promotional and pricing information
- Each track accepts 1-1/4" height signs; 2-1/2" height signs when spread over both tracks
- Custom lengths, custom tracks and custom colors available
- Black PVC material

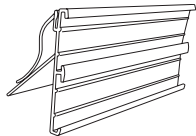

ITEM #	STYLE	LENGTH	OVERALL HEIGHT	COLOR
140749B	2-Track	4"	2-5/8"	Black

BetterView Ratcheting Sign Holders

Durable, clip-on sign holders compatible with various adapters in our BetterView sign system (adapters sold separately). Neatly hold and protect signs or pricing information. Ratcheting design allows signs to be displayed at ideal angle for the perfect view. Removable and reusable.

- Signs ratchet up and down for optimal viewing
- 40 mil thick
- Other sizes available - please inquire
- Clear plastic material

ITEM #	HEIGHT	LENGTH
140660	3-1/2"	5-1/2"
140718	1-1/4"	3"

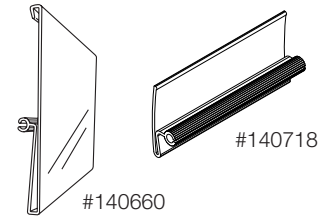

Shovel base sold separately

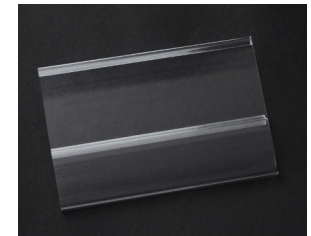

BetterView Shovel Base Adapters

Simple shovel base compatible with our line of BetterView Ratcheting Sign Holders (sold separately). Shovel base slips under boxes or products. Ratcheting design allows sign to be displayed in ideal position for the perfect view. Removable and reusable.

- BetterView Ratcheting Sign Holders snap in and adjust to optimal angle – sold separately
- Two base styles to choose from
- Best when slid underneath something
- 1/16" thick, clear PVC material

ITEM #	STYLE	HEIGHT	WIDTH	BASE DEPTH
140659	Straight	4"	2"	2-1/2"
NEW 140771	Angled	2"	3"	3"



Sign holder sold separately

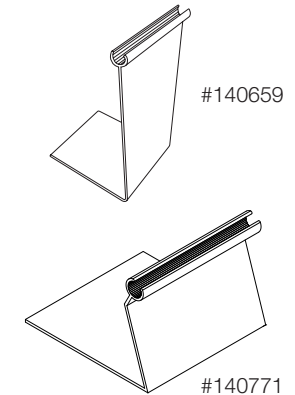

BetterView Adapter For Shelf Channel

Durable, clip-on adapter for common 1-1/4" height shelf channels, compatible with our line of BetterView Ratcheting Sign Holders (sold separately – see above). Ratcheting design allows sign to be displayed in ideal position for the perfect view. Removable and reusable.

- Snaps into standard 1-1/4" height shelf channels
- Mating sign ratchets up and down for optimal viewing
- Clear butyrate material

ITEM #	LENGTH	COLOR
140700	2"	Clear

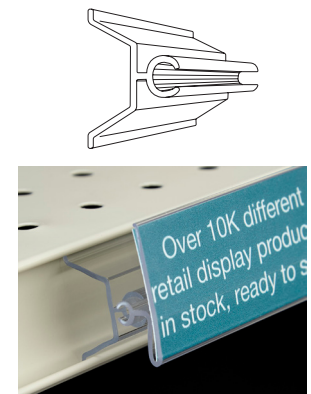

Sign holder sold separately

BetterView Adapter For Wire & Corrugated

Durable, clip-on adapter for wire or corrugated products, compatible with our line of BetterView Ratcheting Sign Holders (sold separately – see above). Ratcheting design allows sign to be displayed in ideal position for the perfect view. Removable and reusable.

- Fits over material .188" to .375" diameter
- Mating sign ratchets up and down for optimal viewing
- Clear butyrate material

ITEM #	LENGTH	COLOR
140620	2"	Clear



Sign holder sold separately

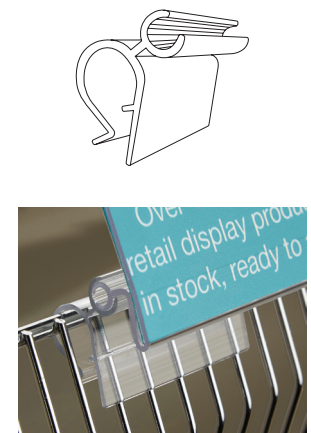

Sign holder sold separately

Spring Clip-On Track Sign Holder

One-track or two-track sign holder is supported by a durable spring clip, allowing attachment to multiple fixtures. Clip is lined with anti-slip coating and securely grips thicker items. Knuckling swivel system allows for display at optimal angles. Friction-fit slots support additional signage (details below).

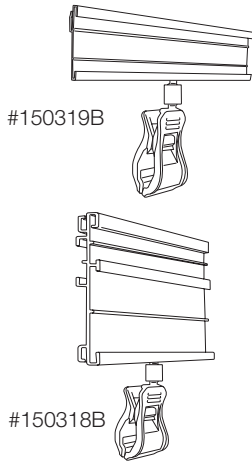

- Combine promotional and pricing information
- #150319B features one track that accepts 1-1/4" height signs, with a friction-fit slot on top for additional signage to rise above
- #150318B features two tracks that accept 1-1/4" and 2-1/4" height signs, with friction-fit slots on the top and bottom for additional signage to rise above or hang below
- Spring clip has a maximum grip of 1" dia.
- Custom lengths, custom tracks and custom colors available
- Black plastic and black PVC material

ITEM #	STYLE	TRACK HEIGHT	BONUS SLOT	LENGTH	OVERALL HEIGHT	COLOR
150319B	1-Track	1-1/4"	Top	5-1/4"	4-1/4"	Black
150318B	2-Track	1-1/4" and 2-1/4"	Top & Bottom	5-1/2"	6-3/4"	Black



Ratchet-Style Deli Sign Clip

Top and bottom sections combine to form an ingenious ratcheting clip that is ideal for displaying signs, labels or advertisements on bowls, pans, floral buckets or other goods. Also works on deli style trays that have lipped edges. Two-way ratcheting ribs both securely hold and tilt signs forward or backward for optimal viewing angles. Removable and reusable.

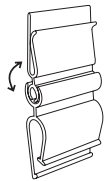

- Two clips joined by a firm interlocking ratcheting design
- Top end holds signs up to .080" thick
- Other end hooks onto goods up to 3/8" thick
- Clear PVC material
- Parts come unassembled
- Packaged 25 tops and 25 bottoms per bag

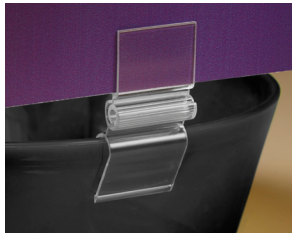

ITEM #	WIDTH	OVERALL ASSEMBLED HEIGHT
108900	1"	2-1/4"

Gourmet Clip Tag Holder

Popular friction fit clip that is ideal for displaying signs, labels or advertisements on bowls, trays or pans. Removable and reusable.



- One end holds signs up to .030" thick
- Other end clips onto solid bowl edges or pan lip edges up to 3/8"
- Clear PVC material



ITEM #	WIDTH	OVERALL LENGTH
108844	1"	1-3/4"

Multi-Purpose Sign Holder

Display signs high and low on most bowls, trays or pans, or other objects up to 1/2" thick. Dual sign holders friction-fit for a secure grip. Removable and reusable.

- Clips hold signs up to .030"
- Base fits objects up to 1/2" thick
- Other lengths and colors available – please inquire
- Clear plastic material

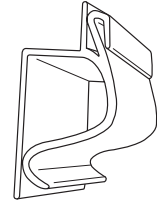

ITEM #	WIDTH	OVERALL LENGTH
109564	1-1/4"	1-1/4"

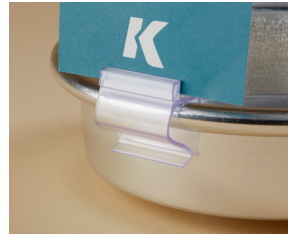

Two-Way Sign Clip

A solid, economical tension grip clip that is ideal for displaying signs, labels or advertisements on bowls, pans, floral buckets or other goods. Adjusts to a wide degree of viewing angles. Wider and stronger than our Shoe Clip Sign Holder. Removable and reusable.

- One end holds signs up to .040" thick
- Other end clips onto goods up to .430" thick
- Crystal clear provista material

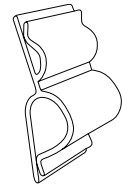

ITEM #	WIDTH	OVERALL LENGTH
108737	3/4"	1-1/2"

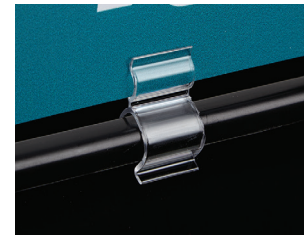

Stainless Steel Pan Clip

Multi-purpose, stainless steel holder that is perfect for displaying signs, labels or advertisements in misted environments or in hot and/or cold food cases. Ideally designed as a clip-on tag or sign holder on the lipped edges of trays, bowls and stainless steel pans. Integrated holes with varying ranges of diameters, offering added sign or display mounting options via pop rivets or threaded fasteners. Secure angled design for enhanced visibility.

- One end holds sign materials up to .030" thick
- Other end clips onto solid bowl edges or serving pan lip edges of 3/8" to 9/16"
- Stainless steel material
- Packaged 12 per bag
- Sold in full bags only

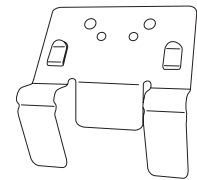

ITEM #	WIDTH	HEIGHT
150224	2-3/8"	2-3/8"



Shoe Clip Sign Holder

Extremely economical clip that is ideal for displaying signs, labels or advertisements on shoes or other goods. Adjusts to a wide degree of viewing angles. For a stronger hold, use our Two-Way Sign Clip #108737 (see above). Removable and reusable.

- One end holds signs up to .080" thick
- Other end clips onto shoes or other goods up to .375" thick
- Clear butyrate material



ITEM #	WIDTH	OVERALL LENGTH
107106	3/8"	1-1/2"



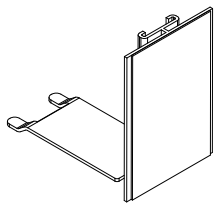

Upward Shelf-Top Adhesive Sign Holder – Metal

Display various signs above standard perforated shelves. Unlike Kinter's other shelf-top sign holders, this product is designed to rise above the shelf rather than hanging below. Simply peel and stick your message to the 2" x 3" adhesive face. Use two or more holders for larger signs.

- Signs stand above the shelf
- Slide-on face is made from clear PVC with peel-off foam adhesive
- Base is made of beige painted steel material



ITEM #	STYLE	FACE SIZE	COLOR
106450	Adhesive Face	2" Wide x 3" Height	Beige



Flush Mount Adapter With Adhesive

Use this adapter to mount signs, pockets or literature holders practically anywhere. Adapter is sold either by itself or attached onto one of several different metal or plastic bases (see pages 108-112) for easy placement of your graphic in almost any retail setting – please inquire.

- 2" wide x 3" tall front mounting area
- Front mounting area has permanent foam tape with peel & stick paper backing
- Also available with four .187" diameter mounting holes instead of foam tape – please inquire
- Clear PVC material



ITEM #	MOUNTING AREA WIDTH	MOUNTING AREA HEIGHT	STYLE
118729	2"	3"	Without Base



Order pre-assembled (please inquire)



Hinged Gripper Offset Sign Holder

Gripper sign holder that attaches to the top or sides of any clean, flat surface such as shelves and pallet rack uprights and cross members. Easily attach pricing or product information offset and extended into the aisle in horizontal (flush) position. Built-in hinge function flips the sign up when stocking shelves below.

- 1-1/2" long adhesive backed shelf attachment strip
- Gripper fins hold signs firmly up to .080" thick
- Extends 3/4" out from shelf edge
- Custom lengths and colors available
- Clear PVC material

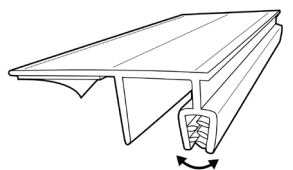

ITEM #	LENGTH	WIDTH	HEIGHT
108530	5-1/2"	2-1/4"	3/4"

Universal Adjustable Flush Grippers

This **Patented** design is universal, interchangeable and inexpensive. Add flush mounted signs and displays to most square edged gondola end caps, uprights, cross members, wing panels or any other (metal or wood) retail or warehouse fixture. One clip does it all. Built-in ratcheting settings allow for fine adjustments; thus, undersized or oversized store fixtures are never a problem. Gripper fins hold signs securely with no adhesive or fasteners required. Each clip is produced and shipped as one piece and is eco-friendly since it is removable and reusable.

How it works: Simply snap apart the attached break-away leg, engage leg at desired width, micro-adjust and press onto fixture.

- Retail style has 1" tall fixture gripper legs and a pre-breakaway width of 3-1/2"
- Warehouse style has 1-1/4" tall fixture gripper legs and a pre-breakaway width of 3-7/8"
- Warehouse style will also fit round fixtures up to 1-1/2" in diameter
- Custom lengths available
- Clear PVC material

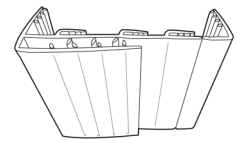

for Retail Environments

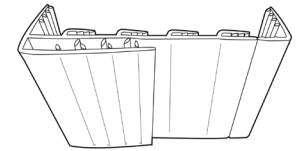

for Warehouse Environments

ITEM #	ENVIRONMENT	LENGTH	SIGN GRIP CAPACITY	SIGN GRIP ARM DEPTH	# OF FIXTURE SETTINGS	FIXTURE GRIP CAPACITY
108640	Retail	3"	up to .100"	3/4"	3	1" to 2-3/4"
108641	Retail	6"	up to .100"	3/4"	3	1" to 2-3/4"
108623	Retail	3"	.100" to .187"	2"	3	1" to 2-3/4"
108624	Retail	6"	.100" to .187"	2"	3	1" to 2-3/4"
108642	Warehouse	3"	up to .100"	3/4"	4	5/8" to 3-1/4"
108643	Warehouse	6"	up to .100"	3/4"	4	5/8" to 3-1/4"
108635	Warehouse	3"	.100" to .187"	2"	4	5/8" to 3-1/4"
108636	Warehouse	6"	.100" to .187"	2"	4	5/8" to 3-1/4"

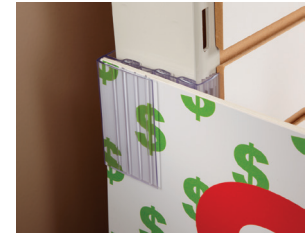
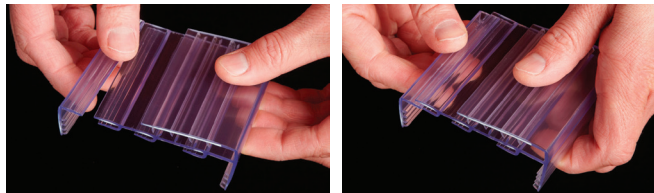

Perpendicular Gripper Sign Holder

NEW

Attach signs across open freezer cases or display cases using this perpendicular sign holder with dual grippers, fused together on a high-impact plastic base. Features a heavy-duty bottom gripper and a second gripper on top to hold graphics. Use two units on either side of freezer/display cases to support larger blade signs.

- Bottom gripper has a capacity of .625" to .750"
- Sign gripper has a capacity of .187" to .250"
- Grippers are clear PVC
- Connecting base is clear polycarbonate

ITEM #	HEIGHT	LENGTH	COLOR
106230	2-3/8"	4"	Clear

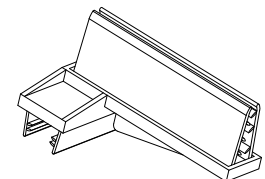

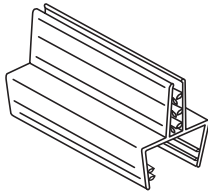

Gripper Square Edge Sign Holder

Add signage vertically or horizontally to metal or wood square edged fixtures. Use two pieces to hold larger graphics or blade signs. Gripper fins hold signs securely. Available in two edge capacity grip ranges – narrow base or wide base.

- Both sizes are 1-5/8" overall height and have 7/8" tall gripper fin section
- The narrow base capacity part has a 3/4" wide base
- The wide base capacity part has a 1" wide base
- Clear PVC material

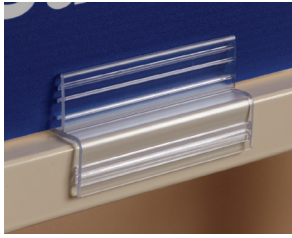

ITEM #	LENGTH	BASE CAPACITY	GRIP CAPACITY
108563	3"	.625" to .750"	up to .125"
108564	3"	.875" to 1.000"	up to .125"

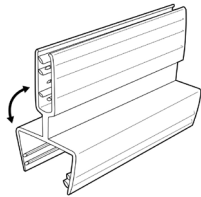

Hinged Gripper Square Edge Sign Holder

Great for mounting signs in high traffic areas. Flexible hinge swings and returns to original position when bumped. Add signage vertically or horizontally to metal or wood square edged fixtures.

- 2" overall height
- Integrated flexible hinge joins 7/8" tall gripper to a 1" wide base
- Custom lengths available
- Clear PVC material

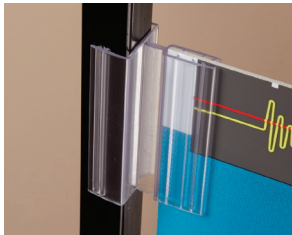

ITEM #	LENGTH	BASE CAPACITY	GRIP CAPACITY
108582	3"	.875" to 1.000"	up to .125"

Sign & Literature Holders

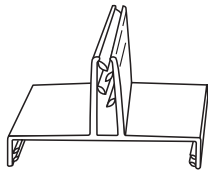

Gondola Top Gripper Sign Holder

Great for mounting signs on top of gondolas without the need for adhesive. Base has gripper fins that attach securely onto the top of standard retail gondolas. Removable and easy to relocate. Soft gripper fins allow for easy sign insertion and holds signs firmly in place.

- 1" height
- Custom lengths available
- Clear PVC material



ITEM #	LENGTH	BASE CAPACITY	GRIP CAPACITY
108555	3"	2-3/4"	.187" to .250"
108556	6"	2-3/4"	.187" to .250"

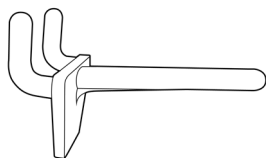

Instant Flag Slatwall/Pegboard Display Base

When used in conjunction with our line of instant flag display tubes (sold separately), this base holds signs securely in either slatwall or pegboard in a perpendicular position. Simply hook into pegboard holes or slatwall.

- Stem is designed for use with instant flag display tubes
- Fits standard 1/4" diameter pegboard holes (1" on center) or slatwall
- ABS material



ITEM #	STEM LENGTH	STYLE
107110	2"	2 Prongs



Instant Flag Angled Display Base

When used in conjunction with our line of instant flag display tubes (sold separately), this base holds signs at 30 degree upward angles. The base without adhesive snaps into standard 1-1/4" shelf price channels and holds securely. The base with adhesive sticks to any clean, flat surface or can be pressed into shelf price channels for extra strength.

- Stem is designed for use with instant flag display tubes
- Base is 1.200" square, with or without adhesive
- Fits 1-1/4" shelf price channels
- Base with adhesive sticks to any clean, flat surface
- White polypropylene material

ITEM #	STEM LENGTH	STYLE
107111	1-1/2"	No Adhesive
107112	1-1/2"	With Adhesive

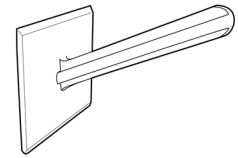

#107112 can also be used with our Magnetic Adapter (sold separately – see page 216).

Instant Flag Gripper Display Tube

Quickly hang ever-changing advertisements in eye-catching flag position with little effort or cost. Featuring integrated gripper fins that slide over edging of signs for a secure hold. Use in conjunction with any Instant Flag Display Base (sold separately). Removable and reusable.

- Holds lightweight signs up to 1/8" thick
- 13/32" height oval shaped pinched gripper edging
- Various display base options (sold separately)
- Available in custom lengths and colors
- White PVC material

ITEM #	LENGTH	COLOR
110027	12"	White
110028	24"	White

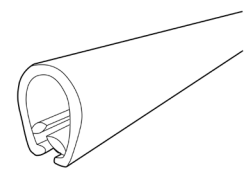

Instant Flag Slitted Display Tube

Quickly hang ever-changing advertisements in eye-catching flag position with little effort or cost. Slides directly onto edge of lightweight signs and holds securely. Use in conjunction with any Instant Flag Display Base (sold separately). Removable and reusable.

- Holds lightweight signs up to 1/8" thick
- 3/8" height oval shaped pinched edging
- Various display base options (sold separately)
- Available in custom lengths and colors
- White styrene material

ITEM #	LENGTH	COLOR
110050	12"	White
110051	24"	White

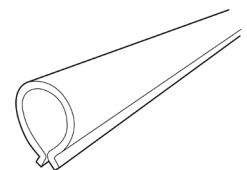



Shown with #107703B (sold separately)

Aisle Sign Arm Hanger – Arched

For use in conjunction with either our two-way adapter #107701 or our three-way universal adapter #107700B (both sold separately) for pegboard, slatwall and metal surfaces. Use to hang and display signs, promotions or category markers in flag position. Easy double-hook back plate change out for emphasizing categories or store messaging. Removable and reusable.

- 17" overall extended length – arched shaped design
- .125" diameter wire with two horizontal bar-attached .125" diameter open hooks
- Recommended minimum sign hole size is .203" at 4" on center
- Other shapes, styles and colors available – please inquire
- Steel powder coated black

ITEM #	OVERALL HEIGHT	OVERALL EXTENDED LENGTH	STYLE	COLOR
107713B	6"	17"	Arched	Black

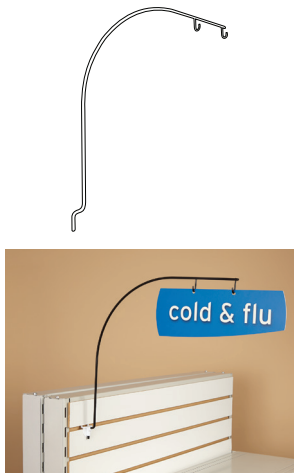

Adapter sold separately

Aisle Sign Arm Hanger – Curved

For use in conjunction with either our two way adapter #107701 or our three way universal adapter #107700B (both sold separately) for pegboard, slatwall and metal surfaces. Use to hang and display signs, promotions or category markers in flag position. Easy double hook back plate change out for emphasizing categories or store messaging. Removable and reusable.

- 16" height x 16" extended length – curved shape design
- .125" diameter wire with two attached .125" diameter open hooks
- Recommended minimum sign hole size is .203" at 4" on center
- Other shapes, styles and colors available – please inquire
- Steel powder coated black

ITEM #	OVERALL HEIGHT	OVERALL EXTENDED LENGTH	STYLE	COLOR
107711B	16"	16"	Curved	Black

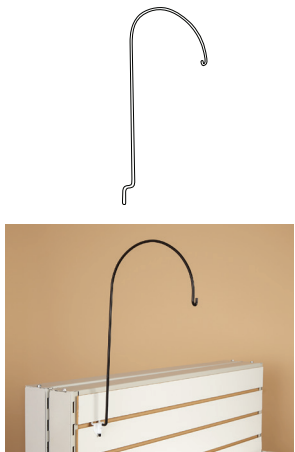

Adapter sold separately

Aisle Sign Arm Hanger – Shepherd

For use in conjunction with either our two way adapter #107701 or our three way universal adapter #107700B (both sold separately) for pegboard, slatwall and metal surfaces. Use to hang and display signs, promotions or category markers in flag position. Easy double hook back plate change out for emphasizing categories or store messaging. Removable and reusable.

- 17" height x 9" extended length – shepherd shape design
- .125" diameter wire with a single flag position open end hook
- Recommended minimum sign hole size is .281"
- Other shapes, styles and colors available – please inquire
- Steel powder coated black

ITEM #	OVERALL HEIGHT	OVERALL EXTENDED LENGTH	STYLE	COLOR
107712B	17"	9"	Shepherd	Black



Channel-Mount Arm Hanger – Curved

Hang signs or category markers with this compact aisle sign arm. No separate adapter needed - attached stainless steel clip firmly snaps into common "C" channel shelving fronts. Tilt arm to desired angle by releasing and tightening the integrated wing nut.

- 12" height x 5" extended length – curved shape design
- .160" diameter wire with a single open end hook (flag position)
- Recommended minimum sign hole size is .230"
- Other shapes, styles and colors available – please inquire
- Steel powder coated white

ITEM #	OVERALL HEIGHT	OVERALL EXTENDED LENGTH	STYLE	COLOR
107714W	12"	5"	Curved	White

Aisle Sign Arm Hanger – Straight

For use in conjunction with either our two way adapter #107701 or our three way universal adapter #107700B (both sold separately) for pegboard, slatwall and metal surfaces. Use to hang and display signs, promotions or category markers in flag position. Easy double hook back plate change out for emphasizing categories or store messaging. Removable and reusable.

- 16" overall extended length – straight shape design
- .212" diameter wire with two attached .212" diameter open hooks
- Recommended minimum sign hole size is .281" at 4" on center
- Other shapes, styles and colors available – please inquire
- Steel powder coated black

ITEM #	OVERALL EXTENDED LENGTH	STYLE	COLOR
107710B	16"	Straight	Black



Adapter sold separately

Aisle Sign Arm Hanger – Adjustable Hook

For use in conjunction with either our two way adapter #107701 or our three way universal adapter #107700B (both sold separately) for pegboard, slatwall, and metal surfaces. Use to hang and display signs, promotions or category markers in flag position. Easy double hook back plate change out for emphasizing categories or store messaging. Removable and reusable.

- 16" overall length - adjustable hook design
- .212" diameter wire with fixed hook end and a crimped "S" hook that slides independently along the bar for hanging various sign sizes
- Other shapes, styles and colors available – please inquire
- Steel powder coated black
- One arm and one crimped "S" hook per bag

ITEM #	OVERALL EXTENDED LENGTH	STYLE	COLOR
107718B	16"	Adjustable Hook	Black

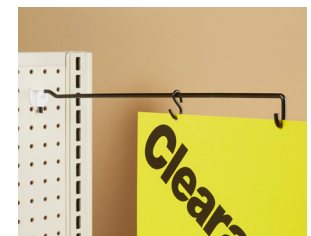
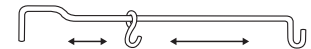

Adapter sold separately

Magnetic Adjustable Double-Hook Aisle Sign Arm

Hold aisle signs securely in flag position from almost any angle off exposed metal surfaces such as the underside of shelving fixtures or tops of gondolas. Ratcheting magnetic base design allows the display of signs, promotions or category markers at optimal viewing positions with the simple push of a side button. Adjustable double clear plastic hooks rotate and fit a wide range of hole placement widths of up to 10 inches apart. Removable and reusable. **Warning:** Magnets should not be used near electronic equipment.

- Stem style is fixed length and is not telescopic
- Includes a plastic tip safety end cap – gray
- .120" clear plastic hook diameter
- 90 degree bent arm is 12" long x 3-1/2" height x 3/8" diameter
- Minimum recommended sign hole size is 3/16"
- Magnetic base is 1-1/2" wide x 2-3/4" long x 5/8" height
- Brushed aluminum arm with white plastic base
- Other colors, arm directions or arm heights/lengths available – please inquire

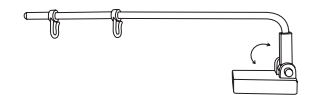

ITEM #	HOLE PLACEMENT	SIGN THICKNESS
106890	1" to 10" Width	up to 1/4" Thick

Garment Display Hanger

An inexpensive, clever way to display varieties of garments for any occasion, message or season. When combined with our Double Magnetic Adapter Base (sold separately – see page 153) and placed directly on exposed metal surfaces such as shelving fixtures or gondola tops, this ingenious hanger offers an attention-grabbing presentation. Create full 360 degree optimal viewing angles by simply swiveling the stem's direction within the Double Magnetic Adapter Base. Use one hanger for single-sided garment placement or two hangers back to back for double-sided impact. Removable and reusable.

- Curved tip top offers the ability to dual display hats as well
- .234" wire stem diameter
- Steel powder coated black
- Other colors or finishes also available – please inquire

ITEM #	OVERALL HEIGHT	HANGER WIDTH	COLOR
107716B	35"	18"	Black



Adapter sold separately

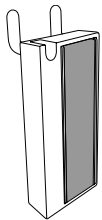

Universal Magnetic Adapter For Aisle Sign Arms

Ingenious flush mount magnetic adapter that can be used to place and support common wire aisle sign arms directly to pegboard, slatwall and metal surfaces – all with one back plate connector! Use to attach signs, promotions or category markers in flag position. Interchangeable with existing competitors' aisle sign arms or Kinter's (sold separately). Removable and reusable. Unlike existing plastic or metal backs that commonly accept one specific wire size, this tapered hole adapter is designed to accept a wide range of wire diameters. **Warning:** Metal conditions will affect holding power. Magnets should not be used near electronic equipment. **Patented.**



Aisle sign arms sold separately

- Works with common .186" through .234" wire diameters
- Fits standard 1/4" diameter pegboard holes and all standard slatwall grooves
- Two prongs at 1" on center and having 5/8" height
- Available in additional colors – please inquire
- Black polypropylene material

ITEM #	LENGTH	WIDTH	COLOR
107700B	3"	1-5/16"	Black

Use this adapter to mount your aisle sign arms just about anywhere:



Pegboard



Slatwall



Directly on metal

Sign & Literature Holders

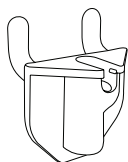

Pegboard/Slatwall Adapter For Aisle Sign Arms

Sturdy flush mount back plate connector that can be used to place and support common wire aisle sign arms directly into pegboard holes or slatwall. Use to attach signs, promotions or category markers in flag position. Works with existing .212" diameter competitors' aisle sign arms or Kinter's (sold separately). Removable and reusable.



- Easy to install and works with common .212" through .225" wire diameters
- Fits standard 1/4" diameter pegboard holes and all standard slatwall grooves
- Two prongs at 1" on center and having 5/8" height
- White delrin material
- Available in additional colors and diameter receptacles – please inquire
- Packaged 100 per bag

ITEM #	LENGTH	WIDTH	COLOR
107701	1-3/16"	1-5/16"	White



Pegboard



Slatwall

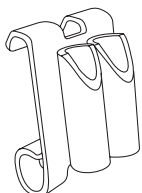

Metal Adapter For Crossbar & Wire Grids

Dual-purpose metal adapter that works on both wire grids and standard flat bar merchandising crossbar fixtures to place and support varying diameters of single-prong metal peg hooks or wire aisle sign arms. Spring-fit, curled back plate design is easy to attach and securely stays in place. Two different size tapered adapter tubes front welded together offering sturdy upright support. Removable and reusable.



- Friction fits standard 1" crossbars (AKA Wonder Cross Bars)
- Top notched backplate design also fits common 1" wire grids
- Works with common .187" through .234" wire stem diameters
- Backplate measures 1" wide x 1-1/2" height
- Zinc plated steel
- Packaged 50 per bag

ITEM #	OVERALL HEIGHT	WIDTH
107702	1-1/2"	1"

Double Magnetic Adapter Base For Aisle Sign Arms

Double your aisle signing impact. Use to place and support one or two Aisle Sign Arms or Garment Display Hangers simultaneously from top rails of gondolas or other metal surfaces. Use in conjunction with Aisle Sign Arms (sold separately) to dual-mount display signs, promotions or category markers in flag position. Strong, extra heavy duty magnetic base assures no tipping. Removable and reusable. **Warning:** Magnets should not be used near electronic equipment. **Patented.**

- Two tapered adapter tubes welded together for sturdy upright support
- Works with common .212" through .234" wire stem diameters
- 2" overall height x 1-1/2" wide x 3" long
- Each end has a slotted shaped hole measuring .202" wide x .355" long
- Available in different colors – please inquire
- Steel powder coated black

ITEM #	OVERALL LENGTH	OVERALL HEIGHT	COLOR
107703B	3"	2"	Black

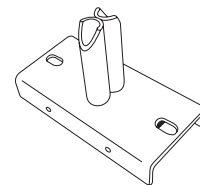

Aisle sign arms sold separately

Magnetic Flush-Style Adapter Base For Aisle Sign Arms

Increase your gondola endcap signage impact. Use to place and support aisle sign arms off gondola ends, pallet uprights or other metal surfaces. Use in conjunction with aisle sign arms (sold separately) to mount display signs, promotions or category markers. Strong, extra heavy duty magnetic base adapter. Removable and reusable. **Warning:** Magnets should not be used near electronic equipment. **Patent Pending.**

- Single tapered adapter tube flush welded for sturdy support
- Works with common .212" through .234" wire stem diameters
- 7/8" overall height x 1-1/2" wide x 3" long
- Each end has a slotted shaped hole measuring .202" wide x .355" long
- Also available as a two-way or three-way aisle sign holder – please inquire
- Also available in different colors – please inquire
- Steel powder coated black

ITEM #	OVERALL LENGTH	OVERALL HEIGHT	COLOR
109529B	3"	7/8"	Black

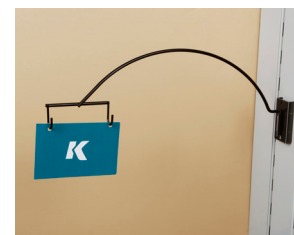
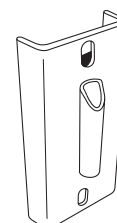

Aisle sign arms sold separately

Magnetic Sign Stand Adapter

Rectangular metal casing having a full three ceramic magnetic base for added strength. Centered, internally threaded female adapter bushing is great for receiving common externally threaded metal sign stems and rods. The perfect support adapter for larger upright signs or heavier displays. Removable and reusable. **Warning:** Holding capacity is the approximate maximum pull rating under ideal conditions. Always test suitability on per-application basis. For best results, use on an indoor, bare (unfinished) metal surface that is smooth and clean. Metal conditions will affect holding power. Magnets should not be used near electronic equipment.

- Available with optional non-scratch inserts (see page 216)
- 1/4" magnet base height x 7/8" wide x 3" long
- 3/8-24 NF internally threaded center bushing having 1/2" height x 1/2" O.D.
- 3/4" overall welded height
- Nickel plated steel housing and threaded receiver bushing

ITEM #	OVERALL LENGTH	HORIZONTAL CAPACITY
107087	3"	22 lbs.

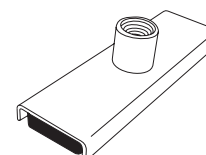

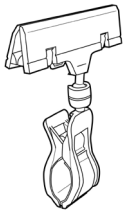

Spring Clip-On Knuckle Sign Holder

Large spring clip base is lined with anti-slip coating and securely attaches to fixtures. Heavy duty sign clip top is great for holding larger signs. Our durable pivoting swivel system allows for the display of signs and promotions at unique angles.

- Two clips joined by a swivel knuckle
- One end has a 1" wide spring clip with a maximum grip of 1-1/8" dia.
- Other end has a 3" wide heavy duty sign clip that can display material up to 1/4" thick
- Plastic material
- Packaged 25 per bag



ITEM #	OVERALL LENGTH	COLOR
150301	4"	Clear
150301B	4"	Black



Sign & Literature Holders

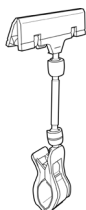

Spring Clip-On Extended Knuckle Sign Holder

Large spring clip base is lined with anti-slip coating and securely attaches to fixtures. Extended length heavy duty sign clip top is great for holding larger signs. Our durable pivoting swivel system allows for the display of signs and promotions at unique angles.

- 1-3/4" long center extender joining two clips via swivel knuckles
- One end has a 1" wide spring clip with a maximum grip of 1-1/8" dia.
- Other end has a 3" wide heavy duty sign clip that can display material up to 1/4" thick
- Plastic material
- Packaged 25 per bag



ITEM #	OVERALL LENGTH	COLOR
150302	6-1/4"	Clear
150302B	6-1/4"	Black

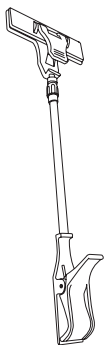

Heavy Duty Telescopic Clip-On Sign Holder

Large heavy duty spring clip base is lined with anti-slip coating and securely attaches to thicker fixtures quickly and easily. Extra wide sign clip top is great for holding larger signs. Sturdy, built-in telescopic stem extends and rotates 360 degrees to allow the display of signs and promotions at unique viewing angles. Removable and reusable.

- Two clips joined by a telescopic 7/16" diameter post
- One end has a 1-1/4" wide spring clip with a maximum grip of 2" thick
- Other end has a 4" wide x 1-1/4" height sign clip that can display material up to 1/2" thick
- Collapsed length is 17" with a maximum extended length of 24"
- Rotates only – does not knuckle or swivel
- Middle adjustable stem is white plastic
- Both clips are clear plastic, powered by metal springs



ITEM #	ADJUSTABLE STEM	COLOR
150315	17" to 24"	White & Clear

Spring Clip-On Rotating Thumb Sign Holder

Our most stable spring clip base sign holder that is lined with anti-slip white foam tape and offers an ingenious “easy pivot” thumb lever that makes attaching to store fixtures quick and simple. Extra wide sign clip top is great for holding larger signs. Durable rotating connector allows for 360 degree, full rotation viewing angles.

- Two clips friction joined by a solid 7/16" diameter post
- One end has a 1-3/8" wide spring clip with a maximum grip of 1-1/2" diameter
- Other end has a 4" wide sign clip that can display material up to 3/16" thick
- Rotates only – does not knuckle or swivel
- Other colors available – please inquire
- Black or white ABS material
- Packaged 10 per bag

ITEM #	OVERALL LENGTH	COLOR
150320	6"	White
150320B	6"	Black

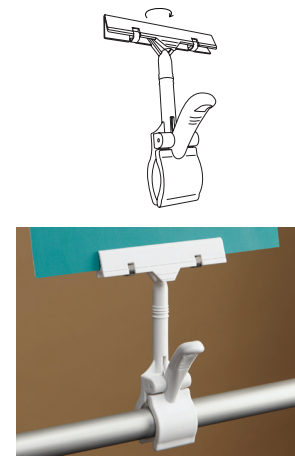

Spring Clip-On Two-Way Ratcheting Sign Holder

Large spring clip base is lined with anti-slip coating and securely attaches to fixtures. Heavy duty sign clip top is great for holding larger signs. Two-way ratcheting ribs both securely hold and tilt signs forward or backward for optimal viewing angles.

- Two clips joined by a firm interlocking ratcheting design
- One end has a 1" wide spring clip with a maximum grip of 1-1/8" dia.
- Other end has a 3" wide heavy duty sign clip that can display material up to 1/4" thick
- Clear plastic material
- Packaged 25 per bag

ITEM #	OVERALL LENGTH
150317	4"

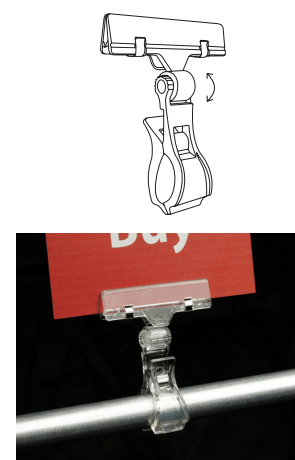

Clip-On Sign Protector

Large heavy duty spring clip base is lined with anti-slip coating and securely attaches to fixtures. Crystal clear sign cover top is great for displaying and protecting single or double sided signs. Our durable pivoting swivel system allows for the display of signs and promotions at unique angles.

- Clear sign protector joined to a spring clip via a white swivel knuckle
- One end has a 1" wide spring clip with a maximum grip of 1-1/8" dia.
- Other end has a clear sign protector that can display signs up to 1/32" thick, and is available in three sizes
- Clear plastic material
- Packaged one per bag

ITEM #	SIGN HEIGHT	SIGN WIDTH	OVERALL LENGTH
150314	2-1/2"	3-3/4"	5-3/4"
150311	3-1/2"	5-1/2"	6-3/4"
150312	5"	7"	8-1/4"





Clip-On Knuckle Sign Holder

Spring clip base securely attaches to fixtures or to other signs. Mini sign holder top is great for holding small size signs. Our durable pivoting swivel system allows for the display of signs and promotions at unique angles in any retail environment.

- Two clips joined by a swivel knuckle
- One end has a 3/4" wide spring clip with a maximum grip of 3/8" dia.
- Other end has a 1" wide x 5/8" height mini sign holder that can display material from .008" to .020" thick
- Plastic material
- Packaged 50 per bag



ITEM #	OVERALL LENGTH	COLOR
150303	2-3/4"	Clear
150303B	2-3/4"	Black

Sign & Literature Holders



Heavy Duty Clip-On Knuckle Sign Holder

Large heavy duty spring clip base is lined with anti-slip coating and securely attaches to thicker fixtures. Sign holder top is great for holding medium to small size signs. Our durable pivoting swivel system allows for the display of signs and promotions at unique angles.

- Two clips joined by a swivel knuckle
- One end has a 1" wide spring clip with a maximum grip of 1-1/8" dia.
- Other end has a 2" wide x 7/8" height sign holder that can display material from .008" to .020" thick
- Plastic material
- Packaged 25 per bag

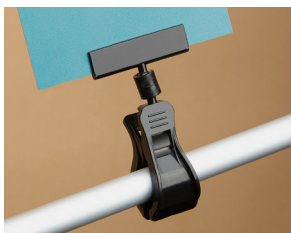
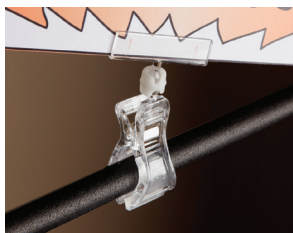

ITEM #	OVERALL LENGTH	COLOR
150304	4"	Clear
150304B	4"	Black

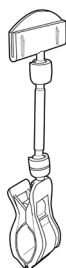

Heavy Duty Clip-On Extended Knuckle Sign Holder

Large heavy duty spring clip base is lined with anti-slip coating and securely attaches to thicker fixtures. Extended length sign holder top is great for holding medium to small size signs. Our durable pivoting swivel system allows for the display of signs and promotions at unique angles.

- 2" long center extender joining two clips via swivel knuckles
- One end has a 1" wide spring clip with a maximum grip of 1-1/8" dia.
- Other end has a 2" wide x 7/8" height sign holder that can display material from .008" to .020" thick
- Plastic material
- Packaged 25 per bag



ITEM #	OVERALL LENGTH	COLOR
150305	6"	Clear
150305B	6"	Black

Double Clip-On Knuckle Sign Holder

Two crystal clear spring clips that can be positioned vertically, horizontally or any direction in between. Securely attach either end to wires, fixtures, displays, signs or promotions. Our durable pivoting swivel system allows for unique angles in any retail environment.

- Two identical clips joined by a white swivel knuckle
- Both clips are 3/4" wide with a maximum grip of 3/8" dia.
- Clear plastic material
- Packaged 50 per bag

ITEM #	OVERALL LENGTH
150300	3-1/2"



Double Clip-On Curly Wire

Attach two signs or use one spring clip as a base. Color coated wire can be spiral wound or wrapped around almost anything. Our durable pivoting swivel system allows for unique angles for displaying signs and promotions. Designed for any retail environment from grocery to apparel.

- .125" diameter white PVC coated bendable center wire joining two identical clips via white swivel knuckles
- Both spring clips are 3/4" wide and can fit signs or fixtures up to 5/16" thick
- Clips are clear plastic material
- Also available with black PVC coating
- Packaged 25 per bag

ITEM #	OVERALL LENGTH
150309	12"

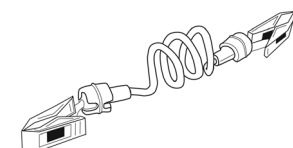

Magnetic Clip-On Curly Wire

Use the spring clip end to attach a sign for eye-catching attention. Strong, versatile magnetic base attaches to metal surfaces such as shelving. Our durable pivoting swivel system allows for unique angles for displaying signs and promotions in any retail environment.

- .125" dia. white PVC coated bendable center wire joining two ends via white swivel knuckles
- One end has a round 3/4" diameter magnetic base
- Other end has a clear 3/4" wide spring clip that fits signs & promotions up to 5/16" thick
- Clips are clear plastic material
- Packaged 25 per bag

ITEM #	OVERALL LENGTH
150310	12"





Magnetic Clip-On Knuckle Wire Sign Holder

Use the spring clip end to attach a sign for eye-catching attention. Strong, versatile magnetic base attaches to metal surfaces such as shelving. Our durable pivoting system allows for unique angles for displaying signs and promotions in any retail environment.

- Thin, nickel plated spring steel center wire joining two ends via white swivel knuckles
- One end has a round 3/4" diameter magnetic base
- Other end has a clear 3/4" wide spring clip that fits signs or promotions up to 3/8" thick
- Clear plastic material
- Packaged 25 per bag



ITEM #	OVERALL LENGTH
150307	7"

Clip-On Knuckle Wire Sign Holder

Spring clip base securely attaches to fixtures or other signs. Mini sign holder top is great for holding small signs. Our durable pivoting system allows for unique angles for displaying signs and promotions in any retail environment.

- Thin, nickel plated spring steel center wire joining two ends via white swivel knuckles
- One end has a 3/4" wide spring clip with a maximum grip of 3/8" diameter
- Other end has a 1" wide x 5/8" height mini sign holder that can display material from .008" to .020" thick
- Clear plastic material
- Packaged 25 per bag



ITEM #	OVERALL LENGTH
150313	7-1/2"

Adhesive Clip-On Knuckle Sign Holder

Round adhesive backed base sticks to displays, fixtures or other signs. Spring clip top is great for holding signs or promotions. Our durable pivoting swivel system allows for the display of advertisements at unique angles in any retail environment.

- Two ends joined by a white swivel knuckle
- One end has a 3/4" wide spring clip with a maximum grip of 3/8" dia.
- Other end has a 1-1/8" dia. round adhesive backed white base
- Clear plastic material
- Packaged 50 per bag



ITEM #	OVERALL LENGTH
150308	2-1/4"

Suction Cup Clip-On Knuckle Wire Sign Holder

Use the spring clip end to attach a sign for eye-catching attention. Suction cup base is great for hot or cold extremes and can be applied to any clean, non-porous surface. Our durable pivoting system allows for unique angles for displaying signs and promotions in any retail environment.

- Thin, nickel plated spring steel center wire joining two ends via white swivel knuckles
- One end has a clear 3/4" wide spring clip that fits signs or promotions up to 5/16" thick
- Other end has a 1-3/4" O.D. clear PVC suction cup base
- Clip is made of clear plastic material
- Packaged 25 per bag

ITEM #	OVERALL LENGTH
150306	6-1/2"

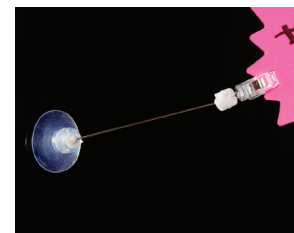
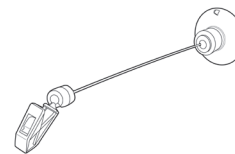

Clever Clip Suction Cup

Perfect for windows and cooler doors. Strong spring clip holds just about anything and swivels/rotates in opposite directions. High-quality cup with unique reinforced rings for added strength and long-term holding power. Apply to clean, non-porous surface for best results.

- For use in hot or cold extremes
- 5/16" wide spring clip joined to a split ring top
- Spring clip has a strong maximum grip capacity of 3/16"
- Cup and swivel come pre-assembled
- Clip is white polypropylene material
- Suction cup is clear UV resistant PVC material – won't yellow or become brittle
- Also available with a black clever clip

ITEM #	CUP DIAMETER	INCLUDES
130623	1-3/4"	Suction Cup & Swivel Clip

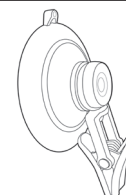

Kinter's in-house featured services include injection molding & custom extrusion, design and 3D printing, and fulfillment.

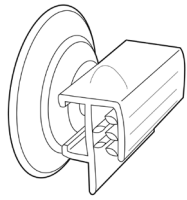

Suction Cup With Flush Gripper

High-quality cup with unique reinforcing rings for added strength and long-term holding power. Gripper fins hold sign securely in flush position. Ideal for window mounted signs. Apply to clean, non-porous surface for best results.

- For use in hot or cold extremes
- Cup comes assembled with 5/8" height "J" style gripper
- Gripper holds signs up to .080" thick
- Suction cup is clear UV resistant PVC material – won't yellow or become brittle



ITEM #	CUP DIAMETER	GRIPPER LENGTH	SIGN POSITION
130616	1-1/8"	1"	Flush

Sign & Literature Holders

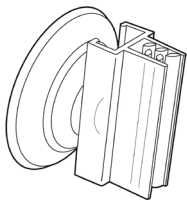

Suction Cup With Flag Gripper

High-quality cup with unique reinforcing rings for added strength and long-term holding power. Gripper fins hold sign securely in flag position. Ideal for window mounted signs. Apply to clean, non-porous surface for best results.

- For use in hot or cold extremes
- Cup comes assembled with 5/8" height gripper
- Gripper holds signs up to .080" thick
- Suction cup is clear UV resistant PVC material – won't yellow or become brittle



ITEM #	CUP DIAMETER	GRIPPER LENGTH	SIGN POSITION
130613	1-1/8"	1"	Flag
130614	1-3/4"	1-3/4"	Flag

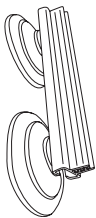

Double Suction Cup With Flag Gripper

High quality cups with unique reinforcing rings for added strength and long-term holding power. Gripper fins hold signs securely in flag position. Longer gripper length is ideal for larger window or cooler door mounted signs. Apply to clean, non-porous surfaces for best results. Removable and reusable.

- For use in hot or cold extremes
- Two cups that come assembled with 5/8" height x 3-1/2" long gripper
- Gripper holds signs up to .080" thick and is made of clear PVC material
- Suction cups are UV resistant PVC material – won't yellow or become brittle

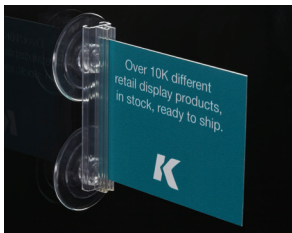

ITEM #	DIAMETER OF CUPS	GRIPPER LENGTH	SIGN POSITION
130621	1-3/4"	3-1/2"	Flag

Economy Suction Cup With Flush Gripper

Our least expensive cup, while not sacrificing quality. Long term holding power in both hot or cold temperature ranges. Gripper fins hold sign securely in flush position. Ideal for window mounted signs. Apply to clean, non-porous surface for best results.

- Cup comes assembled with 5/8" height "J" style gripper
- Gripper holds signs up to .080" thick
- Suction cup is clear vinyl material
- Gripper is clear PVC material
- Packaged 100 pieces per bag

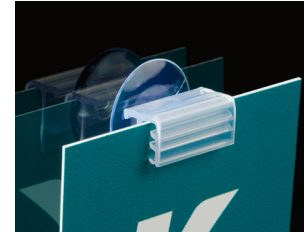
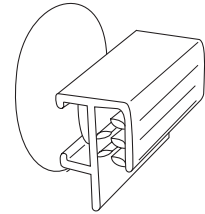

ITEM #	CUP DIAMETER	GRIPPER LENGTH	SIGN POSITION
130632	1"	1"	Flush

Economy Suction Cup With Flag Gripper

Our least expensive cup, while not sacrificing quality. Long term holding power in both hot or cold temperature ranges. Gripper fins hold sign securely in flag position. Ideal for window mounted signs. Apply to clean, non-porous surface for best results.

- Cup comes assembled with 5/8" height gripper
- Gripper holds signs up to .080" thick
- Suction cup is clear vinyl material
- Gripper is clear PVC material
- Packaged 100 pieces per bag

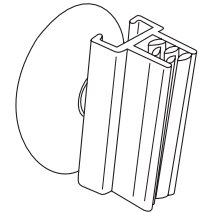

ITEM #	CUP DIAMETER	GRIPPER LENGTH	SIGN POSITION
130630	1"	1"	Flag
130631	1-3/4"	1-3/4"	Flag

Self-Piercing Suction Cup Flag Sign Holder

Very popular, reusable suction cup clip featuring a piercing male pin that easily folds and punctures paper signs for a secure hold. Holds paper signs in flag position. Great for ever-changing sale signs on cooler doors. Apply to clean, non-porous surface for best results.

- 3/4" wide x 1-1/4" height
- 7/8" fold section on clip
- 1" diameter mushroom head suction cup
- Clip & suction cup come assembled
- Holds paper signs up to .012" thick
- Clip is natural polypropylene material
- Suction cup is clear PVC material
- Packaged 100 per bag

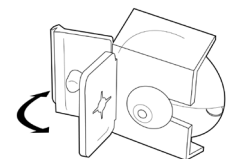

ITEM #	SIGN POSITION
130617	Flag

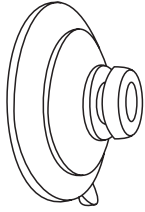

Premium Suction Cup – Mushroom Head

High-quality cup with unique reinforcing rings for added strength and long-term holding power. Ideal for keyhole openings, holes or grommets. Simplified design accommodates a wide range of signs, posters or self hanging products. Apply to clean, non-porous surface for best results.

- For use in hot or cold extremes
- Additional sizes available
- Clear UV resistant PVC material – won't yellow or become brittle

ITEM #	SIZE	CUP DIAMETER	HEAD O.D.	NECK O.D.	NECK LENGTH
130601	Mini	3/4"	.275"	.150"	.080"
130602	Small	1-1/8"	.395"	.254"	.068"
130603	Medium	1-3/4"	.595"	.346"	.100"
130604	Large	2-1/2"	.584"	.332"	.078"

Sign & Literature Holders

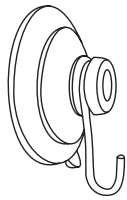

Premium Suction Cup – Metal Hook

Strong, corrosion resistant plated steel hook is ideal for window mounted signs or self-hanging products. Easy one step hanging. High-quality cup with unique reinforcing rings for added strength and long-term holding power. Apply to clean, non-porous surface for best results.

- For use in hot or cold extremes
- Additional sizes available
- Clear UV resistant PVC material – won't yellow or become brittle

ITEM #	SIZE	CUP DIAMETER
130609	Mini	3/4"
130610	Small	1-1/8"
130611	Medium	1-3/4"
130612	Large	2-1/2"

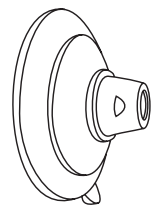

Premium Suction Cup – Pilot Hole

Top pilot hole can be screwed into with common type "B" steel tapping screw (sold separately) for permanent mount. Also accepts press-in male thumbtack (sold separately) for holding signs firm. Designed to hang a variety of products. High-quality cup with unique reinforcing rings for added strength and long-term holding power. Apply to clean, non-porous surface for best results.

- 3/32" diameter top pilot hole size
- For use in hot or cold extremes
- Additional sizes available
- Clear UV resistant PVC material – won't yellow or become brittle

ITEM #	SIZE	CUP DIAMETER
130605	Mini	3/4"
130606	Small	1-1/8"
130607	Medium	1-3/4"
130608	Large	2-1/2"

Suction Cup With Thumbtack

Perfect for windows or cooler doors. Tack holds signs firmly in place. High-quality cup with unique reinforcing rings for added strength and long-term holding power. Apply to clean, non-porous surface for best results.

- For use in hot or cold extremes
- Suction cup is our #130607 1-3/4" O.D. Premium Suction Cup
- Thumbtack is our #120327C 5/8" O.D. round head male Snap Rivet
- Thumbtack has barbed tip for tamper resistant, heavy duty holding power
- Suction cup & thumbtack come unassembled
- Additional tack lengths available
- Suction cup is made of clear UV resistant PVC material – won't yellow or become brittle
- Thumbtack is made of clear polycarbonate material
- Packaged 100 cups and 100 thumbtacks per bag

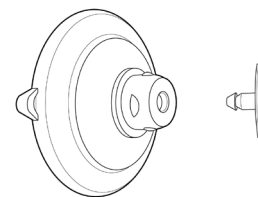

ITEM #	CUP DIAMETER	INCLUDES
130618	1-3/4"	Suction Cup & Clear Thumbtack

Suction Cup With Thumb Screw

High-quality cup with unique reinforcing rings for added strength and long-term holding power. Ideal for window mounted signs, merchandising strips or self-hanging products. Can be removed and reused. Apply to clean, non-porous surface for best results.

- For use in hot or cold extremes
- Cup comes assembled with an 8-32 x 1/2" (approx.) long stud made of zinc plated steel material
- Recommended hole size is 3/16"
- Mating thumb nut is .415" O.D. x .320" overall height and made of natural nylon material
- Thumb nut comes unassembled from stud
- Suction cup is clear UV resistant PVC material – won't yellow or become brittle
- Packaged 100 cups and 100 nuts per bag

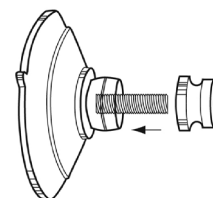

ITEM #	CUP DIAMETER	INCLUDES
130615	1-3/4"	Suction Cup, Thumb Screw & Nut

Suction Cup With Metal Screw

Perfect for windows or cooler doors. Metal screw securely holds signs. Screw has blunt tip so it will not pierce the cup. High-quality cup with unique reinforcing rings for added strength and long-term holding power. Apply to clean, non-porous surface for best results.

- For use in hot or cold extremes
- Suction cup is our #130607 1-3/4" O.D. Premium Suction Cup
- Metal screw is a #8 x 3/8" long Phillips pan head type "B" sheet metal screw
- Suction cup & metal screw come unassembled
- Longer length screws also available
- Suction cup is made of clear UV resistant PVC material – won't yellow or become brittle
- Screw is zinc plated steel
- Packaged 100 cups and 100 screws per bag

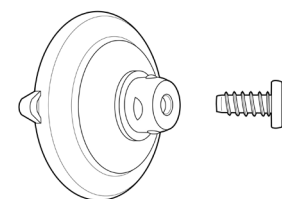

ITEM #	CUP DIAMETER	INCLUDES
130619	1-3/4"	Suction Cup & Metal Screw

NEW

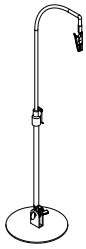

Goose Neck Telescopic Sign Holder With Spring Clip

Versatile “goose neck” securely hangs small signs, tags or promotions. Neck pivots using a built-in thumb screw, rotates 360 degrees, and can be raised or lowered. Round base slips under boxes or product, or sits as a standalone. Metal clip has small teeth powered by a metal spring.

- Accepts sign materials up to 0.150" thick
- Clip is zinc plated steel
- Stem and base are black powder coated steel
- Additional finishes or sizes available - please inquire

ITEM #	OVERALL HEIGHT	BASE O.D.	COLOR
150703B	13-1/2" to 20"	4"	Black



Spiral Base Card Holder

Versatile Split ring top holds signs, tags and promotions securely. Stable coiled style base can be used on flat surfaces or beneath product. Perfect for attractively displaying signs on counters, tables or shelves. Also known as Swirl Card Holders.

- Accepts sign materials up to .025" thick
- Split ring top is 17/32" I.D. x 25/32" O.D.
- 1/8" wire diameter
- Black powder coated steel
- Also available with chrome finish
- Additional finishes, colors or heights available – please inquire

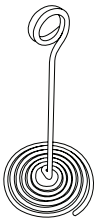

ITEM #	OVERALL HEIGHT	BASE O.D.	COLOR
150209B	1-3/4"	2-1/2"	Black
150408B	3-1/2"	2-1/2"	Black
150210B	5"	2-1/2"	Black
150211B	7"	2-1/2"	Black

Harp Clip Sign Holder

Elegantly display small signs or cards in hot or cold environments, as well as counters or tabletops. Heavy weighted base is stable. Adds a classy touch to any display.

- Accepts sign materials up to .025" thick
- 6" and 8" styles have 3/16" diameter stem; 1-1/2" style has a wider stem
- Additional heights available - please inquire

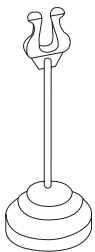

#150424 and #150428 (sold separately)

ITEM #	OVERALL HEIGHT	BASE O.D.	FINISH
150428	1-1/2"	1-1/16"	Stainless Steel
150424	6"	2-3/8"	Stainless Steel
150423	8"	2-3/8"	Stainless Steel

Sign & Literature Holders

Freestanding Sign Holder With Spring Clip

Simple freestanding clip securely holds small signs, tags or promotions. Round shovel base easily slips under boxes or product, or sits as a standalone on counters, tables or shelves. Metal clip has small teeth powered by a metal spring.

- Accepts sign materials up to .150" thick
- 5/32" stem diameter
- Clip is zinc plated steel
- Stem and base are black powder coated steel
- Additional finishes, colors or heights available – please inquire
- Packaged 10 per bag

ITEM #	OVERALL HEIGHT	BASE O.D.	COLOR
150263B	3"	4"	Black
150266B	6"	4"	Black
NEW 150706B	3"	2"	Black



Weighted Base Sign Holder With Gripper

Thick, weighted base keeps signs upright and adds a classy touch, suitable for any display. Sometimes called a "European style" or "contour" base. Attached gripper (included) holds signs firmly.

- 1-1/2" long gripper accepts sign materials up to .025" thick
- 5/32" stem diameter
- Also available with metal clip (Gator clip) - please inquire
- Additional heights available - please inquire
- Black coated steel

ITEM #	OVERALL HEIGHT	BASE O.D.	COLOR
150431B	3"	2-1/4"	Black
150430B	6"	2-1/4"	Black

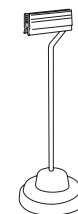

Spiral Cone Card Holder

Versatile split ring top holds signs, cards and promotions. Stable cone-coil base attractively displays signs on any flat surface. Also known as Menu Card Holders or Number Stands.

- Accepts sign materials up to .025" thick
- 1/8" wire diameter
- Black powder coated steel
- Also available with chrome finish
- Additional heights available - please inquire

ITEM #	OVERALL HEIGHT	BASE O.D.	COLOR
150426B	6"	3"	Black

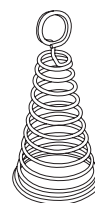

Weighted Base Flat Sign Holder

Compact base with adjustable arm securely holds small signs, tags or promotions. Nicely weighted to keep signs upright. Flexible arm allows metal clip to bend upward to desired angle. Clip has small teeth powered by a metal spring.

- Accepts sign materials up to 0.150" thick
- Clip is zinc plated steel
- Triangular steel base is 1-3/4" wide, vinyl coated
- Features rounded corners for safety

ITEM #	OVERALL LENGTH	COLOR
150707B	3-3/4"	Black

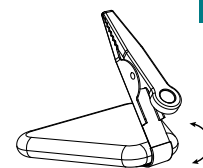

NEW



Sign & Literature Holders

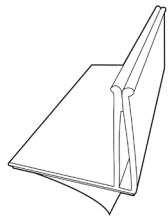

“L” Style Sign Holder With Adhesive

Inexpensive card holder that is great for countertops. Extra wide base offers superior stability. Signs slide easily and securely into friction fit top holder in vertical (flag) or horizontal position. Adhesive bottom adheres to clean, flat surfaces.

- “L” shaped base with adhesive
- Available in custom lengths, without adhesive or with a magnet
- Clear PVC material



ITEM #	LENGTH	BASE WIDTH	HEIGHT	GRIP CAPACITY
108633	3-1/2"	2"	1-1/2"	up to .125"
108634	6"	2"	1-1/2"	up to .125"

Gripper L-Style Table Top Sign Holder

Gripper fins coupled with an extra wide base that is designed for holding freestanding advertisements or cards on the top of tables or counters. Can also be used in conjunction with our line of Diamond Hole Shelf Dart or Push-In Clips (see page 211) for attachment directly to common diamond or square perforated shelf holes. Use two or more holders for larger signs or category headers.

- “L” shaped base with two .200" slotted holes
- Custom lengths available
- Also available with adhesive or magnets – please inquire
- Clear PVC material

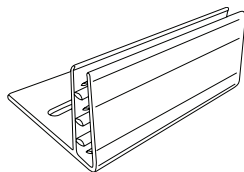

ITEM #	LENGTH	BASE WIDTH	HEIGHT	GRIP CAPACITY
108755	3"	2-1/4"	1-1/4"	.187" to .250"

Economy Card Holder

Our most economical adhesive backed card holder. Great for countertops. Signs slide easily and securely into friction fit top holder in either vertical (flag) or horizontal position. Adhesive bottom adheres to any clean, flat surface.

- Also available without adhesive or with a magnet
- Custom lengths available
- Clear PVC material

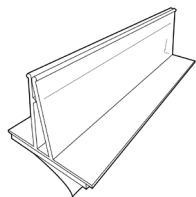

ITEM #	LENGTH	BASE WIDTH	HEIGHT	GRIP CAPACITY
108587	3"	1-1/8"	7/8"	up to .125"
108586	6"	1-1/8"	7/8"	up to .125"

Table Top Card Holder

An easy, inexpensive way to make small paper signs or cards stand up and get noticed. Signs slide easily and securely into friction fit top holder. Recommended for counter or desk tops. Large base offers great stability.

- 7/16" height
- Ribbed design holds material up to .036" thick
- Not recommended for plastic signs
- Clear styrene material
- Packaged 100 per bag

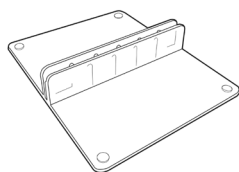

ITEM #	BASE WIDTH	BASE LENGTH	GRIP CAPACITY
107136	2"	1-3/4"	up to .036"

Sign & Literature Holders

Easel Card Holder – Angled

An easy, inexpensive way to make small paper signs or cards stand up and get noticed. Secure, angled design for better viewing. Recommended for counter/desk tops or display cases. Large base offers great stability.

- 1/2" height
- Ribbed design holds material up to .036" thick
- Not recommended for plastic signs
- Clear styrene material
- Packaged 100 per bag

ITEM #	BASE WIDTH	BASE DEPTH	GRIP CAPACITY
107135	1-9/16"	2-3/8"	up to .036"

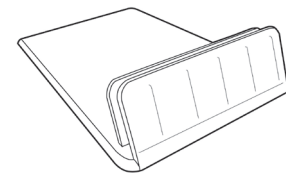

Crystal Easel Ticket Holder

Attractive card holder with glass-like appearance that is great for counter tops and display cases. Easel-back angled design for better viewing and stability.

- 1-1/4" wide x 1" deep with 5/8" front lip height
- Holds signs and cards up to .080" thick
- Clear PVC material

ITEM #	WIDTH	COLOR
108691	1-1/4"	Clear

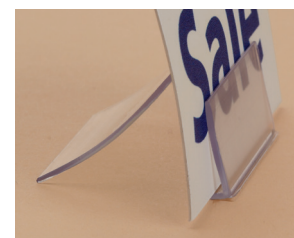
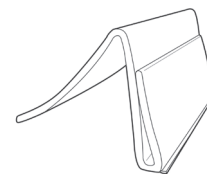

Kinter delivers the highest-quality and most diverse selection of products, even if that means creating a new custom solution to meet your exact specifications.

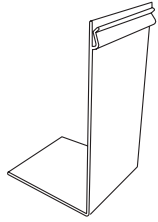

Easel Card Holder

An easy, inexpensive way to make small signs or cards stand up and get noticed. Shovel base slides under bowls, trays, pans or fixtures. Display pricing or promotional messages in the deli, bakery, seafood or other departments. Can stand alone if used with a lightweight sign.

- Accepts rigid graphics up to .022" thick
- Other lengths or heights available - please inquire
- Clear butyrate material

ITEM #	HEIGHT	WIDTH	BASE DEPTH
108893	4"	2"	2-1/2"

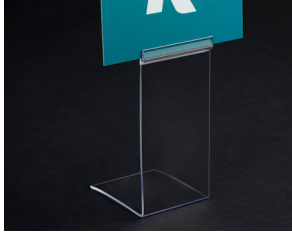

Sign & Literature Holders

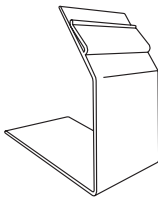

Easel Card Holder – Elevated Angled

An easy, inexpensive way to make small signs or cards stand up and get noticed. Bottom of sign is lifted approximately 1-7/8" off the ground, with an angled design for ideal viewing. Unit easily stands on its own, or can also slip under products using the extra-long shovel base. Recommended for counters, desks and display cases.

- Recommended sign thickness is .013" to .070"
- .060" thick material
- Clear PVC

ITEM #	HEIGHT	WIDTH	BASE DEPTH
140630	1-7/8"	1-5/8"	2-1/2"

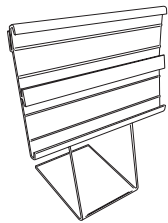
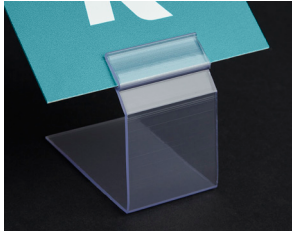

Easel Track Sign Holder

Clear, freestanding easel supports a two-track sign holder - ideal for deli cases or countertops. Channel tracks display 1-1/4" height signs, or 2-1/2" height signs when spread across both tracks. Includes a friction-fit slot that runs along the top edge for additional signage to rise above.

- Combine promotional and pricing information
- #140674B sits flush to the surface; #140765B rises 2" above
- Each track accepts 1-1/4" height signs; 2-1/2" height signs when spread over both tracks
- Custom styles and colors available
- Base is clear PVC; track is black PVC

ITEM #	STYLE	BASE HEIGHT	BASE DEPTH	BASE COLOR	TRACK LENGTH	TRACK COLOR	OVERALL HEIGHT
140674B	2-Track	0"	2-1/4"	Clear	4"	Black	2-1/2"
140765B	2-Track	2"	2-1/4"	Clear	4"	Black	4-1/2"



Print Protectors

Display and protect promotions or critical information on counters, walls, displays or other flat surfaces while preventing curled graphic corners. Provides quick-change, long lasting performance. Signs are framed on three sides by a thin, clear rigid sleeve-like border for an attractive presentation. Can be mounted with hook and loop fasteners, flexible magnets or various other adhesive products (all sold separately).

- Sleeve opens on short side of protector
- Works in either portrait or landscape position
- Other sizes available – please inquire
- Clear 15 mil PVC material
- Packaged 5 per bag

ITEM #	SIGN SIZE	STYLE
107408	4" x 6"	Portrait or Landscape
107409	8-1/2" x 11"	Portrait or Landscape

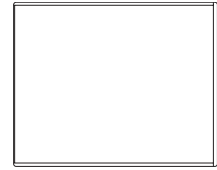

Static Cling Print Protector

Create your own static cling message with this inexpensive clear overlay. Display and protect graphics, messages or critical information on glass without the need for messy tape or adhesive. Can be positioned either horizontal or vertical and can be used over and over again. Perfect for windows or cooler doors.

- Indoor working temperature range is 32 to 82 degrees Fahrenheit
- Flexible static cling sheet size is 4-1/2" x 6"
- .006" static cling material thickness with factory peel-away liner
- Other sizes available – please inquire
- Clear thin static cling PVC material
- Packaged 50 per bag
- Sold in full bags only

ITEM #	MAXIMUM SIGN SIZE	STYLE
107407	3-1/2" x 5"	Portrait or Landscape

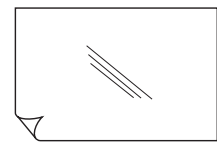

Economy Squeegee Applicator

Our most economical squeegee applicator tool. Extremely popular, high-quality product that is ideal for light to medium weight graphic film, vinyl, tape, silk screen and pressure-sensitive applications. Soft, comfortable feel in hand with no sharp edges. Commonly used for applying vinyl graphics, signs or advertisements to windows, walls, vehicles and more. Featuring mid-level memory, high flexibility and high glide. Durable and reusable.

- Flat edge surface with radial corners
- Low profile "indent" style applicator
- 5/32" thick
- Poly blend material
- Other colors and materials available – please inquire

ITEM #	WIDTH	HEIGHT	COLOR
109512W	4"	2-3/4"	White

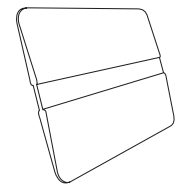

Vinyl Pouch With Hanging Hole

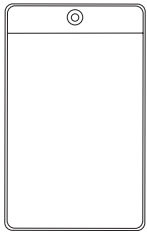

Inexpensive, heat sealed clear vinyl pouch with reinforced center hanging hole on top that assures sign protection. Easily mount to wire baskets, shelves or pallet uprights with a wide variety of hanging options such as Cable Ties (Locking Straps), Rings or Beaded Chain (all sold separately). Signs slide in easily through top pouch opening.

- Sealed on three sides with opening on top side
- Approximate 3/4" height header area
- .250" diameter heat-welded style single grommet hole
- Width and height sizes are based on intended sign insert size
- All pouches are slightly larger than the listed width and height for ease of use
- Custom sizes available – please inquire
- Clear vinyl material with UV inhibitors to prevent discoloration
- Packaged 25 per bag
- Sold In full bags only



ITEM #	WIDTH	HEIGHT
150062	3"	5"
150061	4"	6"

Vinyl Pouch With Two Mounting Holes



Heat sealed clear vinyl pouch that is specifically designed to hold common 1-1/4" height by 5" wide, non-adhesive backed price tags. Protective pocket that opens from the short side and allows tag inserts to slide in or out easily with the aid of an integrated back-side lip. Great for hanging from wire shelves, fixtures or baskets via multiple hanging options such as Plastic Overlap Rings, Spiral Rings or Cable Ties (all sold separately).

- Sealed on three sides with opening on short side
- Two 3/16" diameter thru-punched style holes
- Width and height sizes are based on intended sign insert size
- Actual overall size is slightly larger than the listed width and height for ease of use
- Custom sizes available – please inquire
- Clear vinyl material with UV inhibitors to prevent discoloration



ITEM #	WIDTH	HEIGHT
150051	5"	1-1/4"

Several hanging options available (sold separately)



Plastic Snap Rings (page 233)



Plastic Spiral Rings (page 233)



Plastic Overlap Rings (page 233)

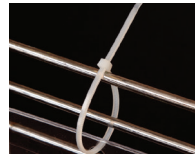

Cable Ties (page 202)



Loop Style Locking Strap (page 203)



Beaded Chain (page 273)

Vinyl Pouch With Side Opening

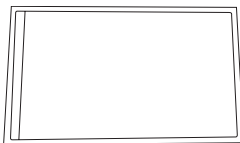

Heat sealed clear vinyl pouch that is designed to hold common sign and tag sizes on flat surfaces. Protective pocket that opens from the short side and allows signs to slide in or out easily with the aid of an integrated back-side lip. Great for always changing messages. Hang with Hook & Loop Fasteners or Flexible Magnets (sold separately).

- Sealed on three sides with opening on short side
- Width and height sizes are based on intended sign insert size
- Actual overall size is slightly larger than the listed width and height for ease of use
- Custom sizes or parts produced with magnetic backing also available – please inquire
- Clear vinyl material with UV inhibitors to prevent discoloration



ITEM #	WIDTH	HEIGHT
150052	5-1/2"	3-1/2"

Vinyl Pouch With Adhesive

Heat sealed clear vinyl pouch that is designed to hold common sign sizes on clean, flat surfaces. Protective pocket that allows signs to slide in or out easily with the aid of an integrated back-side lip. Great for always changing messages. Full adhesive backing is perfect for shelving fronts or pallet rack cross members.

- Sealed on three sides with opening on side shown below
- Width and height sizes are based on intended sign insert size
- Actual overall size is slightly larger than the listed width and height for ease of use
- Custom sizes or parts produced with magnetic backing also available – please inquire
- Clear vinyl material with UV inhibitors to prevent discoloration
- Sold in full bags only

ITEM #	WIDTH	HEIGHT	POUCH OPENING	PACKAGED
150057	4"	3"	on 4" Side	10 per sheet/100 per bag
150055	5-1/2"	3-1/2"	on 3-1/2" Side	10 per sheet/100 per bag
150058	6"	4"	on 4" Side	6 per sheet/102 per bag
150056	11"	8-1/2"	on 8-1/2" Side	2 per sheet/100 per bag

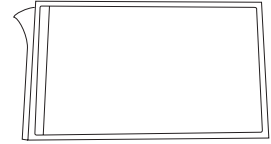

Vinyl Pouch Tag Pocket With Adhesive

Heat sealed clear vinyl pouch that is specifically designed to hold common 1-1/4" height, non-adhesive backed price tags. Protective pocket that opens from the short side and allows tag inserts to slide in or out easily with the aid of an integrated thumb notch. Full adhesive backing sticks to any clean, flat surface such as shelving fronts.

- Sealed on three sides with opening on short side
- Front only .500" wide centered thumb notch on open side
- Width and height sizes are based on intended price tag insert size
- Actual overall size is slightly larger than the listed width and height for ease of use
- Custom sizes available – please inquire
- Clear vinyl material with UV inhibitors to prevent discoloration
- Packaged 48 pockets per sheet, 240 pockets per bag
- Sold in full bags only

ITEM #	WIDTH	HEIGHT
150050	2"	1-1/4"

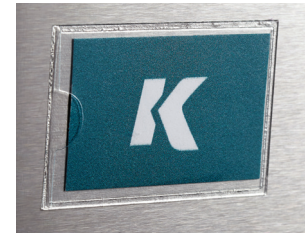
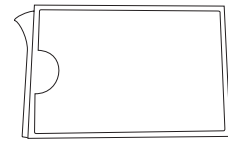

Vinyl Pouch With Magnetic Strips

A simple way to display signs or pricing information on a magnetic surface. Inexpensive, heat sealed clear vinyl pouch with two flexible magnetic strips attached to the back. Great for ever-changing messages.

- Sealed on three sides with opening on short side
- Width and height sizes are based on intended sign insert size
- Actual overall size is slightly larger than the listed width and height for ease of use
- Custom sizes available – please inquire
- Magnetic strips are 5-3/4" long x 1/2" wide x .060" thick
- Clear vinyl material

ITEM #	WIDTH	HEIGHT
150054	5-1/2"	3-1/2"

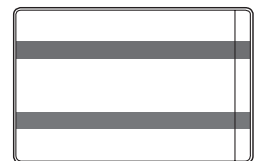

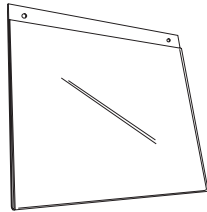

Rigid Covered Sign Holder With Holes

A borderless frame that provides quick side or top change and long lasting performance. Designed for use with our Extra Height Adjustable Pallet Sign Holder #150214B (sold separately) as a free swinging promotional literature holder. Simply insert your custom printed sign into the protective clear cover and hang from the pre-welded hooks. Also can be used to display messages from walls or other flat surfaces or for windows when combined with our Suction Cup With Metal Hook (see page 162).

- Deluxe .070" - .080" thick virgin acrylic
- Side or top load signs quickly and easily
- Back panel has two 3/8" diameter pre-drilled holes at 9" on center
- Custom imprinting and other sizes available – please inquire
- Crystal clear acrylic material



ITEM #	SIGN SIZE	HOLE SPACING	STYLE
107414	11" Width x 8-1/2" Height	9" on center	Landscape

Sign & Literature Holders

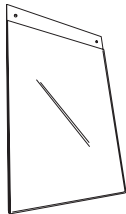

Acrylic Wall-Mount Sign Holder

Attractively showcase and protect graphics and promotional literature from walls, displays or other flat surfaces while preventing curled graphic corners. A borderless frame that provides quick side or top change, and long lasting performance. Can be mounted with screws using the integrated top holes or attached with Hook & Loop Fasteners or various other adhesive products. Also great for windows when combined with our Suction Cup With Metal Screw (see page 163).

- Deluxe .070" - .080" thick virgin acrylic
- Side or top load signs quickly and easily
- Back panel has two 3/16" diameter pre-drilled holes
- Mounting hardware not included
- Custom imprinting and other sizes available – please inquire
- Crystal clear acrylic material



ITEM #	SIGN SIZE	HOLE SPACING	STYLE
107410	11" Width x 8-1/2" Height	8-5/16"	Landscape
107411	8-1/2" Width x 11" Height	5-13/16"	Portrait

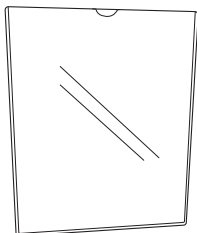

Wall-Mount Sign Holder

Showcase and protect graphics and promotional literature on walls, displays or other flat surfaces while preventing curled corners. Crystal clear, borderless frame allows quick sign change and long-lasting performance. Can be featured in portrait or landscape orientation.

- Insert signs into short side of holder
- Features a thumb notch for easy removal
- #150364 comes with two magnetic strips applied, for easy attachment to most metal surfaces
- #150349 comes with peel-and-stick hook & loop (mated), for easy attachment to smooth, dry surfaces
- Clear polystyrene



ITEM #	SIGN SIZE	STYLE	TYPE OF BACKING
150351	8-1/2" x 11"	Portrait or Landscape	Plain
150364	8-1/2" x 11"	Portrait or Landscape	Magnetic
150349	8-1/2" x 11"	Portrait or Landscape	Hook & Loop



Business Card Holder

Offer standard-sized business cards on desks, tables or counters. Adds a professional appearance to any setting. Winged-back, single-pocket design ensures that cards remain upright.

- Holds business cards or small literature up to 3-5/8" wide
- Displays up to 50 business cards
- Extended back keeps cards propped up
- Deluxe .080" thick plastic
- Crystal clear styrene

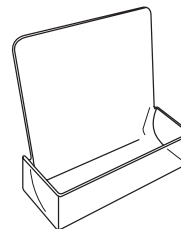

ITEM #	WIDTH	BACK HEIGHT	DEPTH
150136	4"	3-1/2"	1"

Rigid Wall Mount Coupon Holder

Attractively showcase coupons, recipes or product information from flat surfaces such as walls, windows or display boards. Can be mounted with our premium mushroom head suction cups (sold separately – see page 162) or common #6 diameter screws (also sold separately – please inquire). Sits perfectly as a freestanding holder on countertops as well.

- Deluxe .080" - .090" thick styrene
- Designed for common 6" wide coupons
- Frontside is notched and a bit shorter than backside for improved visibility
- Two backside keyholes at 3-1/2" on center accept either our small, medium or large mushroom head suction cups
- Two additional backside round holes are 5/32" diameter and 1-1/8" on center
- Can also be mounted with double-sided tape or cable ties (sold separately)
- Crystal clear styrene material

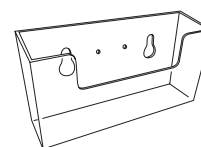

ITEM #	WIDTH	BACK HEIGHT	DEPTH
150811	6-1/4"	3-1/4"	1-1/4"

Business Card Holder For Pegboard/Slatwall

NEW

Offer business cards or other small objects on common pegboard or slatwall. Handy thumb notch makes "take one" easy. Adds a professional appearance to displays.

- Displays business cards or small objects up to 3-1/2" wide
- Holds up to 50 business cards
- Deluxe .065" thick plastic
- Crystal clear styrene

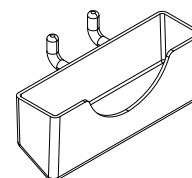

ITEM #	WIDTH	HEIGHT	DEPTH
150417	3-3/4"	1-1/2"	1"

Sign & Literature Holders

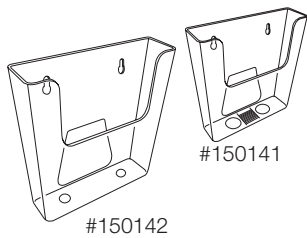

Rigid Wall Mount Literature Holder

Attractively hang and showcase literature against a wall or other fixtures via fasteners (sold separately) or mount to glass with suction cups (sold separately) using the built-in holes. Not intended as a freestanding pocket.

- #150141 holds literature up to 5-7/8" wide, with bottom ridges to keep literature from sliding
- #150142 holds literature up to 8-1/2" wide, with a smooth bottom
- Frontside is notched for improved visibility
- Deluxe .065" - .085" thick plastic
- Crystal clear styrene

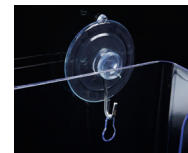

Suction cups sold separately (see pages 162 & 163)



ITEM #	WIDTH	HEIGHT	DEPTH	BOTTOM
150141	6-1/4"	6-1/2"	1-1/2"	Ridges
150142	9"	9-1/2"	2"	Smooth

Sign & Literature Holders

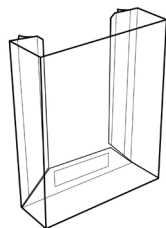

Literature Pockets

Inexpensively create a lightweight literature pocket on any clean, flat surface. Pre-applied adhesive strips hold securely to display boards, panels and easels. Provided flat and folds up to accept literature, or for an added cost also available in convenient pre-formed shape.

- 1-1/4" depth
- With three adhesive backed, miter cut panels
- 15 mil thick, clear rigid PVC material



ITEM #	ASSEMBLED WIDTH	ASSEMBLED HEIGHT	PACKAGED
150105	4"	5"	Flat
150108	4"	5"	Pre-Formed
150106	6-1/8"	5"	Flat
150109	6-1/8"	5"	Pre-Formed
150107	8-1/2"	7"	Flat
150110	8-1/2"	7"	Pre-Formed

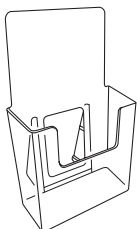

Rigid Freestanding Literature Holder

Attractively showcase tri-fold literature, pamphlets or brochures. Sits perfectly stable as a freestanding holder on tops of tables, shelves, desks or counters. Slant back, single-pocket design ensures that literature remains upright.

- Holds literature up to 4" wide
- Double backside wing design for increased stability
- Base measures 3-1/4" deep
- Deluxe .070" - .080" thick styrene
- Frontside is notched for improved visibility
- Crystal clear styrene material



ITEM #	WIDTH	BACK HEIGHT	DEPTH
150826	4-5/16"	7"	1-5/16"

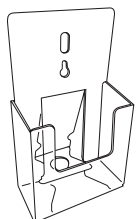

Fold-Up Rigid Literature Holder

Ingenious ship flat, fold-up, self-standing literature holder that saves inventory space and eliminates breakage. Attractively showcase tri-fold pamphlets or brochures. Sits stable as a freestanding holder on tops of tables, shelves, desks or counters. Slant back, single pocket design ensures that literature remains upright.

- Holds literature up to 4-1/8" wide
- Wide backside easel design for increased stability
- Base measures 3-1/4" when snapped together via a few simple folds – instructions included with each part
- Also can be wall mounted via two backside hole options: one slotted hole and one keyhole
- Frontside is notched for improved visibility
- .070" - .080" rigid material thickness
- Clear K-Resin material



ITEM #	WIDTH	BACK HEIGHT	DEPTH
150130	4-1/8"	7"	1-5/8"

Fold-Up Easel Back Literature Box

Makes brochures stand up and get noticed. Ingenious ship flat, fold-up, self standing literature holder/protector for countertop display. Much less expensive than solid acrylic tri-fold brochure holders. Box assembles easily by locking into position with integrated double-tabs. Full 20 mil thickness is stronger than thinner imitations.

- Die-impressed score lines easily fold into place
- Holds 4" wide brochures
- 4-1/16" wide x 1-1/4" deep x 5" front height and 6-1/4" back height
- 20 mil thick, clear rigid PVC material

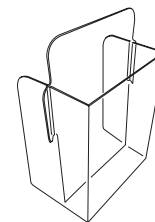

ITEM #	ASSEMBLED WIDTH	ASSEMBLED OVERALL HEIGHT
150122	4-1/16"	6-1/4"

Warehouse Upright Adapter

Designed to securely attach signs, flush displays or fold-up literature boxes directly onto common upright slots found in warehouse pallet racking. Simply peel and stick the pre-applied adhesive strip to the back side, flat surface of most literature holders – then, flexibly engage the two wings into the teardrop shaped holes found on standard retail warehouse uprights.

- Flexible mounting wings are 1-5/8" on center
- Fits most standard warehouse pallet racking with teardrop style holes
- .050" (50 mil) thick natural high density polyethylene

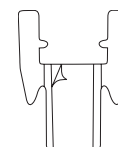

ITEM #	WIDTH	HEIGHT
150155	2"	2-1/2"

Single-Pocket Winged Back Literature Holder

Attractively showcase literature, pamphlets or brochures. Sits as a freestanding holder on tables, shelves, desks or counters. Winged-back, single-pocket design ensures that literature remains upright.

- Holds literature up to 4" wide
- Frontside is notched for improved visibility
- Bottom of pocket has ridges to keep literature from sliding
- Deluxe .080" thick plastic
- Crystal clear styrene

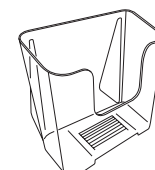

ITEM #	WIDTH	BACK HEIGHT	DEPTH
150131	4-3/8"	3-7/8"	1-5/8"

Single-Pocket Winged Back Literature Holder With Hole

Attractively showcase literature, pamphlets or brochures. Sits as a freestanding holder on tables, shelves, desks or counters, or can be mounted to a wall or other fixtures using the built-in hole (fasteners sold separately). Winged-back, single-pocket design ensures that literature remains upright.

- Holds literature up to 4" wide
- Frontside is notched for improved visibility
- Bottom of pocket has ridges to keep literature from sliding
- Built-in mounting hole adds versatility
- Deluxe .080" thick plastic
- Crystal clear styrene

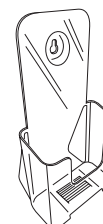

ITEM #	WIDTH	BACK HEIGHT	DEPTH
150132	4-3/8"	7-3/4"	1-5/8"

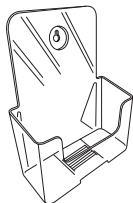

Extra-Large Winged Back Literature Holder With Hole

Attractively showcase larger, thicker literature. Sits as a freestanding holder on tables, shelves, desks or counters, or can be mounted to a wall or other fixtures using the built-in hole (fasteners sold separately). Winged-back, single-pocket design ensures that literature remains upright.

- Holds literature up to 6-3/8" wide
- Frontside is notched for improved visibility
- Bottom of pocket has ridges to keep literature from sliding
- Built-in mounting hole adds versatility
- Deluxe .080" thick plastic
- Crystal clear styrene



ITEM #	WIDTH	BACK HEIGHT	DEPTH
150137	6-3/4"	7-3/4"	2"

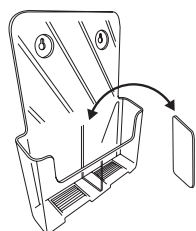

Two-Way Winged Back Literature Holder

Display literature two different ways: Either one long pocket or two smaller pockets. This freestanding literature holder features a handy, slide-in divider. Keep the divider in place to have two separate pockets, or simply remove the divider and use the entire length at once. Sits as a freestanding holder, or can be mounted to a wall or other fixtures using the built-in holes (fasteners sold separately). Winged-back design ensures that literature remains upright.

- With divider in place, hold literature up to 4-1/4" wide
- With divider removed, hold literature up to 9" wide
- Frontside is notched for improved visibility
- Bottom of pocket has ridges to keep literature from sliding
- Built-in mounting holes add versatility
- Deluxe .080" thick plastic
- Crystal clear styrene



ITEM #	WIDTH	BACK HEIGHT	DEPTH
150138	9-3/8"	10-3/4"	1-1/2"



Two-Level Winged Back Brochure Holder

Two separate levels showcase tri-fold literature, pamphlets or brochures. Place as a freestanding holder, or mount to a wall or other fixtures using two built-in holes (fasteners sold separately). Winged back allows a slightly angled view. Unit is one solid, clear piece that requires no assembly.

- Holds literature up to 4-1/8" wide
- Front pocket is 1-1/8" deep and 4-1/2" tall
- Back pocket is 1-1/4" deep and 4-3/4" tall
- Level 2 is 1-1/2" higher than Level 1
- Bottom of pockets have ridges to keep literature from sliding
- Built-in mounting holes add versatility
- Deluxe .080" thick plastic
- Both front sides are notched for improved visibility
- Crystal clear styrene



ITEM #	WIDTH	BACK HEIGHT	LEVELS
150134	4-5/8"	8-1/4"	2 Levels

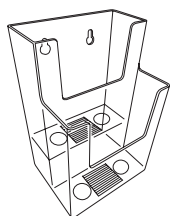

Two-Level Brochure Holder

Two separate levels showcase tri-fold literature, pamphlets or brochures. Place as a freestanding holder, or mount to a wall or other fixtures using two built-in holes (fasteners sold separately). Unit is one solid, clear piece that requires no assembly.

- Holds literature up to 4-1/4" wide
- Front pocket is 1-1/2" deep and 4-3/4" tall
- Back pocket is 1-3/4" deep and 4-7/8" tall
- Level 2 is 2" higher than Level 1
- Bottom of pockets have ridges to keep literature from sliding
- Built-in mounting holes add versatility
- Deluxe .080" thick plastic
- Both front sides are notched for improved visibility
- Crystal clear styrene



ITEM #	WIDTH	BACK HEIGHT	LEVELS
150133	4-5/8"	7"	2 Levels

Sign & Literature Holders

Three-Level Brochure Holder

Three separate levels showcase tri-fold literature, pamphlets or brochures. Place as a freestanding holder, or mount to a wall or other fixtures using two built-in holes (fasteners sold separately). Unit is one solid, clear piece that requires no assembly.

- Holds literature up to 4-1/4" wide
- Each pocket is 1-5/8" deep and 4-7/8" tall
- Levels 2 and 3 are each 2" higher than the one before
- Bottom of pockets have ridges to keep literature from sliding
- Built-in mounting holes add versatility
- Deluxe .080" thick plastic
- All three front-sides are notched for improved visibility
- Crystal clear styrene

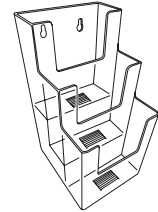

ITEM #	WIDTH	BACK HEIGHT	LEVELS
150831	4-5/8"	9"	3 Levels

Four-Level Brochure Holder

Four separate levels showcase tri-fold literature, pamphlets or brochures. Place as a freestanding holder, or mount to a wall or other fixtures using two built-in holes (fasteners sold separately). Unit is one solid, clear piece that requires no assembly.

- Holds literature up to 4-1/8" wide
- All pockets are 5-1/2" tall and at least 1" deep
- Levels 2, 3 and 4 are 1-1/2" higher than the one before
- Bottom of pockets have ridges to keep literature from sliding
- Built-in mounting holes add versatility
- Deluxe .070" to .090" thick plastic
- All four front-sides are notched for improved visibility
- Crystal clear styrene

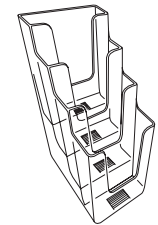

ITEM #	WIDTH	BACK HEIGHT	LEVELS
150135	4-3/4"	10"	4 Levels

Freestanding Sign Holder With Pocket

Combine "take one" service with quality literature presentation. Clear, freestanding easel showcases a standard 8-1/2" x 11" sign with an attached pocket for additional literature for taking. Easel style presents a highly visible viewing angle on counters, tables and shelves.

- Features integrated thumb notch for easy sign removal
- Pocket is 4" wide x 4-3/8" high x 1" deep
- Deluxe .070" thick styrene
- Crystal clear styrene material

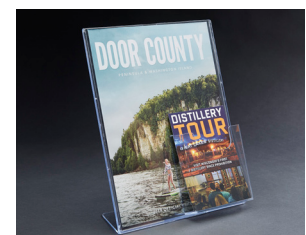
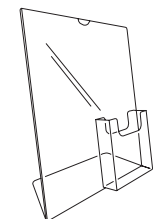

ITEM #	SIGN SIZE	POCKET SIZE	STYLE
109556	8-1/2" Width x 11" Height	4" Width x 4-3/8" Height x 1" Depth	Portrait

T-Style Sign Holder With Pocket

Combine "take one" service with quality literature presentation. Clear, freestanding "T-style" sign frame showcases an 11" x 14" sign with an attached pocket for additional literature for taking. Ideal for anywhere flyers or brochures are offered.

- Loads from the side or bottom
- Pocket is 4-1/2" wide x 5" high x 1" deep
- Deluxe .110" thick material
- Crystal clear styrene

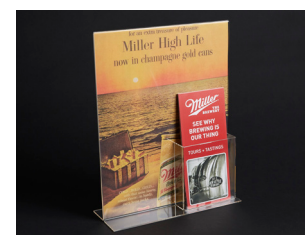
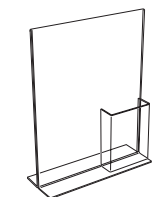

ITEM #	SIGN SIZE	POCKET SIZE	STYLE
150810	11" W x 14" H	4-1/2" W x 5" H x 1" D	Portrait

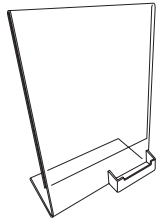

Freestanding Sign Holder With Business Card Pocket

Combine “take one” service with quality literature presentation. Clear, freestanding easel showcases a standard 8-1/2" x 11" sign with an attached pocket for business cards for taking. Easel style presents a highly visible viewing angle on counters, tables and shelves.

- Pocket is 3-5/8" wide x 7/8" high x 3/4" deep
- Displays up to 40 business cards
- Deluxe .070" thick plastic
- Crystal clear styrene



ITEM #	SIGN SIZE	POCKET SIZE	STYLE
150139	8-1/2" Width x 11" Height	3-5/8" Width x 7/8" Height x 3/4" Depth	Portrait

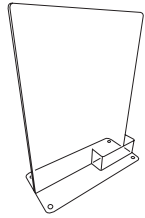

T-Style Sign Holder With Business Card Pocket

Combine “take one” business cards with quality literature presentation. Clear, freestanding T-style base showcases a standard 8-1/2" x 11" sign with an attached pocket for business cards or additional literature for taking. Offers a direct viewing angle on counters, tables and shelves.

- Signs drop in easily from above, and can be changed easily
- T-style base is 3-7/8" wide for stability
- Pocket holds a standard business card or other literature
- Crystal clear styrene material



ITEM #	SIGN SIZE	POCKET SIZE	STYLE
150833	8-1/2" Width x 11" Height	3-1/2" Width x 1-1/4" Height x 1" Depth	Portrait

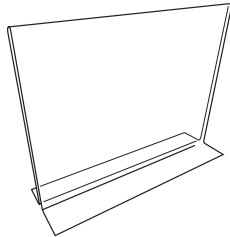

T-Style Bottom-Load Sign Holder

Drive customer attention to graphics and promotional literature with this clear, self-standing “T-style” sign holder. Attractively display signs on counters, tables and shelves.

- Can be viewed from either direction
- Loads easily from the bottom or side
- T-style base is 3-1/4" wide for stability
- Deluxe .070" thick plastic
- Crystal clear acrylic



	ITEM #	SIGN SIZE	STYLE
	150145	11" Width x 8-1/2" Height	Landscape
NEW	150841	9" Width x 12" Height	Portrait

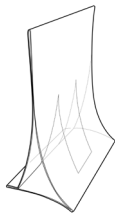

Slantback Fold-Up Sign Holder

Ingenious ship flat, fold-up, self standing sign holder/protector. Specifically designed to reduce damage and cost during shipment as compared to common acrylic sign holders. Sleek and crystal clear – perfect for attractively displaying signs on counters, tables and shelves. Side or bottom load signs for easy insertion and removal.

- Available in portrait and landscape styles
- Accepts sign materials up to 1/32" thick
- Other sizes made to order
- Custom imprinting available – please inquire
- 30 mil thick, clear rigid PVC material



	ITEM #	SIGN SIZE	STYLE
	150165	5-1/2" Width x 7" Height	Portrait
	150166	8-1/2" Width x 11" Height	Portrait
	150167	7" Width x 5-1/2" Height	Landscape
	150168	11" Width x 8-1/2" Height	Landscape

Acrylic Slantback Sign Holder

Drive customer attention to graphics and promotional literature with these self-standing sign holders/protectors. Perfect for attractively displaying signs on counters, tables and shelves. Borderless slant back frame design provides quick side change and long lasting performance.

- Deluxe .070" - .080" thick virgin acrylic
- Side load signs quickly and easily
- Slightly tilted for improved visibility
- Designed for one sided viewing
- Custom imprinting and other sizes/styles available – please inquire
- Crystal clear acrylic material

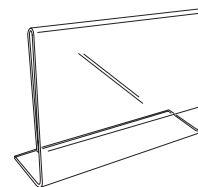

ITEM #	SIGN SIZE	STYLE
150234	4" Width x 6" Height	Portrait
150801	5-1/2" Width x 3-1/2" Height	Landscape
150802	7" Width x 5-1/2" Height	Landscape
150803	8-1/2" Width x 11" Height	Portrait
150805	11" Width x 7" Height	Landscape
NEW 150825	11" Width x 7" Height	Landscape w/ Elongated Base
150808	11" Width x 8-1/2" Height	Landscape

Acrylic Top-Load Sign Holder

Drive customer attention to graphics and promotional literature with these clear, self-standing "Y-style" sign holders. Attractively display signs on counters, tables and shelves.

- Can be viewed from either direction
- Loads easily from the side or top
- Deluxe .070" thick material
- Additional sizes available – please inquire
- Crystal clear acrylic



ITEM #	SIGN SIZE	STYLE
150822	4" Width x 5-1/2" Height	Portrait
NEW 150837	5-1/2" Width x 7" Height	Portrait
150143	8-1/2" Width x 11" Height	Portrait
150144	11" Width x 8-1/2" Height	Landscape

Easel Back Sign Holder

Easels are an easy, inexpensive way to make P.O.P. signs and displays stand up and get noticed. Can also be used to add signage to any flat surface. No messy glue required, as the removable clear plastic cover both contains and protects the signs. Ships flat and then folds open for an easy assembly.

- Double wing design for increased freestanding stability
- To assemble, simply fold out wings and bend down the support tab
- White easel back display board with 10 mil clear plastic cover
- Other sizes and colors available – please inquire
- Packaged 5 per bag



ITEM #	SIGN SIZE	STYLE
107405	8-1/2" Width x 11" Height	Portrait
107406	11" Width x 14" Height	Portrait

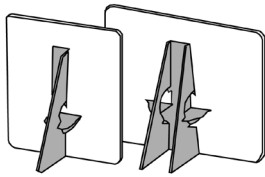

Self-Sticking Cardboard Easel

Easels are an easy, inexpensive way to make P.O.P. signs and displays stand up and get noticed. Available in two styles: single-wing for normal applications, or double-wing to give increased stability to taller, heavier sign boards. No messy glue required.

- Mounting adhesive strip attached
- 35 point (.035" thick) SBS board material



ITEM #	HEIGHT	STYLE	COLOR
107400	5"	Single-Wing	White
107400B	5"	Single-Wing	Black
107401	7"	Single-Wing	White
107401B	7"	Single-Wing	Black
107402	7"	Double-Wing	White
107402B	7"	Double-Wing	Black
107403	12"	Double-Wing	White
107403B	12"	Double-Wing	Black

Please note: Display boards are not included.

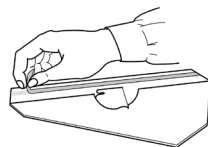

1. Peel off backing to expose adhesive

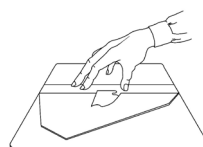

2. Press easel onto center of display board

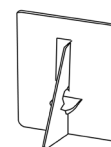

3. Fold out wing & bend down support tab

Sign & Literature Holders

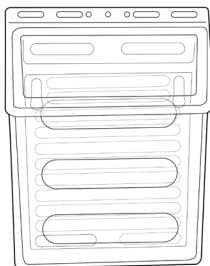

Take-One Outdoor Literature Holder

Versatile vacuum-formed holder that keeps literature, brochures and flyers protected and easily accessible. Hinged top flap simply snaps on and allows for easy restocking/removal of material. Two popular sizes to choose from: the small is for half-fold and tri-fold sheets while the large is for standard full sheets (not legal size). **Patented.**

- For both indoor and outdoor use
- Pre-punched hanging holes at top and bottom
- Clear PETG material
- Included with each literature holder: two .178" wide (50# tensile) x 11" long natural nylon cable ties; two #10 x 3/4" long Phillips pan head steel zinc plated sheet metal screws; and one red lettered "Take One" sticker
- Can also be mounted with double-sided tape or suction cups (sold separately)



ITEM #	WIDTH	HEIGHT	DEPTH	SIZE
150150	5-1/2"	9-1/4"	1-1/2"	Small
150151	9"	11-3/4"	1-1/8"	Large



Mounting hardware included

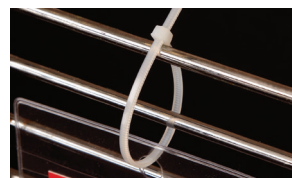

If you need different length Cable Ties than the two 11" long straps included, additional Locking Straps can be purchased separately (see page 202).



Suction cups sold separately (see page 162-163)

K-Frame. In-store impact. **Solved.**

Focus consumer attention on the products and promotions that drive your business with K-Frame, the elegant, modular and cost-effective new signage framing solution from Kinter. K-Frame is available in a wide variety of sizes and configurations to accommodate just about every possible signage need. It installs in a snap and is made to last. Ask a KinterCare Representative about all of the framing options and related mounting accessories available.



For your FREE K-Frame Sample Kit, go to kframe.com or call 800.323.2389.



For more information, go to kframe.com

K-Frames

Elegant, round cornered two-sided sign frame that is both interchangeable and versatile. In-store advertising made cost-effective when snapped into any one of a variety of K-Frame base choices (all bases sold separately). Can be used in either portrait (vertical) or landscape (horizontal) orientation and repositioned as needed. Signs are framed evenly on all four sides by an attractive 15/32" wide border.

- Choose the frame that is right for your application
- Secure friction fit design with no tools required
- Accepts signs up to .110" thick
- Compatible with all K-Frame holder system components
- Custom sizes and colors available – please inquire
- White or black plastic material
- Packaged 5 per bag

ITEM #	SIGN SIZE	FRAME OPENING	STYLE	COLOR
150180	4-1/2" x 4-1/2"	on 4-1/2" Side	Portrait or Landscape	White
150184	5-1/2" x 3-1/2"	on 3-1/2" Side	Portrait or Landscape	White
150184B	5-1/2" x 3-1/2"	on 3-1/2" Side	Portrait or Landscape	Black
150179	7" x 5-1/2"	on 5-1/2" Side	Portrait or Landscape	White
150179B	7" x 5-1/2"	on 5-1/2" Side	Portrait or Landscape	Black
150181	8-1/2" x 5-1/2"	on 5-1/2" Side	Portrait or Landscape	White
150181B	8-1/2" x 5-1/2"	on 5-1/2" Side	Portrait or Landscape	Black
150182	11" x 7"	on 7" Side	Portrait or Landscape	White
150182B	11" x 7"	on 7" Side	Portrait or Landscape	Black
150183	11" x 8-1/2"	on 8-1/2" Side	Portrait or Landscape	White





K-Frame Suction Cup Holders

- Ideal for windows or glass doors; Patent Pending
- Compatible with all plastic K-Frames in flag or flush position (sold separately)
- Adapter is clear PVC; suction cup is clear UV-resistant flexible PVC

ITEM #	CUP DIAMETER	STYLE	SIGN POSITION
107066	1-3/4"	Portrait or Landscape	Flag
107062	1-3/4"	Portrait or Landscape	Flush



K-Frame Wall Mount Holder Kit

- Mounts to wall surfaces such as drywall, concrete, wood or brick; Patent Pending
- Compatible with all plastic K-Frames in flush position (sold separately)
- Adapter is clear PVC; screws are #10 x 1" long with a Slotted/Phillips combo head

ITEM #	CONTENTS	STYLE
106140	Two Adapters, Two Wall Anchors and Two Screws	Portrait or Landscape

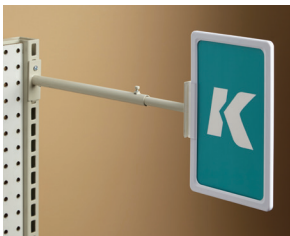

K-Frame Telescopic Aisle Holders

- Fits into standard gondola uprights or pegboard; Patent Pending
- Compatible with all plastic K-Frames in flag position (sold separately)
- Telescoping arm adjusts from 13" to 21" long in 1" increments
- Base is beige painted steel

ITEM #	FOR USE ON	TYPE	STYLE
106907	Gondola Uprights	With Hinge	Portrait or Landscape
106908	Gondola Uprights	No Hinge	Portrait or Landscape
106997	Gondola Uprights (Tool-Free)	With Hinge	Portrait or Landscape
106998	Gondola Uprights (Tool-Free)	No Hinge	Portrait or Landscape
106927	Pegboard	With Hinge	Portrait or Landscape
106928	Pegboard	No Hinge	Portrait or Landscape



K-Frame Gondola Upright Holder

- Fits into most standard gondola uprights; Patent Pending
- Compatible with all plastic K-Frames in flag position (sold separately)
- Base is white ABS material

ITEM #	TYPE	STYLE
106307	With Hinge	Portrait or Landscape
106308	No Hinge	Portrait or Landscape



K-Frame Pegboard Holder

- Fits into most standard pegboard holes; Patent Pending
- Compatible with all plastic K-Frames in flag position (sold separately)
- Base is white ABS material

ITEM #	TYPE	STYLE
106507	With Hinge	Portrait or Landscape
106508	No Hinge	Portrait or Landscape

K-Frame Warehouse Upright Holder

- Fits into most teardrop-shaped holes (not square or round) found on standard warehouse uprights; Patent Pending
- Compatible with all plastic K-Frames in flag position (sold separately)
- Base is white ABS material

ITEM #	TYPE	STYLE
106207	With Hinge	Portrait or Landscape
106208	No Hinge	Portrait or Landscape



K-Frame Shelf-Top Holders

- Fits into and hangs over most perforated shelves; Patent Pending
- Compatible with all plastic K-Frames in flag position (sold separately)
- Base is beige ABS (1 shelf prong) or beige painted steel (2 shelf prongs)

ITEM #	MATERIAL	TYPE	STYLE
106407	ABS	With Hinge	Portrait or Landscape
106408	ABS	No Hinge	Portrait or Landscape
106807	Steel	With Hinge	Portrait or Landscape
106808	Steel	No Hinge	Portrait or Landscape



K-Frame Channel Mount Holders

- Fits into most standard 1-1/4" shelf price channels by turning an included screw; Patent Pending
- Compatible with all plastic K-Frames in flag position (sold separately)
- Base is beige ABS or beige painted spring steel

ITEM #	MATERIAL	TYPE	STYLE
106607	ABS	With Hinge	Portrait or Landscape
106608	ABS	No Hinge	Portrait or Landscape
106627	Spring Steel	With Hinge	Portrait or Landscape
106628	Spring Steel	No Hinge	Portrait or Landscape



K-Frame Adhesive Holders

- Adhesive bottom adheres to any clean, flat surface; Patent Pending
- Compatible with all plastic K-Frames in flag or flush position (sold separately)
- Tape is high-tack acrylic adhesive that reaches maximum strength in 24 hours
- Clear PVC

ITEM #	TYPE	SIGN POSITION
106117	With Hinge	Flag
106118	No Hinge	Flag
106119	No Hinge	Flush



K-Frame "C" Clamp Aisle Holder

- "C" clamp design ideal for square edges of shelves or fixtures; Patent Pending
- Compatible with all plastic K-Frames in flag position (sold separately)
- Fits shelves or fixtures up to 2-1/2" thick
- Base is zinc plated steel

ITEM #	TYPE	STYLE
106937	With Hinge	Portrait or Landscape
106938	No Hinge	Portrait or Landscape





K-Frame Under-Shelf Holders

- Mounts underneath most perforated shelves and adds signs from below; Patent Pending
- Compatible with all plastic K-Frames in flag position (sold separately)
- Base is beige painted spring steel

ITEM #	ATTACHMENT	TYPE	STYLE
106707	Spring-Mount	With Hinge	Portrait or Landscape
106708	Spring-Mount	No Hinge	Portrait or Landscape
106917	Screw-Mount (Screw Included)	With Hinge	Portrait or Landscape
106918	Screw-Mount (Screw Included)	No Hinge	Portrait or Landscape



K-Frame Under-Shelf Hardware-Mount Holder

- Locks underneath most perforated shelves using wing nuts and screws (included) and adds signs from below; Patent Pending
- Compatible with all plastic K-Frames in flag position (sold separately)
- Base is beige painted steel

ITEM #	TYPE	STYLE
106947	With Hinge	Portrait or Landscape
106948	No Hinge	Portrait or Landscape



K-Frame Magnetic Under-Shelf Holder

- Magnetic base mounts underneath metal shelves and adds signs from below; Patented & Patent Pending
- Compatible with all plastic K-Frames in flag position (sold separately)
- Base is ABS material

ITEM #	TYPE	STYLE	COLOR
106967	With Hinge	Portrait or Landscape	Beige
106967B	With Hinge	Portrait or Landscape	Black
106968	No Hinge	Portrait or Landscape	Beige
106968B	No Hinge	Portrait or Landscape	Black



K-Frame Magnetic Under-Shelf L-Style Holder

- Magnetic base mounts underneath metal shelves and adds signs from below (parallel to the shelf); Patent Pending
- Compatible with all plastic K-Frames in flag position (sold separately)
- Base is beige ABS material

ITEM #	TYPE	STYLE
106977	With Hinge	Portrait or Landscape
106978	No Hinge	Portrait or Landscape



K-Frame Magnetic Holders

- Magnetic base is ideal for warehouse racks, shelf gondolas and freezer cases; Patent Pending
- Compatible with all plastic K-Frames in flag or flush position (sold separately)
- 7/8" wide x 1/4" height nickel-plated steel casing containing ceramic magnets

ITEM #	TYPE	STYLE	SIGN POSITION
107067	With Hinge	Portrait or Landscape	Flag
107068	No Hinge	Portrait or Landscape	Flag
107069	No Hinge	Portrait or Landscape	Flush

K-Frame Adjustable Magnetic Rotating Holder

- Ratcheting magnetic base allows the display of signs at optimal positions from metal surfaces with the push of a button
- Compatible with all plastic K-Frames (sold separately)
- Adapter tops rotates 360 degrees
- White magnetic base is 1-1/2" wide x 2-3/4" long



ITEM #	OVERALL HEIGHT	COLOR
150198	4-1/8"	White

K-Frame Magnetic Shelf-Top Holder

- Heavy-duty magnetic base mounts to shelves, gondolas or other metal surfaces; Patent Pending
- Compatible with all plastic K-Frames in flag position (sold separately)
- Base is white ABS material



ITEM #	TYPE	STYLE
106787	With Hinge	Portrait or Landscape
106788	No Hinge	Portrait or Landscape

K-Frame Shovel Base

- Rectangular, low-profile shovel base slips under boxes or products
- Compatible with all plastic K-Frames (sold separately)
- Features two .250" holes spaced 4" apart (on center) for optional mounting
- Clear PVC

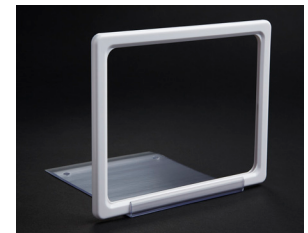

ITEM #	SIZE	COLOR
150112	4-3/4" Wide x 5-1/2" Long	Clear

K-Frame Shovel Bases With Adjustable Stem

- Freestanding, flat base slips under boxes or products
- Compatible with all plastic K-Frames
- Round telescopic stem adjusts from 12" to 22" height
- Must be ordered in multiples of 5



ITEM #	SIGN SIZE	BASE	STYLE
150185	8-1/2" x 5-1/2" (Frame Included)	Round (7" O.D.)	White
150186	11" x 8-1/2" (Frame Included)	Round (7" O.D.)	White
150199	Frame Sold Separately	Rectangular (4-3/4" x 8-5/8")	White
150199B	Frame Sold Separately	Rectangular (4-3/4" x 8-5/8")	Black

K-Frame Telescopic Clip-On Holder

- Heavy-duty spring clip is lined with anti-slip coating and attaches to fixtures up to 2" thick
- Telescopic stem extends and rotates 360 degrees
- Compatible with all plastic K-Frames (sold separately)
- White plastic



ITEM #	ADJUSTABLE STEM	COLOR
150316	15" to 21"	White



K-Frame Clip-On Rotating Thumb Sign Holder

- Heavy-duty spring clip is lined with anti-slip white foam tape and offers an “easy pivot” thumb lever
- Rotates 360 degrees and attaches to fixtures up to 1-1/2" thick
- Compatible with all plastic K-Frames (sold separately)
- White ABS material

ITEM #	OVERALL HEIGHT	COLOR
150321	5-1/2"	White

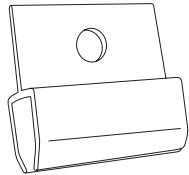

K-Frame Hanger Clip

- Hanging adapter provides a simple K-Frame connection point; Patent Pending
- Compatible with all plastic K-Frames (sold separately)
- Center hole accommodates hooks, rings, pear clips and more
- Clear PVC

ITEM #	WIDTH	HOLE DIAMETER
106095	1-1/4"	.250"



K-Frame Wire Flush Hanger Clip

- Hang signs in flush position from wire grids, baskets and front fences; Patent Pending
- Compatible with all plastic K-Frames in flush position (sold separately)
- Clear PVC

ITEM #	WIDTH	MAX. WIRE DIAMETER
106098	1-1/4"	up to 3/8"

Sign & Literature Holders



Display Construction



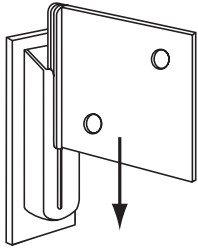

Shelf Support Clips

Makes corrugated assembly easy and saves on shipping costs. Prior to shipping corrugated displays, two piece shelf support clips allow for pre-attachment of “knock-down” sections. Male parts have holes for glue seep through and female parts have snap-lock features. **Warning:** Parts are designed to be used vertically and are not recommended for horizontal use.

- Male and female parts sold separately and in equal quantities only
- Fits up to 3/16" (C-Flute) corrugated
- Polypropylene material
- Also available in other colors – please inquire



ITEM #	STYLE	SIZE	HEIGHT	LENGTH	COLOR
107140	Male	Small	1-7/8"	2-1/4"	White
107140B	Male	Small	1-7/8"	2-1/4"	Black
107141	Female	Small	1-7/8"	n/a	White
107141B	Female	Small	1-7/8"	n/a	Black
107142	Male	Large	2-3/8"	2-1/4"	White
107143	Female	Large	2-3/8"	n/a	White



#107140 is also available with our Modular Display Pole Shelf Support (see page 199)

Display Construction

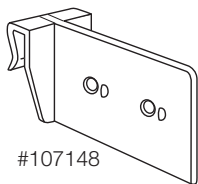

#107148

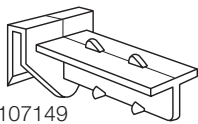

#107149

Clip-On Corrugated Shelf Supports

Use to securely support corrugated shelves within displays. The vertical style is for light to medium weight applications and the horizontal style is for heavier applications. The vertical style has side holes for glue seep through and the horizontal style has tapered teeth that bite into corrugated.

- Fits up to 1/8" (B-Flute) corrugated
- Natural polypropylene material
- Packaged 50 per bag

ITEM #	STYLE	STRENGTH	LENGTH
107148	Vertical	Standard	2-1/4"
107149	Horizontal	Heavy Duty	2"

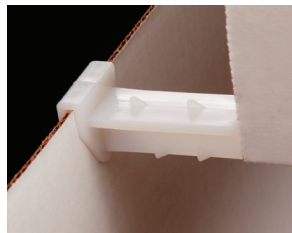

Corrugated Shelf Support Inserts

Offers quick and easy installation of corrugated shelves while securely holding shelf in place – no glue required. Simply insert the clip into a corrugated cut-out, slide the insert into place and slip the edge of the shelf over the capture leg – it's that simple.

- 1-1/2" wide x 2-1/4" overall length
- Single capacity holds 1/8" (B-Flute) shelf construction & 1/8" display wall for a total of 1/4"
- Double capacity holds doubled thickness 1/8" (B-Flute) shelf construction & 1/8" display wall for a total of 3/8"
- Clear PVC material

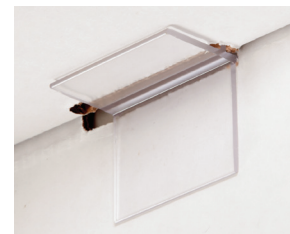
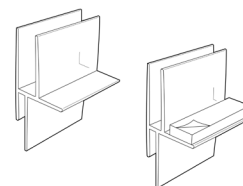

ITEM #	CAPACITY	STYLE
107156	1/4" Single	No Adhesive
107158	1/4" Single	With Adhesive
107157	3/8" Double	No Adhesive

Insertion Steps:



Heavy Duty Corrugated Shelf Support Inserts

Angled support tube styled bottom offers more strength for heavier shelves. Easy installation with no glue required. Simply insert the clip into a corrugated cut-out, slide the insert into place and slip the edge of the shelf over the capture leg – it's that simple.

- 1-1/2" wide x 2-1/4" overall length
- Angled support for heavier applications
- Single capacity holds 1/8" (B-Flute) shelf construction & 1/8" display wall for a total of 1/4"
- Double capacity holds doubled thickness 1/8" (B-Flute) shelf construction & 1/8" display wall for a total of 3/8"
- Clear PVC material

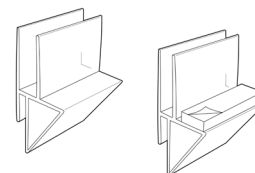

ITEM #	CAPACITY	STYLE
107159	1/4" Single	No Adhesive
107161	1/4" Single	With Adhesive
107160	3/8" Double	No Adhesive

Insertion Steps:

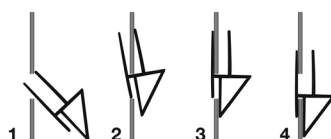

Corrugated Edge Molding

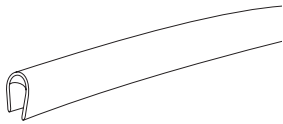

Flexible plastic trim designed to give a beautiful finished appearance to corrugated display edging. Pre-glued, pressure sensitive adhesive within the channel assures a secure fit even around irregularly shaped or rounded edges. Attractively cover unfinished edges while assuring customer safety from possible paper cuts. Quick and easy installation.



- 5/16" U-shaped overall height designed to fit 1/8" (B-Flute) corrugated
- Bright chrome has a decorative mylar finish
- Other colors, finishes or special lengths available – please inquire
- Flexible vinyl material
- Packaged in continuous 500 foot long rolls
- Sold in full rolls only

ITEM #	COLOR	ROLL QUANTITY
150625	Bright Chrome	500 feet
150625W	White	500 feet
150625B	Black	500 feet

Flute Wire

An inexpensive way to form or support corrugated displays, die cuts or headers. Use to keep weaker display sections from bending or breaking over. Add signs above displays or to join two or more displays together. If shipping larger folded signs or scored headers, Flute Wires are a great way to re-assemble as rigid.

- Slides inside the fluting of common corrugated materials and holds a bend as needed
- For use in either B or C Flute corrugate
- Other Flute sizes/diameters and lengths available – please inquire
- Bright galvanized, zinc coated metal

ITEM #	FITS INSIDE	WIRE GAUGE	LENGTH
108070	B-Flute	.072" dia. (15 ga.)	6"
108071	B-Flute	.072" dia. (15 ga.)	12"
108072	B-Flute	.072" dia. (15 ga.)	24"
108073	C-Flute	.080" dia. (14 ga.)	6"
108074	C-Flute	.080" dia. (14 ga.)	12"
108075	C-Flute	.080" dia. (14 ga.)	24"



Kinter is proud to have our campus headquarters located in Waukegan, IL.

Packaging Handles

Several packaging handle sizes to choose from for lightweight to heavy applications. All purpose plastic handles for every application. Used widely in box cartons, packaging, electronics and luggage goods. Backer washers (a.k.a. support plates) also offered for added durability.

- Flexible strength for ease of insertion
- Backer washers are 1-3/8" O.D. x .531" thick and work with all styles of our handles
- Other sizes, strengths and colors available – please inquire
- Black or white low density polyethylene material

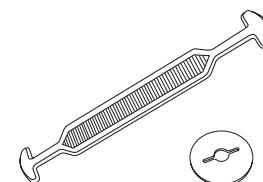

ITEM #	SIZE	STYLE	WEIGHT CAPACITY	COLOR
109522	6" long	Light Duty Handle	up to 15 lbs.	White
109522B	6" long	Light Duty Handle	up to 15 lbs.	Black
109523	6-1/2" long	Medium Duty Handle	up to 30 lbs.	White
109524B	6-1/4" long	Heavy Duty Handle	up to 45 lbs.	Black
109525	1-3/8" O.D.	Round Backer Washer	n/a	White



Backer washers sold separately

Pallet Display Clip

Ideal for securely joining corrugated pallet drop bins and bulk merchandising displays together. No adhesive required. Heavy duty grip connects panel edges or fits 2" wide slots in corrugated display panels.

- Accepts material up to 3/8" thick
- Custom lengths available
- Clear PVC material

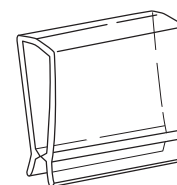

ITEM #	WIDTH	LENGTH	DEPTH
107120	2"	2"	7/16"



Kinter began in 1980 as a standard nut & bolt distributor. Today we're a full line fastener distributor, stocking over 30,000 different & specialty fasteners.

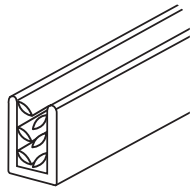

Gripper "U" Channel Panel Former

Mount on sign edges for a clean, finished look. Gripper fins hold sign and display materials straight and secure. Engineered for a wide range of applications.

- 9/16" height
- 48" long
- Custom lengths available
- Clear or white PVC material
- Custom colors available

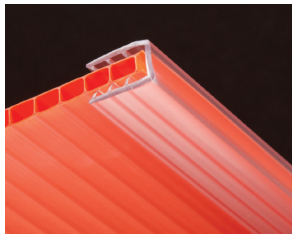

ITEM #	SIZE	BASE WIDTH	GRIP CAPACITY	COLOR
108537	Standard	3/8"	1/8" to 3/16"	Clear
108537W	Standard	3/8"	1/8" to 3/16"	White
108538	Heavy Duty	13/32"	3/16" to 1/4"	Clear
108538W	Heavy Duty	13/32"	3/16" to 1/4"	White

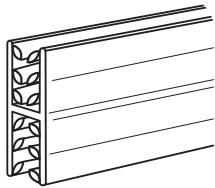

Gripper 180 Degree "H" Panel Former

Gripper fins hold and join two sign panel edges securely at a fixed 180 degrees. Can be used in both vertical or horizontal positions for a clean, flat finish.

- 1" overall height
- 48" long
- Custom lengths available
- Clear or white PVC material
- Custom colors available

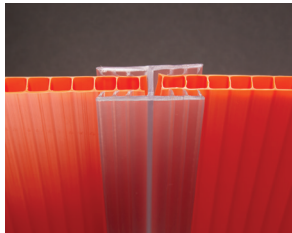

ITEM #	SIZE	GRIP CAPACITY	COLOR
108557	Standard	1/8" to 3/16"	Clear
108557W	Standard	1/8" to 3/16"	White
108558	Heavy Duty	3/16" to 1/4"	Clear
108558W	Heavy Duty	3/16" to 1/4"	White

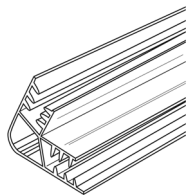

Gripper 60 Degree Panel Former

Gripper fins hold and join two sign panel edges securely at fixed 60 degree angles. Plastic piece also conceals unfinished sign edges.

- Two grip sizes available
- Both parts have 7/8" height 60 degree angles
- 48" length
- Custom lengths available
- Clear or white PVC material
- Custom colors available

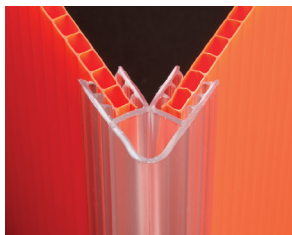

ITEM #	SIZE	GRIP CAPACITY	COLOR
108615	Standard	1/8" to 3/16"	Clear
108615W	Standard	1/8" to 3/16"	White
108616	Heavy Duty	3/16" to 1/4"	Clear
108616W	Heavy Duty	3/16" to 1/4"	White

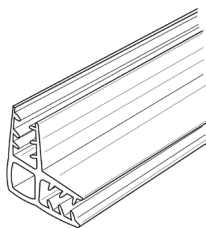

Gripper 90 Degree Panel Former

Gripper fins hold and join two sign panel edges securely at fixed 90 degree angles. Corner piece also conceals unfinished sign edges.

- Two grip sizes available
- Both parts have 7/8" height right angles
- 48" length
- Custom lengths available
- Clear or white PVC material
- Custom colors available

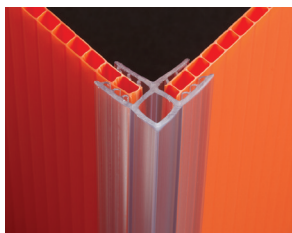

ITEM #	SIZE	GRIP CAPACITY	COLOR
108603	Standard	1/8" to 3/16"	Clear
108603W	Standard	1/8" to 3/16"	White
108604	Heavy Duty	3/16" to 1/4"	Clear
108604W	Heavy Duty	3/16" to 1/4"	White

Hinged Gripper Concealed Panel Former

Gripper fins hold sign or display panels securely in multiple angle positions while at the same time concealing unfinished panel edges. The clear former blends into displays of any color.

- Two 1/2" height "U" channels joined by a flexible hinge
- Two grip sizes available
- 48" length
- Custom lengths available
- Clear or white PVC material
- Custom colors available

ITEM #	SIZE	GRIP CAPACITY	COLOR
108670	Standard	1/8" to 3/16"	Clear
108670W	Standard	1/8" to 3/16"	White
108671	Heavy Duty	3/16" to 1/4"	Clear
108671W	Heavy Duty	3/16" to 1/4"	White

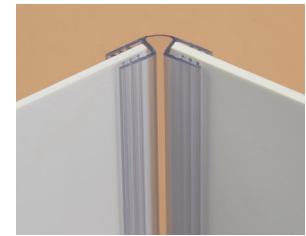
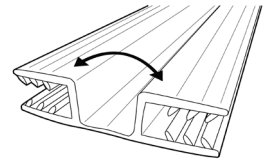

Hinged Gripper Panel Former

Gripper fins hold sign or display panels securely in multiple angled positions. Clear connectors that blend into displays of any color.

- Two 3/4" height "J" style grippers joined by a flexible hinge
- Both sides hold .063" to .250" thick panels
- Custom lengths available
- Clear PVC material

ITEM #	OVERALL LENGTH	SIGN POSITION
108605	1"	Flush or Angled
108606	3"	Flush or Angled
108607	48"	Flush or Angled

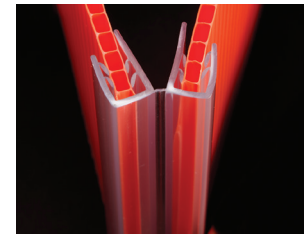
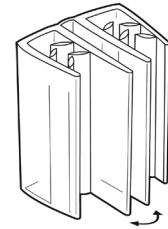

Gripper Dual Panel Holder

Dual capacity gripper fins attach and hold two sign panels back to back in flush position. Ideal for securely joining corrugated pallet drop bins or bulk merchandising displays together. Removable and reusable.

- 13/16" height
- Double "J" style
- Both sides fit 3/16" to 1/4" thick signs or panels
- Custom lengths available
- Clear PVC material

ITEM #	LENGTH
108723	1"

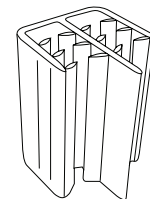

Gripper Display Sign Holder

Gripper fins attach and hold displays and signs securely in flush position. Part is removable and reusable.

- 1" height
- Double "J" style with two sides
- Oversized side fits .170" thick base acrylic or corrugated material
- Other side holds signs up to .080" thick in flush position
- Custom lengths available
- Clear PVC material

ITEM #	OVERALL LENGTH
108580	1-1/2"

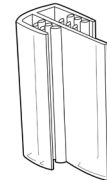

Display Construction

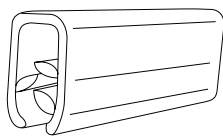

Budget "U" Channel Gripper Sign Holder

An inexpensive "U" style flush ticket and sign holder. Mount on sign edges to join two or more graphics together. Gripper fins hold sign and display materials straight and secure. Removable and reusable.

- Two grip ranges to choose from: standard and heavy duty
- Standard size has 3/8" height and heavy duty size has 9/16" height
- 1" long
- Custom lengths available
- Clear PVC material
- Custom colors available

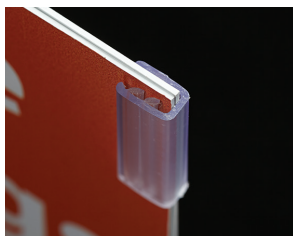

ITEM #	SIZE	BASE WIDTH	GRIP CAPACITY
110815	Standard	1/4"	.015" to .080"
110816	Heavy Duty	3/8"	.125" to .187"

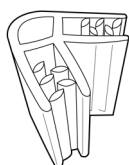

Gripper 60 Degree Two-Way Panel Former

Gripper fins hold and join two sign panel edges securely at a fixed 60 degree angle. Use several pieces to build and create unique displays or signs.

- 3/4" height
- Custom lengths available
- Clear PVC material
- Custom colors available



ITEM #	LENGTH	GRIP CAPACITY
108581	1"	up to .125"

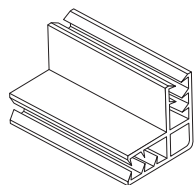

Gripper 90 Degree Two-Way Panel Former

Gripper fins hold and join two sign panel edges securely at a fixed 90 degree angle. Use several pieces to build and create unique displays or signs having right angles.

- 3/4" height right angles
- Custom lengths available
- Clear PVC material
- Custom colors available

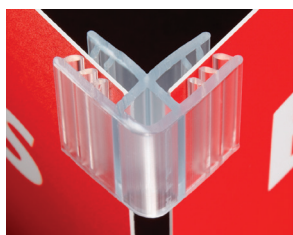

ITEM #	LENGTH	GRIP CAPACITY
108571	1"	up to .125"

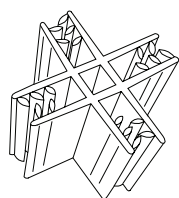

Gripper 90 Degree Four-Way Panel Former

Gripper fins hold and join up to four sign panel edges securely at fixed 90 degree angles. Use several pieces to build and create unique displays having right angles.

- 3/4" height right angles
- Custom lengths available
- Clear PVC material
- Custom colors available

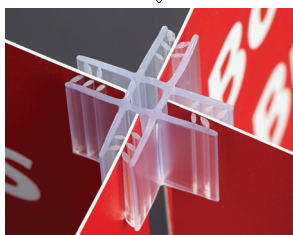

ITEM #	LENGTH	GRIP CAPACITY
108727	1"	up to .125"

Extruded Hinge With Adhesive

Join sign panels in either vertical or horizontal position. Integrated flexible center hinge allows for up to 180 degree panel angles in either direction. Adhesive sticks to any clean, flat surface.

- Two 5/8" height sections plus center hinge yields 1-1/4" overall height
- Top and bottom sections are both adhesive backed
- Custom lengths available
- Clear PVC material

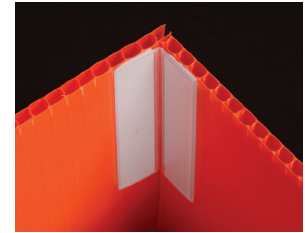
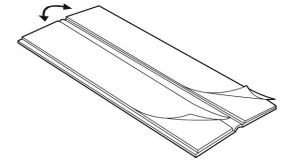

ITEM #	OVERALL LENGTH
108613	3"

“L” Bracket

Economical way to securely join sign panels in either vertical or horizontal positions and at fixed 90 degree angles. Available either with or without adhesive. Adhesive style sticks to any clean, flat surface. Non-adhesive style is great for use with glue or screws (not included), and can also be used as a corner piece/bracket.

- Both styles have 1" height right angles
- Adhesive is 3/4" wide, permanent, and on the outer side of both legs
- Custom lengths and colors available
- Also available in black, or with holes drilled – please inquire
- Clear PVC material

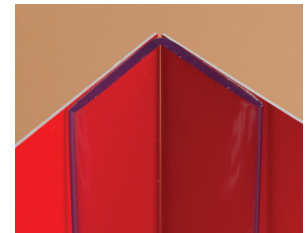
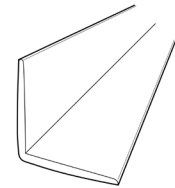

ITEM #	LENGTH	STYLE	COLOR
108688	3"	No Adhesive	Clear
108689	48"	No Adhesive	Clear
108704	3"	With White Foam Tape	Clear
108705	48"	With White Foam Tape	Clear

Display Construction

Gripper “H” Sign Holder

Gripper fins hold securely for mounting of signs above displays, other signs or to wire fixtures. Can be used in either vertical (flag) or horizontal position. Use two or more pieces for larger signs.

- 3/4" overall height
- Each side fits up to .080" diameter wire or holds signs up to .080" thick
- Custom lengths available
- Clear PVC material

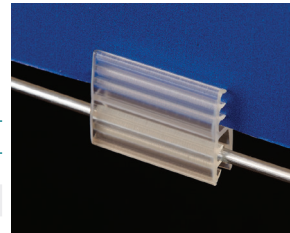
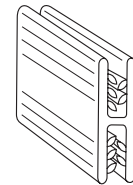

ITEM #	LENGTH
108518	1"
108519	3"

Gripper “H” Clip

Gripper fins hold securely for mounting of signs above displays, other signs/panels or to wire fixtures. Can be used in either vertical (flag) or horizontal position. Use two or more pieces for larger signs.

- 1" height
- One side fits up to .080" thick signs or up to .080" diameter wire
- Other side fits 1/8" to 3/16" thick signs or panels
- Custom lengths available
- Clear PVC material

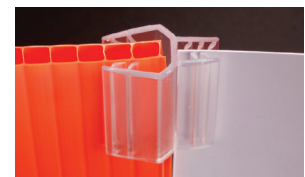
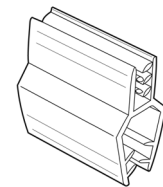

ITEM #	LENGTH
108609	1"
108610	1-1/2"

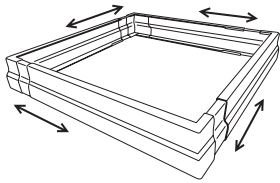

Adjustable Pallet Guard

Selling straight from the pallet made highly appealing, safe and secure. Enhance your store's appearance at an affordable price. Pallet guards hide unsightly floor placed pallets and protect merchandise from being damaged. Pallet guards also reduce the risk of customer trips and/or falls. Great for club stores or wholesale merchandise retail environments.

- Adjustable panels that fit a wide range of pallets from 28 inch to 54 inch in size
- Four pre-assembled panels that are 6 inch height each
- More durable than paper, corrugated or elastic band style pallet wraps
- Removable and reusable time and time again
- Easy to set up and extend with no tools required
- Also available in caution yellow, white and other custom colors – please inquire
- Durable black HIPS material



ITEM #	FITS PALLET SIZE	COLOR
107147B	28" to 54"	Black

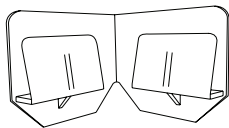

Flexible Display Foot

Two-point display foot that lifts, supports and protects display corners 1/2" above the floor. Flexible hinged design works on display corners at multiple angles, including 90 degrees. Simply friction fit attach to corrugated bottom edges.

- Holds up to 1/4" thick (A-Flute) corrugated 1/2" off the floor
- 1-9/16" overall height with a 5/16" diameter hole on each side
- Natural polypropylene material
- Packaged 100 per bag



ITEM #	CORNER DIMENSIONS
107137	1-7/8" x 1-7/8"

Display Construction

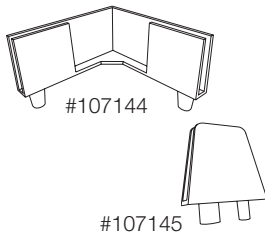

Rigid Display Feet

Three-point display foot that lifts, supports and protects display corners 1/2" above the floor. For added strength for larger floor based displays use the center style, two-point support between the corners. Simply friction fit each part to attach to corrugated bottom edges.

- Holds up to 3/16" (C-Flute) corrugated 1/2" off the floor
- Corner style is a fixed 90 degree angle and has corner dimensions of 2-1/2" x 2-1/2"
- Center style is 1-1/2" wide and has a tapered shape to a 1" wide top
- White styrene material



#107144



#107145

ITEM #	STYLE	OVERALL HEIGHT
107144	Corner	1-3/8"
107145	Center	1-3/4"

Floor Stand Corner Glide

Three point rigid display foot that lifts, supports, and protects display corners flush and low-profile to the floor at fixed, 90 degree angles. Adheres to flat bottom corrugated displays and floor stands with permanent adhesive. Durable display corner glide that makes moving fixtures or displays easy.

- Fixed 90 degree angle with both sides 2-1/2" from corner
- Holds displays approximately 1/16" off the floor
- Adhesive backed base
- Clear ABS material
- Packaged 200 per bag

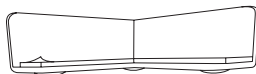

ITEM #	OVERALL HEIGHT	CORNER DIMENSIONS
107134	7/8"	2-1/2" x 2-1/2"

Display Caster With Adhesive

Adheres to flat bottom displays with permanent adhesive. Durable display foot that lifts, protects and makes moving heavy displays easy.

- #109544 round mini casters (also called “glide buttons”) have .200" height rounded contour foot
- #107139 square casters have .750" height rounded contour foot and supports up to 100 lbs. off the floor

ITEM #	BASE DIMENSIONS	MATERIAL
109544	1" Dia. Round	Natural Polyethylene
107139	2" x 2" Square	Natural Polypropylene

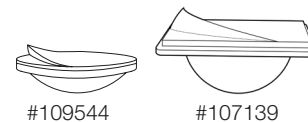

#109544



#107139

Plastic Master Display Caster

Highly popular caster. Fixed, smooth-running wheel set in a square, steel-reinforced black mounting bracket. Adheres to flat bottom displays with permanent adhesive and makes almost anything moveable in minutes. No tools needed – just peel and stick.

- Square, adhesive backed base
- 1-1/4" diameter non-swiveling wheel
- 1-1/2" overall height
- Supports a maximum capacity of 60 lbs. per caster
- Black high impact polystyrene (HIPS) material

ITEM #	BASE DIMENSIONS
107138	2" x 2"

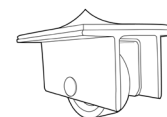

Swivel Display Caster With Corner Bracket

Swiveling, smooth-rolling independent wheel set threaded into a durable 90 degree corner support bracket (some assembly required). Lifts and protects display corners approximately 2 inches above the floor. Two styles to choose from: locking and non-locking. Simply friction fit each clear corner support bracket to attach to corrugated bottom edges. Makes almost any fixture or corrugated display easily moveable. Optional locking style can be used to both mobilize or immobilize a display.

- Holds up to 1/4" (A-Flute) corrugated 2" off the floor
- 1-9/16" wheel diameter with 5/16-18 x 3/4" long plated steel stem
- Reinforced corner bracket having dimensions of 3-1/2" x 3-1/2" x 1-1/4" height
- Supports a maximum of 75 lbs. per swivel caster (i.e. 300 lbs. total distributed weight among 4 swivel casters)
- Clear polycarbonate corner and black HIPS wheel
- Packed four complete assemblies per bag
- Sold only in full bags of four pieces

ITEM #	STYLE
107129	Swiveling and Non-Locking
107133	Swiveling and Locking

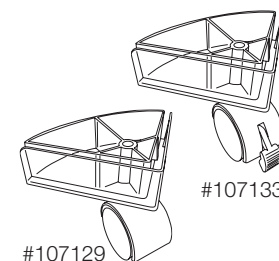

#107129

#107133



Twin Wheel Casters

Swiveling, smooth rolling independent wheel set offered with or without threaded stem. Lifts display corners approximately 2 inches above the floor. Two styles to choose from: locking and non-locking. For the non-threaded stem option, simply friction fit to create a seamless joint with no tools required. Makes almost any fixture or display easily moveable. Optional locking style can be used to both mobilize or immobilize a display.

- 1-9/16" wheel diameter
- Threaded style has a 5/16-18 x 3/4" long zinc plated steel stem
- Non-threaded style has a 7/16" diameter x 7/8" long zinc plated steel stem
- Supports a maximum of 75 lbs. per swivel caster (i.e. 300 lbs. total distributed weight among 4 swivel casters)
- Black HIPS wheel
- Sold only in full bags of four pieces

ITEM #	STEM TYPE	STYLE
107075	Threaded	Swiveling and Non-Locking
107076	Threaded	Swiveling and Locking
107077	Non-Threaded	Swiveling and Non-Locking
107078	Non-Threaded	Swiveling and Locking

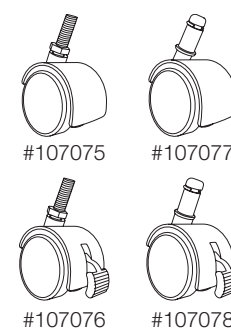

#107075

#107077

#107076

#107078



Locking

Non-Locking

Display Poles



Two section, rigid litho display poles/tubes with four common diameters to choose from. Male and female pieces (sold separately) are each 39 inches long; when fully assembled, total overall length is 6 feet. Great for when displays or signs require poles for support. The 6" long integrated inner core (joiner) on the male pole has tight tolerances for a secure fit. Male and female sections sold separately.

- When assembled, display pole is 6 ft. long
- Also available with holes or notches – please inquire
- Custom colors and/or lengths available
- White or black litho wrapped, spiral wound paper material

ITEM #	STYLE	SIZE	O.D.	I.D.	COLOR
107600	Male	Small	1"	13/16"	White
107603	Female	Small	1"	13/16"	White
107601	Male	Medium	1-1/2"	1-1/4"	White
107601B	Male	Medium	1-1/2"	1-1/4"	Black
107604	Female	Medium	1-1/2"	1-1/4"	White
107604B	Female	Medium	1-1/2"	1-1/4"	Black
107602	Male	Large	1-3/4"	1-15/32"	White
107602B	Male	Large	1-3/4"	1-15/32"	Black
107605	Female	Large	1-3/4"	1-15/32"	White
107605B	Female	Large	1-3/4"	1-15/32"	Black
NEW 107606	Male	Extra Large	2"	1-3/4"	White
NEW 107606B	Male	Extra Large	2"	1-3/4"	Black
NEW 107607	Female	Extra Large	2"	1-3/4"	White
NEW 107607B	Female	Extra Large	2"	1-3/4"	Black

Wire Display Pole Foot

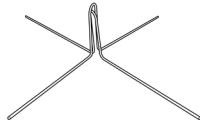

Simply press two identical/overlapping pieces into the inside of our common Display Poles (sold separately) to create an inexpensive, four-legged, sturdy base. Four sizes to choose from, each of which create a 24" overall tip-to-tip span.

- Sold by the piece, not the set
- Complete assembly requires two of the same size pieces
- Four sizes available for different inside diameter poles
- .177" wire diameter, bright galvanized steel

ITEM #	FITS POLE SIZE	OVERALL SPAN
108050	Small (13/16" I.D.)	24"
108051	Medium (1-1/4" I.D.)	24"
108052	Large (1-15/32" I.D.)	24"
NEW 108053	Extra Large (1-3/4" I.D.)	24"

Molded Plastic Display Feet Kit

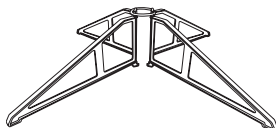

Our popular sturdy plastic display pole feet, a locking rubber ring and easy to follow instruction sheet packaged together in a convenient kit. Simply press each identical foot into the inside of common Display Poles of 1-1/2" to 2" O.D. (sold separately – see above) to create an inexpensive, yet elegant, four-legged base. More compact to ship than compared to traditional wire display pole feet. **Patented.**

- Each plastic foot measures 12" long x 5-1/4" height x 1/2" wide
- Creates a well balanced 26" overall tip-to-tip span
- Flexible rubber retaining ring is 1-3/4" I.D. x 7/32" thick
- One size fits three common fiber pole O.D.'s of 1-1/2", 1-3/4" and 2"
- Each sealed, clear polybagged kit contains four display pole feet, one ring and an instruction sheet
- Black plastic material

ITEM #	CONTENTS	COLOR
108055B	Four Molded Feet and One Ring	Black

Gripper Sign Holder For Display Poles

Add header signage to common display pole tops with this simple two-piece assembled holder. Unique "T" style adapter that fits two common size litho poles – specifically the O.D. of our small pole and the I.D. of our medium pole. Gripper fins hold signs securely in horizontal position. Dual slide-in/slide-over friction fit design that is both removable and reusable. Litho display poles sold separately (see page 198).

- Each part comes assembled and ready for use
- 2" overall non-inserted height
- Gripper top is 3" wide x 1" height and holds signs .080" to .250" thick
- "T" style base is white styrene material and gripper top is clear PVC
- Also available in black or custom colors – please inquire

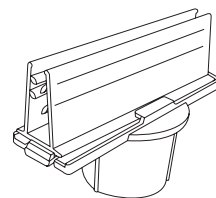

ITEM #	FITS POLE SIZES	OVERALL WIDTH
108060	Small (1" O.D.) & Medium (1-1/4" I.D.)	3"

Top Sign Holder For Display Poles

Add header signage to common display pole tops with this simple one-piece holder. Unique "T" style adapter that fits two common size litho poles – specifically, the O.D. of our small pole and the I.D. of our large pole. Internal interlocking ribs hold signs securely in horizontal position. Dual slide-in/slide-over friction fit design that is both removable and reusable. Litho display poles sold separately (see page 198).

- 1-3/4" overall non-inserted height
- Top is 3" wide x 13/16" height and holds signs .018" to .062" thick
- Also available in black, white or in custom colors – please inquire
- Clear styrene material

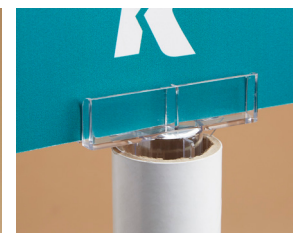
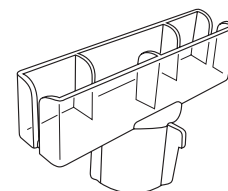

ITEM #	FITS POLE SIZES	OVERALL WIDTH
109519	Small (1" O.D.) & Large (1-15/32" I.D.)	3"

Modular Display Pole Shelf Support

Makes corrugated shelving assembly easy and saves on shipping costs. Prior to shipping four-sided corrugated shelving displays, Modular Display Pole Shelf Supports are combined with our small male Shelf Support Clips (included) to allow for pre-attachment of "knock down" shelving sections. As an added option, caps are available for a finished look on the top tier (sold separately – see below). Otherwise known as corrugated corner support shelving brackets.

- Included small male Shelf Support Clips fit up to 3/16" (C-Flute) corrugated
- Quick and easy friction fit assembly with our 1-3/4" O.D. Display Poles (sold separately)
- Round display pole supports are 2" outside diameter
- Small male shelf support clips are 1-7/8" height x 2-1/4" length
- White polypropylene material
- Packaged ten display pole supports and twenty small male shelf support clips per bag

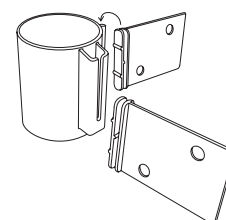

Cap sold separately

ITEM #	HEIGHT	FITS POLE SIZE
109514	2-1/2"	Large (1-3/4" O.D.)

Modular Display Pole Shelf Support Cap

When inserted into the top tier section of our Modular Display Pole Shelf Supports (sold separately), these caps provide the finishing touch needed for an upscale appearance.

- Secure low-profile flush style cap design
- 2" O.D. round flat head
- 3/4" long integrated cross style male insert for friction fit
- White polypropylene material
- Packaged 50 per bag



ITEM #	SIZE	FOR USE WITH
109515	2" O.D.	Modular Display Pole Shelf Support

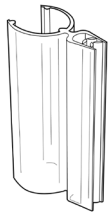

Pole Gripper Sign Holder

Gripper fins hold sign securely in vertical (flag) position. Clip-on design, coupled with gripper ribs, firmly attaches to display poles to prevent sign from rotating, thus allowing for a variety of viewing angles. Part is removable and reusable.

- Small and medium are 1/2" height and large is 5/8" height
- Three sizes to choose from
- Custom lengths available
- Clear PVC material

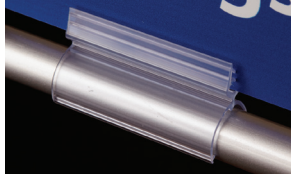

	ITEM #	LENGTH	FITS POLE SIZE	GRIP CAPACITY
	108591	3"	Small (1" O.D.)	up to .187"
NEW	140909	3"	Medium (1-1/2" O.D.)	up to .187"
	108770	3"	Large (1-3/4" O.D.)	.187" to .250"

Display Construction

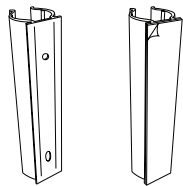

#108724 #108725

Premium Pole Gripper – Flush

Clip-on design coupled with gripper ribs prevent rotation. Firmly attach signs and promotions flush to common banner stands and display poles (sold separately). Also use integrated fastener holes (one round and one oval) or permanent adhesive backing to secure round poles to most surfaces. "Premium" size is stronger than our common Pole Gripper or Strap Clips. **Note:** When part is placed on the maximum 1" O.D. size, the flat mounting base area tends to bow a little.

- Fits 3/4" through 1" O.D. round poles
- .125" diameter hole option accepts common plastic or metal fasteners (sold separately)
- 3/4" wide x 4" long mounting base area
- Custom lengths available
- Clear PVC material



	ITEM #	OVERALL LENGTH	STYLE
	108724	4"	With Two Holes
	108725	4"	With Adhesive

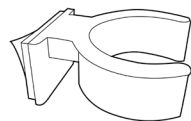

Pole Gripper

An easy way to secure display poles to most flat, clean surfaces with integrated permanent adhesive backing. Clip-on design is both fast and inexpensive. Also use to attach signs and promotions to Display Poles (sold separately). Available in two common sizes.

- Sturdy adhesive backed clip
- Small size has a 3/4" wide x 9/16" height backing
- Medium size has a 3-1/16" wide x 1" height backing
- White styrene material



	ITEM #	SIZE	FITS POLE SIZE
	107152	Small	Small (1" O.D.)
	107153	Medium	Medium (1-1/2" O.D.)

Adhesive Strap Clip

Fast, inexpensive way to attach display poles to most flat, clean surfaces with adhesive. Cable Tie passes through the channel area around the pole and then adjusts to desired size for a secure fit.

- Adhesive backed base is 1" long x 1-3/8" height
- Centered channel area has 1/4" inside width x 3/8" overall height
- Accepts Cable Ties .178" wide or less (sold separately)
- Clear PVC material

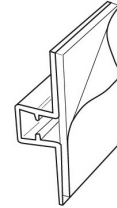

ITEM #	BASE LENGTH	BASE HEIGHT
107151	1"	1-3/8"

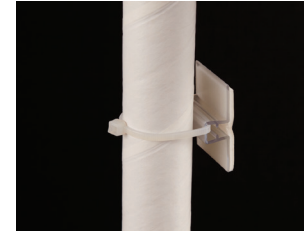
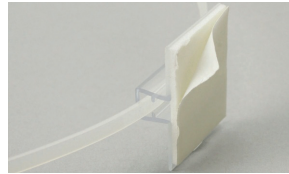

Cable Ties are sold separately – see page 202.
This clip can be used with parts #130500 through #130507 (.178" wide or smaller).

Pole Sign Cable Tie Kits

Fast, inexpensive way to secure both indoor and outdoor signs back to back on most round or square poles. Hang corplas or corrugated signs with confidence. Our most popular cable ties pre-packaged in a convenient kit. For back to back signs, the 36" long ties easily secure the signs to the pole, while the 8" long ties cinch the corners together. No tools required to assemble.

- 36" long ties are our popular #130512 (.340" wide)
- 8" long ties are our standard #130504 (.140" wide)
- Nylon 6/6 material
- Each sealed, clear polybagged kit contains two 36" long ties and four 8" long ties

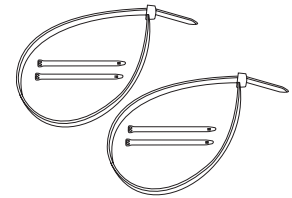

ITEM #	COLOR	CONTENTS
130525	Natural	Two 36" and Four 8" Ties
130525B	Black	Two 36" and Four 8" Ties



Display Construction

Indoor/Outdoor Sign-Mounting Bracket Kit

Secure, heavy-duty way to hang signs on most round or square poles, posts or columns with confidence. Stainless steel construction lends itself well to both indoor and outdoor use. All required components conveniently sealed in a clear poly bag. For two signs back to back, or for a dramatic three-sign triangular effect, combine additional brackets, bolts and washers (sold separately – please inquire). Some minor assembly required. **Warning:** Straps must be firmly fastened and locked down securely.

- Straps are 9/16" wide x 52" overall length with a slotted worm-drive hex screw housing
- 5/16-18 threaded brackets have slotted flared legs and measure 2-1/4" width x 1-1/2" height and will offset from pole approximately 5/8"
- Hex bolts are 5/16-18 x 5/8" long with 1/2" hex width across flats
- Flat washers are 5/16" bolt size x 5/8" O.D. – natural nylon
- Hex wrench and slotted screwdriver required (sold separately – see page 223).
- Stainless steel straps, brackets and bolts
- Each sealed, clear polybagged kit contains two straps, two brackets, two bolts and two washers



ITEM #	CONTENTS	FOR POLE SIZE
104020	Two Straps, Two Brackets, Two Bolts and Two Washers	3" thru 16" dia.



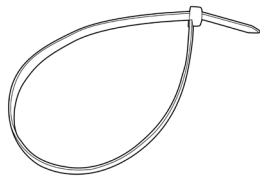

Cable Ties (Locking Straps)

Fast, inexpensive way to secure signs and other items. Simply adjust to desired size and lock permanently in place with ratcheting mechanism. A variety of lengths and widths allow for quick bundling of items. Black color is UV stabilized.

- Solid style
- Nylon 6/6 material
- Packaged as shown below

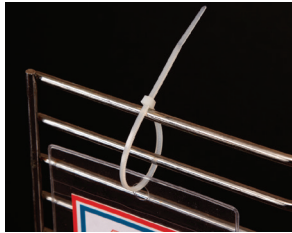

ITEM #	WIDTH	LENGTH	TENSILE STRENGTH	COLOR	PACKAGED
130500	.094"	4"	18#	Natural	1,000 per bag
130500B	.094"	4"	18#	Black	1,000 per bag
130501	.094"	6"	18#	Natural	1,000 per bag
130501B	.094"	6"	18#	Black	1,000 per bag
130502	.094"	8"	18#	Natural	1,000 per bag
130502B	.094"	8"	18#	Black	1,000 per bag
130503	.140"	5"	40#	Natural	1,000 per bag
130503B	.140"	5"	40#	Black	1,000 per bag
130504	.140"	8"	40#	Natural	1,000 per bag
130504B	.140"	8"	40#	Black	1,000 per bag
130505	.178"	7"	50#	Natural	1,000 per bag
130505B	.178"	7"	50#	Black	1,000 per bag
130506	.178"	11"	50#	Natural	1,000 per bag
130506B	.178"	11"	50#	Black	1,000 per bag
130507	.178"	14"	50#	Natural	1,000 per bag
130507B	.178"	14"	50#	Black	1,000 per bag
130514	.178"	17"	50#	Natural	100 per bag
130514B	.178"	17"	50#	Black	100 per bag
130508	.300"	8"	120#	Natural	100 per bag
130508B	.300"	8"	120#	Black	100 per bag
130509	.300"	15"	120#	Natural	100 per bag
130509B	.300"	15"	120#	Black	100 per bag
130510	.340"	24"	175#	Natural	50 per bag
130510B	.340"	24"	175#	Black	50 per bag
130512	.340"	36"	175#	Natural	50 per bag
130512B	.340"	36"	175#	Black	50 per bag
130513	.340"	48"	175#	Natural	50 per bag
130513B	.340"	48"	175#	Black	50 per bag

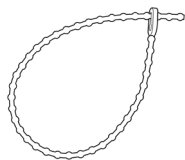

Releasable Beaded Locking Straps

Also known as Beaded Cable Ties. Fast, inexpensive way to temporarily or permanently secure signs and other items. Unlike our standard, solid style Cable Ties (Locking Straps), these releasable locking straps are removable and reusable. Just adjust to desired size anywhere along the full length and lock into place. Simple hand assembly with no tools required. Round ball design eliminates snags, cuts and abrasions.

- Tail beads/balls snap securely into head
- 4" long straps have a .200" head width x .350" head length
- 6", 8" and 10" long straps have a .230" head width x .490" head length
- Nylon 6/6 material



ITEM #	BEAD DIAMETER	LENGTH	COLOR
130560	.090"	4"	Natural
130561	.110"	6"	Natural
130562	.110"	8"	Natural
130563	.110"	10"	Natural

Fixed Style Security Tie

Fast, economical way to secure vinyl pouches, tags and/or tickets to just about anything. The thinnest naturally looping tie that we offer. Almost invisible, yet very strong. Fixed locked length. Tamperproof: must be cut to be removed.

- Available in three common lengths
- Non-adjustable fixed length design
- Cannot be re-used after engagement
- Natural nylon material
- Packaged 500 per bag

ITEM #	LENGTH	TENSILE STRENGTH
130553	3"	10#
130555	5"	10#
130559	9"	10#

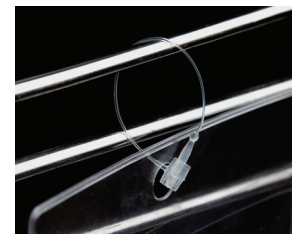
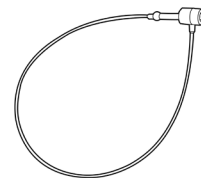

Ladder Style Permanent Locking Straps

Fast, inexpensive way to permanently secure signs and other items. Simply adjust to desired size anywhere along the full length and lock into place with built-in ratcheting mechanism. Unlike our standard, solid style Cable Ties (Locking Straps), ladder ties are extremely flexible and can be cut with scissors for easy removal.

- Straps are notched full length for a hollow laddered style
- Nylon 6/6 material
- Also available in black
- Packaged 1,000 per bag

ITEM #	WIDTH	LENGTH	TENSILE STRENGTH	COLOR
130570	.140"	7"	40#	Natural
130571	.140"	11"	40#	Natural

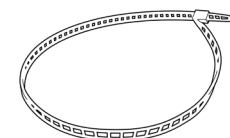

Loop Style Locking Strap

Hang lightweight signs, merchandising strips, vinyl pouches and more with this simple, inexpensive plastic fastener. The male and female ends bend around and snap together to create an approximate 7/8" loop length. Loop style straps are intended to be more permanent in nature and are not recommended to be pulled apart for reuse.

- Total overall length is 2-3/8"
- Both round heads are 3/8" diameter
- Strap is 1/8" wide x 1-5/8" long
- Pin dia. is 1/8"
- Maximum sign thickness is 20 mil
- Clear plastic material
- Packed 100 per bag

ITEM #	OVERALL LENGTH	COLOR
130565	2-3/8"	Clear



Power Panel Bar

When legs are inserted into the sides of perforated shelving, power bars allow for attachment of corrugated displays using plastic or metal wing clips (sold separately). Removable and reusable. Also known as a Wing Bar or Sidekick.

- .177" diameter wire, with two lengths to choose from
- Two attached arms that adjust to fit perforated shelf holes (round, square or diamond shaped) either 14" or 17-1/2" apart
- Bright galvanized steel material

ITEM #	OVERALL LENGTH
107108	15-1/2"
107119	19-1/4"

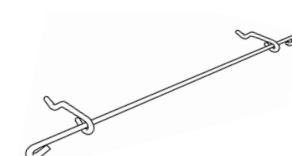



Power Wire Wing Clip

Our most popular size. Securely attach corrugated displays on wire power wing/bar (i.e. sidekick).

- Fits up to .250" diameter wire and 1/8" (B-Flute) corrugated
- Additional widths and colors can be made to order
- White high impact polystyrene (HIPS) material

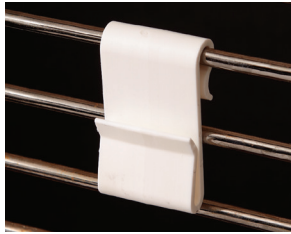

ITEM #	WIDTH	LENGTH
107101	1"	1-3/4"

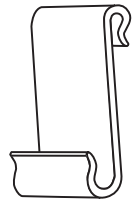

Power Wire Wing Clip – Long Style

Designed to securely attach corrugated displays on wire power wing/bar (i.e. sidekick).

- Fits up to .250" diameter wire and 1/8" (B-Flute) corrugated
- Additional widths and colors can be made to order
- White PVC material



ITEM #	WIDTH	LENGTH
107100	1"	2"

Display Construction



Heavy Duty Power Wire Wing Clip

Designed to securely attach corrugated displays on wire power wing/bar (i.e. sidekick). Larger clip width adds extra strength.

- Fits up to .250" diameter wire and 1/8" (B-Flute) corrugated
- Additional widths and colors can be made to order
- White polypropylene material
- Packaged 100 per bag



ITEM #	WIDTH	LENGTH
107102	1-1/4"	2-1/4"



Clear Power Wire Wing Clip

Designed to securely attach corrugated displays on wire power wing/bar (i.e. sidekick). Both clips are popular for heavy applications with #107104 offering extra duty strength.

- Fits up to .250" diameter wire and 1/8" (B-Flute) to 1/4" (A-Flute) corrugated
- Additional widths and colors can be made to order
- Clear rigid PVC material

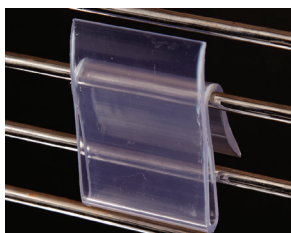

ITEM #	WIDTH	LENGTH
107103	1"	2"
107104	1-1/2"	2"

Metal Power Wire Wing Clip

Our strongest power panel clip – recommended for heavy displays. Designed to securely attach corrugated displays on wire power wing/bar (i.e. sidekick).

- Fits up to .219" diameter wire and 1/4" (A-Flute) corrugated
- Zinc plated steel material
- Packaged 50 per bag

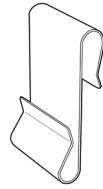

ITEM #	WIDTH	LENGTH
107107	1"	1-3/4"

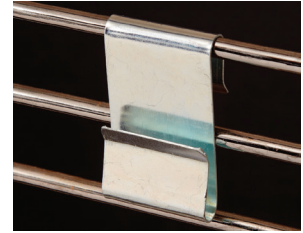

Metal Power Wire Wing Clip – Large Style

Our strongest and largest capacity metal heavy duty power panel clip. Recommended for heavier displays. Designed to securely attach corrugated displays on wire power wing/bar (i.e. sidekick).

- Fits up to .375" diameter wire and 5/16" corrugated
- Zinc plated steel material
- Packaged 50 per bag



ITEM #	WIDTH	LENGTH
107114	1"	1-3/4"

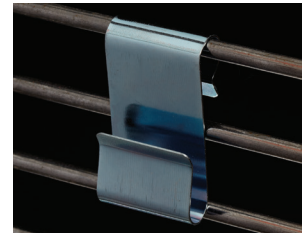

Warehouse Power Wing Clip – Plastic

Designed to securely attach corrugated displays in flush position to most teardrop shaped holes found on standard retail warehouse uprights.

- Attaching legs are 1-1/4" on center
- Fits most standard warehouse uprights
- Holds up to 1/8" (B-Flute) corrugated
- White PVC material

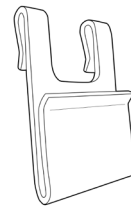

ITEM #	WIDTH	LENGTH
107116	1-1/2"	2-3/8"



Warehouse Power Wing Clip – Metal

Designed to securely attach corrugated displays in flush position to most teardrop shaped holes found on standard retail warehouse uprights. Metal clips are stronger than plastic and can be used for heavy displays.

- Attaching legs are 1-1/4" on center
- Fits most standard warehouse uprights
- Holds up to 1/8" (B-Flute) corrugated
- Zinc plated steel material
- Packaged 50 per bag



ITEM #	WIDTH	LENGTH
107115	1-1/2"	2-3/8"



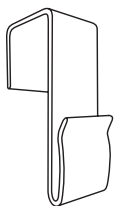

Square Edge Power Wing Clip

Designed to securely attach corrugated displays in flush position to square edged fixtures. Great for wood panels or endcaps.

- Fits up to 1" thick fixtures and 1/8" (B-Flute) to 1/4" (A-Flute) corrugated
- Additional colors can be made to order
- White ABS material



ITEM #	WIDTH	LENGTH
109521	1"	2-13/16"

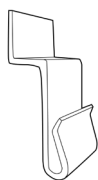

Slatwall Power Wing Clip

Designed to securely attach corrugated displays in flush position to slatwall. Z-bar shape is stronger than our plastic two prong Pegboard/Slatwall Power Wing Clip.

- Upper lip fits most standard slatwall grooves
- 1-1/2" high exposed base once inserted into slatwall
- Holds up to 1/8" (B-Flute) corrugated
- White PVC material



ITEM #	WIDTH	LENGTH
107113	1"	2"

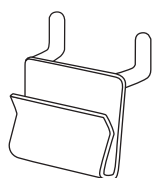

Pegboard/Slatwall Power Wing Clip

Designed to securely attach corrugated displays in flush position to pegboard and slatwall.

- Prongs are 1" on center
- Fits both standard 1/4" diameter pegboard and slatwall
- Holds up to 1/4" (A-Flute) corrugated
- White polypropylene material
- Packaged 100 per bag



ITEM #	WIDTH	LENGTH
107105	1-1/4"	1-1/4"

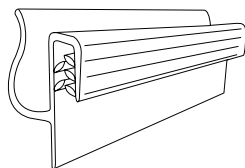

Gripper Flush Sign Holder For Slatwall

Gripper fins hold signs firmly in horizontal (flush) position. Use two or more holders for larger signs. The base is designed to fit into most standard slatwall. Removable and reusable.

- Fits most standard slatwall grooves
- 3" long x 1" tall
- Custom lengths available
- Gripper fins hold signs up to .080" thick
- Clear PVC material



ITEM #	LENGTH	GRIP CAPACITY	SIGN POSITION
108730	3"	up to .080"	Flush

Display Construction

Pegboard/Slatwall Adapter

Flush mount connectors that simply hook into pegboard holes or slatwall. Use to attach signs, pockets or literature holders.

- Both fit standard 1/4" diameter pegboard holes or slatwall
- Four prong offers heavy duty holding power
- Mounting base area: two prong has 5/8" height & four prong has 1" height
- Packaged as shown below

ITEM #	LENGTH	# OF PRONGS	PEGBOARD HOLE SPACING	STYLE	COLOR	MATERIAL	PACKAGED
108510	2-3/8"	2	2" on center	With Adhesive	White	High Impact Plastic	100 per bag
108510C	2-3/8"	2	2" on center	With Adhesive	Clear	High Impact Plastic	100 per bag
108509C	2-3/8"	2	2" on center	No Adhesive	Clear	High Impact Plastic	100 per bag
108511	3-1/2"	4	1" on center	With Adhesive	Natural	Polypropylene	50 per bag

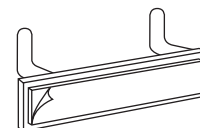

#108510

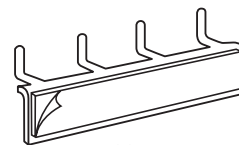

#108511



Z-Bar Slatwall Adapter

Use to attach signs, pockets or literature holders flush against slatwall. Z-bar shape is wider and stronger than our standard 1" and 2" slatwall adapters.

- 3/4" high adhesive base once inserted into slatwall
- Fits all standard slatwall grooves
- Available in custom lengths and additional colors
- Clear PVC material

ITEM #	OVERALL LENGTH	HEIGHT OF ADHESIVE
108512	2-3/8"	1/2"

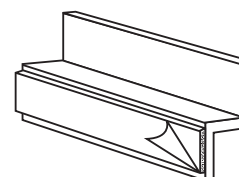

Slatwall Adapter With Adhesive

Use to attach signs, pockets, literature holders and lightweight displays flush against slatwall. Hold displays with attached permanent adhesive strip.

- Fits all standard slatwall grooves
- Additional lengths can be made to order
- .063" thick white styrene material

ITEM #	LENGTH	HEIGHT OF ADHESIVE
108500	1"	1/2"
108504	4"	1/2"

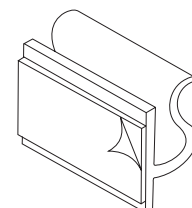

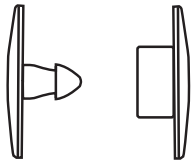

Snap Rivet Fastener

Combination of two mating parts (male & female) that permanently lock to connect flat panels together.

- Complete assembly requires two pieces – sold separately
- Both male and female have .625" O.D. round heads
- Female fits into .320" diameter hole size

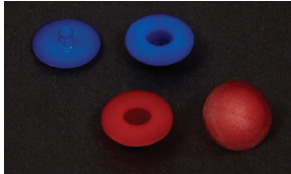

We can dye your Snap Rivets for you.

ITEM #	TYPE	GRIP CAPACITY	COLOR	MATERIAL
120320	Female	(fits all male lengths)	Natural	Nylon 6/6
120320B	Female	(fits all male lengths)	Black	Nylon 6/6
120320C	Female	(fits all male lengths)	Clear	Polycarbonate
120325	Male	.170" to .190"	Natural	Nylon 6/6
120325B	Male	.170" to .190"	Black	Nylon 6/6
120325C	Male	.170" to .190"	Clear	Polycarbonate
120327	Male	.220" to .240"	Natural	Nylon 6/6
120327B	Male	.220" to .240"	Black	Nylon 6/6
120327C	Male	.220" to .240"	Clear	Polycarbonate
120329	Male	.320" to .340"	Natural	Nylon 6/6
120329B	Male	.320" to .340"	Black	Nylon 6/6
120329C	Male	.320" to .340"	Clear	Polycarbonate

Reminder: One complete assembly requires two pieces – one male and one female – sold separately.

Display Construction

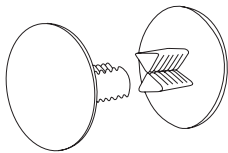

Ratchet Rivet Fastener

Simply press two pieces together. Serrated teeth adjust to a variety of locking depths and join panels together in a secure and permanent manner.

- Complete assembly requires two pieces
- Two round head diameters available (large & small)
- Fits into .281" diameter hole size

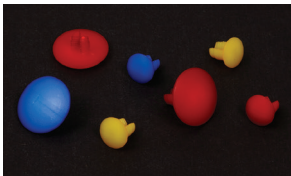
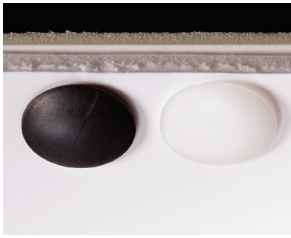

We can dye your Ratchet Rivets for you.



We can paint the heads for an exact color match.

ITEM #	HEAD O.D.	HEAD STYLE	GRIP CAPACITY	COLOR	MATERIAL
120300	.750"	Large	.235" to .297"	Natural	Nylon 6/6
120300B	.750"	Large	.235" to .297"	Black	Nylon 6/6
120300C	.750"	Large	.235" to .297"	Clear	Polycarbonate
120302	.750"	Large	.346" to .500"	Natural	Nylon 6/6
120302B	.750"	Large	.346" to .500"	Black	Nylon 6/6
120302C	.750"	Large	.346" to .500"	Clear	Polycarbonate
120303	.750"	Large	.500" to .812"	Natural	Nylon 6/6
120303B	.750"	Large	.500" to .812"	Black	Nylon 6/6
120303C	.750"	Large	.500" to .812"	Clear	Polycarbonate
120304	.750"	Large	.780" to 1.380"	Natural	Nylon 6/6
120304B	.750"	Large	.780" to 1.380"	Black	Nylon 6/6
120304C	.750"	Large	.780" to 1.380"	Clear	Polycarbonate
120305	.406"	Small	.235" to .297"	Natural	Nylon 6/6
120305B	.406"	Small	.235" to .297"	Black	Nylon 6/6
120305C	.406"	Small	.235" to .297"	Clear	Polycarbonate
120307	.406"	Small	.346" to .500"	Natural	Nylon 6/6
120307B	.406"	Small	.346" to .500"	Black	Nylon 6/6
120307C	.406"	Small	.346" to .500"	Clear	Polycarbonate
120308	.406"	Small	.500" to .812"	Natural	Nylon 6/6
120308B	.406"	Small	.500" to .812"	Black	Nylon 6/6
120308C	.406"	Small	.500" to .812"	Clear	Polycarbonate
120309	.406"	Small	.780" to 1.380"	Natural	Nylon 6/6
120309B	.406"	Small	.780" to 1.380"	Black	Nylon 6/6
120309C	.406"	Small	.780" to 1.380"	Clear	Polycarbonate

Reminder: One complete assembly requires two pieces.

Viking Clip Fastener – Push On Type

Two piece construction (screw & wing nut combination). Versatile wing nut fastener can be pushed on for fast assembly. This clip is extremely popular for sign & display construction. Removable & reusable.

- Fits .187" hole size
- Round screw head is 17/32" O.D.
- Round wing nut is 5/8" O.D.
- Screw or push on wing nut fastener to attach, and screw off to remove
- Polycarbonate material

ITEM #	GRIP CAPACITY	SCREW LENGTH	COLOR
120401	3/4"	7/8"	Clear
120402B	3/4"	7/8"	Black
120435	7/8"	1"	Clear
120406	1-3/8"	1-1/2"	Clear
120406B	1-3/8"	1-1/2"	Black

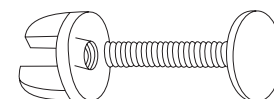

Quick-Grip Washer Fastener

Two piece construction (screw & retaining washer combination). Features fast attaching "slide-on" retaining nut for quick assembly of signs and displays. Provides a secure, non-removable hold.

- Fits .187" hole size
- Round screw head and retaining washer fastener are 9/16" O.D.
- Polycarbonate material

ITEM #	GRIP CAPACITY	SCREW LENGTH	COLOR
120403	1/2"	5/8"	Clear
120404	3/4"	7/8"	Clear

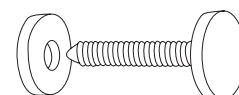

Thumbsnap Fastener

Unique arrow style tip deflects when pushed into a hole then springs back for a secure hold that resists removal.

- .500" O.D. flat head
- Fits .250" hole size
- Polypropylene material

ITEM #	SHANK LENGTH	MAXIMUM GRIP CAPACITY	COLOR
120397	.438"	1/8"	Natural
120397B	.438"	1/8"	Black
120398	.563"	1/4"	Natural
120398B	.563"	1/4"	Black

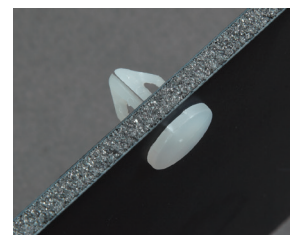
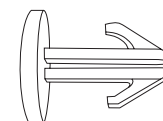

Pegboard Paper/Vinyl Fastener

Hollow body design allows the clip to compress when pushed into common 1/4" diameter pegboard holes and resist removal. Easy to install and remove with thumb and fingers – no tools required. Ingenious clip that greatly increases speed and efficiency when attaching backer paper or large vinyl formats to pegboard. Removable and reusable.

- Fits common 1/4" diameter pegboard holes
- .480" head O.D. with .250" ball top O.D.
- Natural polypropylene material

ITEM #	HOLE SIZE	OVERALL LENGTH	GRIP CAPACITY
120433	.250"	.985"	.125" to .187"



Perf Shelf Plastic Loop Fastener

Hang lightweight signs, displays or pouches with this simple, inexpensive plastic fastener. Designed to fit most round, square or diamond shaped perforated shelf holes. The male and female ends bend around to create an approximate 1/2" loop length. Simply press pin in to expand legs firmly into place.

- Total overall length is 1-7/8"
- Fits approximate .219" to .250" hole perforations
- Up to .187" grip capacity
- Strap is 1/8" wide x 1-1/16" long
- Natural polypropylene material
- Black also available – please inquire
- Packed 100 per bag

ITEM #	ENGAGED HEAD HEIGHT	PIN HEAD DIAMETER	COLOR
109520	.156"	.470"	Natural

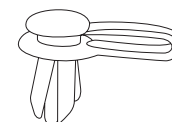

Display Construction

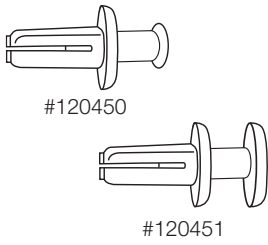

Perf Shelf Universal Fasteners

Both styles fit most round, square or diamond shaped perforated shelf holes, and can easily be removed and reused. Simply press pin in to expand legs that lock firmly in place. The low profile style offers a less noticeable, smaller pin head diameter and built-in side slots for easy removal.

- Pre-assembled two piece design
- Fits .250" hole size
- .001" to .187" grip capacity
- .500" shank length
- .438" O.D. flat heads
- Nylon 6/6 material



ITEM #	STYLE	ENGAGED HEAD HEIGHT	PIN HEAD DIAMETER	COLOR
120450	Low Profile	.093"	.240"	Natural
120450B	Low Profile	.093"	.240"	Black
120451	Standard	.140"	.430"	Natural
120451B	Standard	.140"	.430"	Black

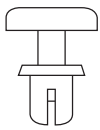

Perf Shelf White Snap Rivet

When combined with most round perforated shelf holes, this rivet yields .060" of grip capacity. Not recommended for square or diamond shaped perforated shelf holes. Simply press down on head to expand legs that lock panels and components firmly in place. No tools required.

- Pre-assembled two piece design
- .490" O.D. round head
- Nylon 6/6 material



ITEM #	HOLE SIZE	GRIP CAPACITY	SHANK LENGTH	COLOR
120452	1/4"	.098" to .157"	.240"	Natural
120452B	1/4"	.098" to .157"	.240"	Black

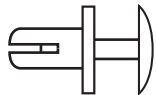

Expand-A-Lock Connector

Push-fit rivet style expansion fastener that requires no tools and fits most 5/32" to 11/64" round holes. Simply press pin down to expand legs that lock panels and components firmly in place.

- Pre-assembled two piece design
- 9/32" O.D. round head
- Nylon 6/6 material



ITEM #	HOLE SIZE	GRIP CAPACITY	SHANK LENGTH	COLOR
120405	5/32"	.100" to .250"	.315"	Natural
120405B	5/32"	.100" to .250"	.315"	Black

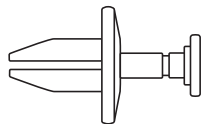

Heavy Duty Expand-A-Lock

Simply press pin down to expand two tapered legs that lock panels and components firmly in place. Fits standard 1/4" pegboard holes and 1/4" round shaped perforated shelf holes (not square or diamond). Removable and reusable.

- Pre-assembled two piece design
- 11/16" O.D. round head
- Nylon 6/6 material



ITEM #	HOLE SIZE	GRIP CAPACITY	SHANK LENGTH	COLOR
120399W	1/4"	.060" to .228"	.562"	White
120399B	1/4"	.060" to .228"	.562"	Black

Display Construction

Perf Shelf Channel Fastener

Unique triangular fin design that fits most round, square or diamond shaped perforated shelf holes. Is removable and can be reused.

- .625" O.D. flat head
- #120407 is very popular for shelving applications
- Nylon 6/6 material

ITEM #	HOLE SIZE	GRIP CAPACITY	SHANK LENGTH	COLOR
120407	.250"	.078" to .375"	.500"	White
120407B	.250"	.078" to .375"	.500"	Black
120422	.250"	.078" to .671"	.875"	White
120422B	.250"	.078" to .671"	.875"	Black



Perf Shelf Dart Clip

Fits most round, square or diamond shaped perforated shelf holes. Provides a secure hold. Is removable with a pinch and can be reused. Available in two common colors.

- .375" O.D. round head
- Polypropylene material

ITEM #	HOLE SIZE	GRIP CAPACITY	OVERALL LENGTH	COLOR
120400	.250"	.001" to .094"	.500"	White
120400C	.250"	.001" to .094"	.500"	Clear

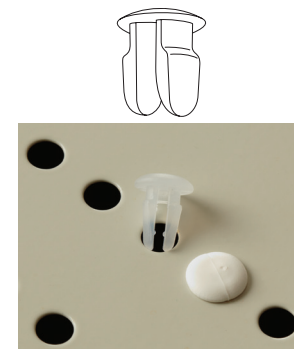

Diamond Hole Shelf Dart Clip

Fits diamond shaped or square perforated shelf holes. Also fits 7/32" diameter round holes. Provides a secure hold. Is removable with a pinch and can be reused.

- .344" O.D. round head
- Nylon 6/6 material

ITEM #	HOLE SIZE	GRIP CAPACITY	SHANK LENGTH	COLOR
120430	.219"	.001" to .093"	.420"	Natural
120430B	.219"	.001" to .093"	.420"	Black



Diamond Hole Shelf Push-In Clip

Features a larger head than our common shelf dart clips. Fits diamond shaped or square perforated shelf holes. Also fits 7/32" diameter round holes. Provides a secure hold. Is removable with a pinch and can be reused.

- .469" O.D. round head
- Nylon 6/6 material

ITEM #	HOLE SIZE	GRIP CAPACITY	SHANK LENGTH	COLOR
120858	.219"	.001" to .121"	.274"	Natural
120858B	.219"	.001" to .121"	.274"	Black

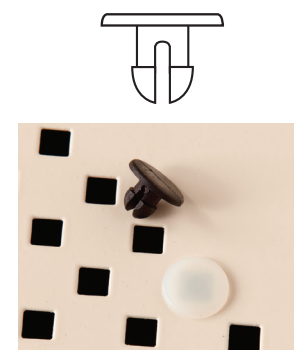

Dart Clip – Small

Hollow body design allows the clip to compress when pushed into hole, then expand back for a secure hold that resists removal. Removable and reusable.

- .406" O.D. round head
- For use in drilled, punched or molded holes
- Ideal where fast and/or blind installation is required
- Nylon 6/6 material

ITEM #	HOLE SIZE	GRIP CAPACITY	SHANK LENGTH	COLOR
120431	.187"	.125" to .187"	.563"	Natural
120431B	.187"	.125" to .187"	.563"	Black



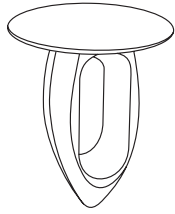

Dart (Arrow) Clip Fastener

Hollow body design allows the clip to compress when pushed into hole, then expand back for a secure hold that resists removal. Low cost way to assemble thin gauge materials. Simply snap in. No tools required. Removable and reusable.

- A variety of hole sizes, lengths & head diameters available
- Round heads
- For use in drilled, punched or molded holes
- Ideal where fast and/or blind installation is required
- #120418 is very popular for display construction & 1/4" hole dia. pegboard use

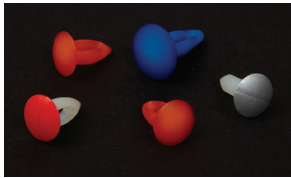

We can dye your clips for you, or paint the heads for an exact color match.

ITEM #	HOLE SIZE	SHANK LENGTH	GRIP CAPACITY	HEAD O.D.	HEAD HEIGHT	COLOR	MATERIAL
120410	.131" to .135"	.390"	.062" to .125"	.280"	.060"	Natural	Nylon 6/6
120410B	.131" to .135"	.390"	.062" to .125"	.280"	.060"	Black	Nylon 6/6
120411	.145" to .150"	.530"	.290" to .300"	.270"	.070"	Natural	Nylon 6/6
120411B	.145" to .150"	.530"	.290" to .300"	.270"	.070"	Black	Nylon 6/6
120412	.151" to .161"	.400"	.062" to .145"	.280"	.060"	Natural	Nylon 6/6
120412B	.151" to .161"	.400"	.062" to .145"	.280"	.060"	Black	Nylon 6/6
120413	.182" to .192"	.400"	.062" to .125"	.360"	.060"	Natural	Nylon 6/6
120413B	.182" to .192"	.400"	.062" to .125"	.360"	.060"	Black	Nylon 6/6
120414	.182" to .192"	.518"	.165" to .187"	.370"	.060"	Natural	Nylon 6/6
120414B	.182" to .192"	.518"	.165" to .187"	.370"	.060"	Black	Nylon 6/6
120415	.182" to .192"	.550"	.310" to .330"	.370"	.060"	Natural	Nylon 6/6
120415B	.182" to .192"	.550"	.310" to .330"	.370"	.060"	Black	Nylon 6/6
120416	.213" to .223"	.450"	.062" to .125"	.370"	.060"	Natural	Nylon 6/6
120416B	.213" to .223"	.450"	.062" to .125"	.370"	.060"	Black	Nylon 6/6
120417	.213" to .223"	.540"	.125" to .187"	.370"	.060"	Natural	Nylon 6/6
120417B	.213" to .223"	.540"	.125" to .187"	.370"	.060"	Black	Nylon 6/6
120418	.250" to .260"	.575"	.125" to .187"	.484"	.060"	Natural	Nylon 6/6
120418B	.250" to .260"	.575"	.125" to .187"	.484"	.060"	Black	Nylon 6/6
120418C	.250" to .260"	.575"	.125" to .187"	.484"	.060"	Clear	Polycarbonate
120419	.250" to .260"	.600"	.165" to .250"	.562"	.080"	Natural	Acetal
120419B	.250" to .260"	.600"	.165" to .250"	.562"	.080"	Black	Acetal
120420	.250" to .260"	.810"	.360" to .380"	.610"	.065"	Natural	Nylon 6/6
120420B	.250" to .260"	.810"	.360" to .380"	.610"	.065"	Black	Nylon 6/6
120421	.250" to .260"	1.135"	.500" to .750"	.610"	.068"	Natural	Nylon 6/6
120421B	.250" to .260"	1.135"	.500" to .750"	.610"	.068"	Black	Nylon 6/6

Display Construction

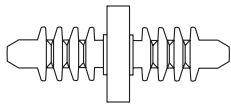

Double End X-Mas Tree Fastener

Used as a cross member when pressed into top and/or bottom edges of signs that slide into extruded frames. Also use to attach two sign panels back to back.

- Center flange with popular X-Mas Tree style fins (Standard fin type "X") on each side
- Nylon 6/6 material

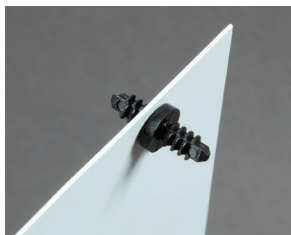

ITEM #	HOLE SIZE	OVERALL LENGTH	GRIP CAPACITY	SHANK LENGTH	COLOR
120204B	.156"	.677"	(End 1) .105" to .250" (End 2) .105" to .250"	(End 1) .305" (End 2) .305"	Black
120219	.312"	1.350"	(End 1) .125" to .375" (End 2) .140" to .750"	(End 1) .455" (End 2) .855"	Natural
120219B	.312"	1.350"	(End 1) .125" to .375" (End 2) .140" to .750"	(End 1) .455" (End 2) .855"	Black

X-Mas Tree Clip Fasteners

Flexible ribs deflect when pushed into hole then spring back for a secure lock that resists removal. Universal use in a wide variety of materials such as metal, wood, foam, rubber and plastic, in both solid and compressed forms. For use in a wide range of panel thicknesses and hole diameters.

- Wide variety of sizes & styles available
- For use in drilled, punched or molded holes, both threaded and non-threaded
- Ideal where fast and/or blind installation is required
- #120200, #120205 & #120212 are very popular for shelving and display construction
- Parts are separated on the following pages by the type of fins they have



X-Mas Tree Clip Fastener – Fin Type “P” – Reusable

- Solid shaft and self-centering design assures insertion and removal without damage to the retaining fins
- Removable and reusable – special shaft and fins retain their holding power and can be used again & again

ITEM #	HOLE SIZE	GRIP CAPACITY	SHANK LENGTH	FIN TYPE	HEAD O.D.	HEAD STYLE	COLOR	MATERIAL
120245	.118"	.069" to .197"	.386"	P	.216"	Flat	Natural	Nylon 6/6
120245B	.118"	.069" to .197"	.386"	P	.216"	Flat	Black	Nylon 6/6
120244	.197"	.067" to .315"	.496"	P	.433"	Flat	Natural	Nylon 6/6
120244B	.197"	.067" to .315"	.496"	P	.433"	Flat	Black	Nylon 6/6
120257	.197"	.060" to .430"	.700"	P	.433"	Flat	Natural	Nylon 6/6
120257B	.197"	.060" to .430"	.700"	P	.433"	Flat	Black	Nylon 6/6
120236	.236"	.079" to .236"	.472"	P	.472"	Round	Natural	Nylon 6/6
120236B	.236"	.079" to .236"	.472"	P	.472"	Round	Black	Nylon 6/6
120238	.236"	.079" to .531"	.774"	P	.472"	Round	Natural	Nylon 6/6
120238B	.236"	.079" to .531"	.774"	P	.472"	Round	Black	Nylon 6/6
120258	.250"	.030" to .291"	.433"	P	.728"	Round	Natural	Nylon 6/6
120258B	.250"	.030" to .291"	.433"	P	.728"	Round	Black	Nylon 6/6
120262	.250"	.028" to .510"	.749"	P	.728"	Round	Natural	Nylon 6/6
120262B	.250"	.028" to .510"	.749"	P	.728"	Round	Black	Nylon 6/6
120254	.250"	.173" to .571"	.791"	P	.625"	Round	Natural	Nylon 6/6
120254B	.250"	.173" to .571"	.791"	P	.625"	Round	Black	Nylon 6/6
120237	.281"	.080" to .532"	.787"	P	1.000"	Grain. Round	Natural	Nylon 6/6
120237B	.281"	.080" to .532"	.787"	P	1.000"	Grain. Round	Black	Nylon 6/6
120240	.281"	.138" to .710"	1.077"	P	.748"	Round	Natural	Nylon 6/6
120240B	.281"	.138" to .710"	1.077"	P	.748"	Round	Black	Nylon 6/6
120255	.281"	.063" to 1.000"	1.311"	P	.748"	Round	Natural	Nylon 6/6
120255B	.281"	.063" to 1.000"	1.311"	P	.748"	Round	Black	Nylon 6/6
120235	.281"	.080" to 1.260"	1.457"	P	1.000"	Grain. Round	Natural	Nylon 6/6
120235B	.281"	.080" to 1.260"	1.457"	P	1.000"	Grain. Round	Black	Nylon 6/6
120246	.312"	.025" to .512"	.895"	P	.752"	Crowned	Natural	Nylon 6/6
120246B	.312"	.025" to .512"	.895"	P	.752"	Crowned	Black	Nylon 6/6
120263	.312"	.040" to .472"	.945"	P	1.000"	Round	Natural	Nylon 6/6
120263B	.312"	.040" to .472"	.945"	P	1.000"	Round	Black	Nylon 6/6

Head styles are illustrated on our website: kinter.com

Complete list of all X-Mas Tree Clip Fasteners together can be found on our website: kinter.com

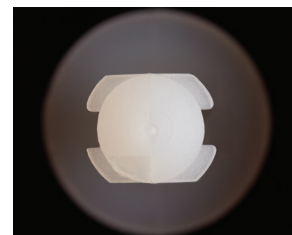
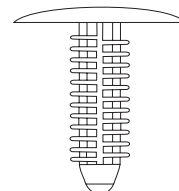

Display Construction

Additional styles of X-Mas Tree Clip Fasteners listed on the next two pages.



X-Mas Tree Clip Fastener – Fin Type “R” – Ratchet

- **Warning:** Attempted removal of fin type “R” push-in fasteners will result in damaged or distorted fins
- Not recommended for re-use
- #120205 is very popular for round hole shelving and display construction

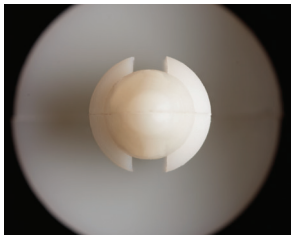
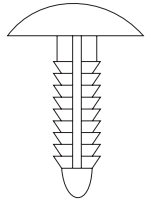

ITEM #	HOLE SIZE	GRIP CAPACITY	SHANK LENGTH	FIN TYPE	HEAD O.D.	HEAD STYLE	COLOR	MATERIAL
120232	.136"	.030" to .195"	.375"	R	.360"	Round	Natural	Nylon 6/6
120232B	.136"	.030" to .195"	.375"	R	.360"	Round	Black	Nylon 6/6
120228	.156"	.030" to .234"	.432"	R	.360"	Round	Natural	Nylon 6/6
120228B	.156"	.030" to .234"	.432"	R	.360"	Round	Black	Nylon 6/6
120276B	.187"	.030" to .312"	.480"	R	.437"	Flat	Black	Nylon 6/6
120220	.187"	.030" to .312"	.480"	R	.437"	Round	Natural	Nylon 6/6
120220B	.187"	.030" to .312"	.480"	R	.437"	Round	Black	Nylon 6/6
120234	.187"	.030" to .312"	.480"	R	.734"	Round	Natural	Nylon 6/6
120234B	.187"	.030" to .312"	.480"	R	.734"	Round	Black	Nylon 6/6
120271	.187"	.030" to .448"	.680"	R	.336"	Round	Natural	Nylon 6/6
120271B	.187"	.030" to .448"	.680"	R	.336"	Round	Black	Nylon 6/6
120214	.187"	.030" to .512"	.680"	R	.437"	Round	Natural	Nylon 6/6
120214B	.187"	.030" to .512"	.680"	R	.437"	Round	Black	Nylon 6/6
120243	.218"	.059" to .236"	.500"	R	.650"	Round	Natural	Nylon 6/6
120243B	.218"	.059" to .236"	.500"	R	.650"	Round	Black	Nylon 6/6
120233	.218"	.060" to .560"	.774"	R	.510"	Round	Natural	Nylon 6/6
120233B	.218"	.060" to .560"	.774"	R	.510"	Round	Black	Nylon 6/6
120230	.218"	.060" to .560"	.774"	R	.650"	Round	Natural	Nylon 6/6
120230B	.218"	.060" to .560"	.774"	R	.650"	Round	Black	Nylon 6/6
120275	.250"	.030" to .290"	.437"	R	.437"	Binder	Natural	Nylon 6/6
120275B	.250"	.030" to .290"	.437"	R	.437"	Binder	Black	Nylon 6/6
120226	.250"	.090" to .350"	.610"	R	.700"	Round	Natural	Nylon 6/6
120226B	.250"	.090" to .350"	.610"	R	.700"	Round	Black	Nylon 6/6
120229	.250"	.125" to .406"	.625"	R	.500"	Binder	Natural	Nylon 6/6
120229B	.250"	.125" to .406"	.625"	R	.500"	Binder	Black	Nylon 6/6
120252	.250"	.078" to .448"	.787"	R	.492"	Round	Natural	Nylon 6/6
120252B	.250"	.078" to .448"	.787"	R	.492"	Round	Black	Nylon 6/6
120273	.250"	.079" to .449"	.790"	R	.551"	Round	Natural	Nylon 6/6
120273B	.250"	.079" to .449"	.790"	R	.551"	Round	Black	Nylon 6/6
120205	.250"	.098" to .472"	.802"	R	.700"	Round	Natural	Nylon 6/6
120205B	.250"	.098" to .472"	.802"	R	.700"	Round	Black	Nylon 6/6
120205C	.250"	.098" to .472"	.802"	R	.700"	Round	Clear	Polypropylene
120205W	.250"	.098" to .472"	.802"	R	.700"	Round	White	Nylon 6/6
120213	.250"	.098" to .800"	1.060"	R	.700"	Round	Natural	Nylon 6/6
120213B	.250"	.098" to .800"	1.060"	R	.700"	Round	Black	Nylon 6/6
120269	.250"	.090" to .722"	1.103"	R	.866"	Flat	Natural	Nylon 6/6
120269B	.250"	.090" to .722"	1.103"	R	.866"	Flat	Black	Nylon 6/6
120282B	.250"	.415" to 1.130"	1.275"	R	.700"	Round	Black	Nylon 6/6
120247	.250"	.420" to 1.140"	1.383"	R	.700"	Round	Natural	Nylon 6/6
120247B	.250"	.420" to 1.140"	1.383"	R	.700"	Round	Black	Nylon 6/6
120247W	.250"	.420" to 1.140"	1.383"	R	.700"	Round	White	Nylon 6/6
120286	.250"	.180" to 1.570"	1.760"	R	.700"	Round	Natural	Nylon 6/6
120286B	.250"	.180" to 1.570"	1.760"	R	.700"	Round	Black	Nylon 6/6
120231	.281"	.059" to .555"	.834"	R	.748"	Round	Natural	Nylon 6/6
120231B	.281"	.059" to .555"	.834"	R	.748"	Round	Black	Nylon 6/6
120225	.281"	.060" to 1.000"	1.200"	R	.750"	Round	Natural	Nylon 6/6
120225B	.281"	.060" to 1.000"	1.200"	R	.750"	Round	Black	Nylon 6/6
120249	.281"	.311" to 1.180"	1.476"	R	1.000"	Grain. Round	Natural	Nylon 6/6
120249B	.281"	.311" to 1.180"	1.476"	R	1.000"	Grain. Round	Black	Nylon 6/6
120274	.322"	.027" to .196"	.480"	R	.511"	Flat	Natural	Nylon 6/6
120274B	.322"	.027" to .196"	.480"	R	.511"	Flat	Black	Nylon 6/6
120270	.322"	.110" to .437"	.736"	R	1.000"	Round	Natural	Nylon 6/6
120270B	.322"	.110" to .437"	.736"	R	1.000"	Round	Black	Nylon 6/6
120227B	.343"	.055" to .510"	.752"	R	.630"	Binder	Black	Nylon 6/6
120223	.394"	.060" to .787"	1.110"	R	.846"	Round	Natural	Nylon 6/6
120223B	.394"	.060" to .787"	1.110"	R	.846"	Round	Black	Nylon 6/6
120224	.406"	.115" to .565"	.820"	R	1.000"	Round	Natural	Nylon 6/6
120224B	.406"	.115" to .565"	.820"	R	1.000"	Round	Black	Nylon 6/6

Display Construction

X-Mas Tree Clip Fastener – Fin Type “X” – Standard

- **Warning:** Attempted removal of fin type “X” push-in fasteners will result in damaged or distorted fins
- Not recommended for re-use
- #120200 & #120212 are very popular for shelving and display construction

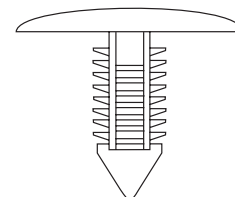

ITEM #	HOLE SIZE	GRIP CAPACITY	SHANK LENGTH	FIN TYPE	HEAD O.D.	HEAD STYLE	COLOR	MATERIAL
120221	.125"	.135" to .250"	.308"	X	.240"	Flat	Natural	Nylon 6/6
120221B	.125"	.135" to .250"	.308"	X	.240"	Flat	Black	Nylon 6/6
120207	.156"	.035" to .312"	.531"	X	.375"	Mod. Flat	Natural	Nylon 6/6
120207B	.156"	.035" to .312"	.531"	X	.375"	Mod. Flat	Black	Nylon 6/6
120208	.187"	.035" to .210"	.438"	X	.437"	Flat	Natural	Nylon 6/6
120208B	.187"	.035" to .210"	.438"	X	.437"	Flat	Black	Nylon 6/6
120211	.187"	.080" to .400"	.560"	X	.337"	Round	Natural	Nylon 6/6
120211B	.187"	.080" to .400"	.560"	X	.337"	Round	Black	Nylon 6/6
120210	.187"	.080" to .402"	.640"	X	.437"	Flat	Natural	Nylon 6/6
120210B	.187"	.080" to .402"	.640"	X	.437"	Flat	Black	Nylon 6/6
120218	.187"	.100" to .600"	.700"	X	.470"	Grain. Bind	Natural	Nylon 6/6
120218B	.187"	.100" to .600"	.700"	X	.470"	Grain. Bind	Black	Nylon 6/6
120291B	.187"	.100" to .600"	.750"	X	.594"	Grain. Bind	Black	Nylon 6/6
120264	.187"	.200" to 1.150"	1.375"	X	.437"	Flat	Natural	Nylon 6/6
120264B	.187"	.200" to 1.150"	1.375"	X	.437"	Flat	Black	Nylon 6/6
120206	.203"	.060" to .480"	.700"	X	.750"	Grain. Flat	Natural	Nylon 6/6
120206B	.203"	.060" to .480"	.700"	X	.750"	Grain. Flat	Black	Nylon 6/6
120212	.234"	.080" to .312"	.500"	X	.609"	Flat	Natural	Nylon 6/6
120212B	.234"	.080" to .312"	.500"	X	.609"	Flat	Black	Nylon 6/6
120212C	.234"	.080" to .312"	.500"	X	.609"	Flat	Clear	Polycarbonate
120209	.234"	.140" to .750"	.945"	X	.500"	Binder	Natural	Nylon 6/6
120209B	.234"	.140" to .750"	.945"	X	.500"	Binder	Black	Nylon 6/6
120265	.250"	.075" to .185"	.394"	X	.618"	Flat	Natural	Nylon 6/6
120265B	.250"	.075" to .185"	.394"	X	.618"	Flat	Black	Nylon 6/6
120200	.250"	.095" to .320"	.500"	X	.750"	Flat	Natural	Nylon 6/6
120200B	.250"	.095" to .320"	.500"	X	.750"	Flat	Black	Nylon 6/6
120200C	.250"	.095" to .320"	.500"	X	.750"	Flat	Clear	Polycarbonate
120289	.250"	.040" to .640"	.887"	X	.496"	Round	Natural	Nylon 6/6
120289B	.250"	.040" to .640"	.887"	X	.496"	Round	Black	Nylon 6/6
120242	.250"	.040" to .750"	1.065"	X	.750"	Square	Natural	Nylon 6/6
120242B	.250"	.040" to .750"	1.065"	X	.750"	Square	Black	Nylon 6/6
120201	.250"	.065" to 1.250"	1.440"	X	1.000"	Flat	Natural	Nylon 6/6
120201B	.250"	.065" to 1.250"	1.440"	X	1.000"	Flat	Black	Nylon 6/6
120216	.281"	.050" to .440"	.703"	X	.937"	Crowned	Natural	Nylon 6/6
120216B	.281"	.050" to .440"	.703"	X	.937"	Crowned	Black	Nylon 6/6
120268	.281"	.145" to .455"	.723"	X	.808"	Crowned	Natural	Nylon 6/6
120268B	.281"	.145" to .455"	.723"	X	.808"	Crowned	Black	Nylon 6/6
120203	.281"	.093" to .470"	.745"	X	.625"	Flat	Natural	Nylon 6/6
120203B	.281"	.093" to .470"	.745"	X	.625"	Flat	Black	Nylon 6/6
120277B	.281"	.062" to .750"	.894"	X	.787"	Round	Black	Nylon 6/6
120281B	.281"	.250" to .800"	.945"	X	.500"	Round	Black	Nylon 6/6
120217	.281"	.530" to .920"	1.190"	X	1.250"	Binder	Natural	Nylon 6/6
120217B	.281"	.530" to .920"	1.190"	X	1.250"	Binder	Black	Nylon 6/6
120202	.281"	.050" to .900"	1.260"	X	.760"	Crowned	Natural	Nylon 6/6
120202B	.281"	.050" to .900"	1.260"	X	.760"	Crowned	Black	Nylon 6/6
120215	.281"	.100" to .870"	1.310"	X	.600"	Crowned	Natural	Nylon 6/6
120215B	.281"	.100" to .870"	1.310"	X	.600"	Crowned	Black	Nylon 6/6
120266	.281"	.810" to 1.580"	2.020"	X	.600"	Crowned	Natural	Nylon 6/6
120266B	.281"	.810" to 1.580"	2.020"	X	.600"	Crowned	Black	Nylon 6/6
120222	.312"	.130" to .500"	.660"	X	.500"	Binder	Natural	Nylon 6/6
120222B	.312"	.130" to .500"	.660"	X	.500"	Binder	Black	Nylon 6/6

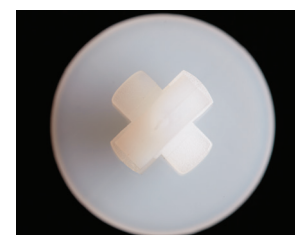

Display Construction

Head styles are illustrated on our website: kinter.com

Complete list of all X-Mas Tree Clip Fasteners together can be found on our website: kinter.com

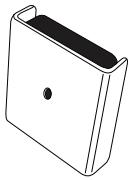

Magnetic Adapter

Rectangular metal casing containing an integrated ceramic magnetic base(s). Compact, versatile magnet assures full contact and maximum holding power. Use in a variety of applications; for instance, attaching lightweight signs and display products to metal surfaces such as shelving. Also ideal for latches and receptacles. Mount with adhesive (shown below) or a common 1/8" pop rivet. Removable and reusable. **Warning:** Holding capacity is the approximate maximum pull rating under ideal conditions. Always test suitability on a per-application basis. For best results, use on an indoor, bare (unfinished) metal surface that is smooth and clean. Metal conditions will affect holding power. Magnets should not be used near electronic equipment.

- 7/8" wide x 1/4" overall height, with 1/8" diameter center hole
- 3" long magnet has a hollow underside center area
- Available with optional non-scratch inserts (see below)
- Nickel plated steel housing

ITEM #	OVERALL LENGTH	HORIZONTAL CAPACITY
107033	1"	12 lbs.
107037	3"	16 lbs.

Magnetic Adapter With Adhesive

Our highly popular ceramic magnetic adapters with 3M brand high bond adhesive tape applied directly to the rectangular metal casing. Compact, versatile magnet assures full contact and maximum holding power. Great for numerous P.O.P. applications. Simply peel off the 3M factory liner and stick to any clean, smooth surface. Best suited for indoor use. **Warning:** Magnets should not be used near electronic equipment.

- Available with optional non-scratch inserts (see below)
- 7/8" wide x 1/4" overall height
- 3" long magnet has a hollow underside center area
- Tape is high tack acrylic based adhesive that reaches maximum strength within 24 hours
- Nickel plated steel housing with .025" thick tape

ITEM #	OVERALL LENGTH	TAPE COLOR
107080	1"	Gray
107083	3"	Gray

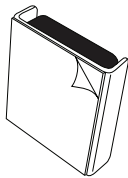

Non-Scratch Magnetic Insert

Ingenious flexible insert that helps reduce the possibility of magnet scratching and abrasion on finished or painted surfaces. Specifically designed to friction fit most undersides of our rectangular magnets or magnetic based gripper sign holders (sold separately). Single-sided raised edge allows for rapid assembly and assures that the adapter will remain in alignment with the magnet. Also makes separating stacked magnets a breeze. **Warning:** When inserted properly into a magnet, this spacer/insert will reduce the original stated holding capacity of the magnet. Always test holding power suitability on a per-application basis.

- Friction fit – no glue or adhesive required
- Factory installed inserts are available with most of our rectangular magnets – please inquire
- When used with 1" magnets, inserts will block the use of the center hole
- Not for use with our line of ladderless magnetic banner hangers or ceiling clips
- Not recommended for use on non-Kinter-supplied magnets
- .020" thick natural low density polyethylene material

ITEM #	LENGTH	WIDTH
107040	1"	13/16"

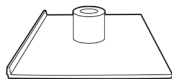

Heavy Duty Magnetic Adapter

Rectangular metal casing having a full three ceramic magnetic base making this part stronger than our common 3" long magnet #107037. Use this heavy duty magnet when more holding power is required. Perfect for larger upright signs or heavier displays. Two integrated mounting holes also offers additional strength benefits when attaching with screws or common 1/8" pop rivets – not included. Removable and reusable. **Warning:** Holding capacity is the approximate maximum pull rating under ideal conditions. Always test suitability on per-application basis. For best results, use on an indoor, bare (unfinished) metal surface that is smooth and clean. Metal conditions will affect holding power. Magnets should not be used near electronic equipment.

- Available with optional non-scratch inserts (see page 216)
- 1/4" overall height x 7/8" wide x 3" long
- Each end has a 1/8" diameter round hole
- Also available with adhesive – please inquire
- Nickel plated steel housing

ITEM #	OVERALL LENGTH	HORIZONTAL CAPACITY
107050	3"	22 lbs.



Extra Heavy Duty Magnetic Adapter

By far our strongest magnet for maximum holding power. Extra heavy duty rectangular metal casing containing an integrated ceramic magnetic block base. Use to display large format upright signs or heavy display products from metal surfaces such as gondola tops or pallet rack uprights. Mount with screws or common 3/16" pop rivets (not included). Removable and reusable. **Warning:** Holding capacity is the approximate maximum pull rating under ideal conditions. Always test suitability on per-application basis. For best results, use on an indoor, bare (unfinished) metal surface that is smooth and clean. Metal conditions will affect holding power. Magnets should not be used near electronic equipment.

- 1/2" overall height x 1-1/2" wide x 3" long
- Each end has a slotted shaped hole measuring .202" wide x .355" long
- Zinc plated steel housing

ITEM #	OVERALL LENGTH	HORIZONTAL CAPACITY
107049	3"	60 lbs.

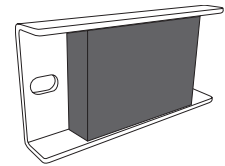

Display Construction

Rectangular Neo Magnet With Adhesive

Low profile, popular neodymium magnet with clear adhesive transfer tape applied to one side. Compact, versatile magnet that assures full contact and maximum holding power. Small consistent radius edges equate to a smooth, burr-free product. Great for numerous P.O.P. applications. Simply peel off the 3M factory liner and stick to any clean, smooth surface. Best suited for indoor use.

Warning: Magnets should not be used near electronic equipment.

- Otherwise known as "Rare Earth Magnets"
- Super powerful and compact
- 1/16" thickness x 1/2" wide x 1" long
- Meets neodymium industry standard #3512 properties with adhesive on south pole side

ITEM #	OVERALL LENGTH	THICKNESS	FINISH
107059	1"	1/16"	Nickel

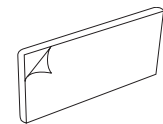

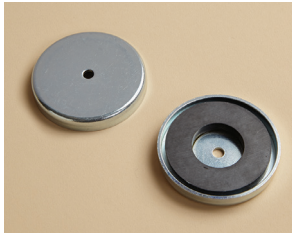
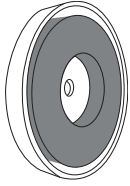

Round Magnetic Adapter

Round magnetic casing containing an integrated ceramic magnetic base. Compact, versatile magnet assures full contact and maximum holding power. Use in a variety of applications: for instance, attaching signs and display products to metal surfaces such as shelving. Mount with adhesive or a common 3/16" pop rivet. Two sizes to choose from with both being removable and reusable.

Warning: Holding capacity is the approximate maximum pull rating under ideal conditions. Always test suitability on a per-application basis. For best results, use on an indoor, bare (unfinished) metal surface that is smooth and clean. Metal conditions will affect holding power. Magnets should not be used near electronic equipment.

- Both sizes have a 3/16" diameter center hole
- Round magnet base with nickel plated round steel housing

ITEM #	BASE O.D.	OVERALL HEIGHT	HORIZONTAL CAPACITY
107055	1-13/32"	1/4"	15 lbs.
107047	2"	5/16"	35 lbs.

Round Neo Disk Magnet



Extremely strong magnets for their small, compact size. Neodymium disk magnets are solid and do not have a center hole so mounting requires glue, adhesive and/or counter boring. Small consistent radius edges equate to a smooth, burr-free product. Great for use as display door latches offering a secure closure and extra holding power. Best suited for indoor use. **Warning:** Magnets should not be used near electronic equipment. Due to their small size, please keep away from children/pets.

- Otherwise known as "Rare Earth Magnets"
- Meets neodymium industry standard #4212 and #4512 properties
- Super powerful and compact

ITEM #	OUTSIDE DIAMETER	THICKNESS	FINISH
107051	7/16"	3/16"	Nickel
107227	1"	1/16"	Nickel

Flexible Magnets

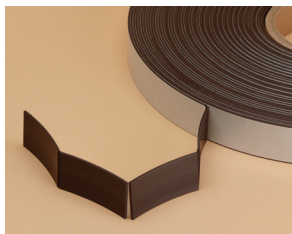
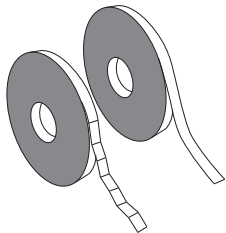

Convenient 100 ft. long rolls of our most popular flexible magnets. Offered two ways: in pre-cut (scored) pieces or on a continuous length roll that can easily be cut with scissors to any length. Great for mounting lightweight signs and display products to steel shelves or warehouse racks. Adheres to any clean, flat surface – simply peel and stick. Also known as Rubber Magnets or Magnetic Tape.

Warning: Magnets should not be used near electronic equipment.

- Custom lengths, widths and thicknesses also available – please inquire
- 1/16" thick flexible black magnet with clear acrylic adhesive backing for indoor or outdoor use
- Sold in full 100 ft. long rolls only

ITEM #	MAGNET SIZE	ROLL QUANTITY
107041	1/2" W x 1" L	1,200 pieces
107042	1" W x 2" L	600 pieces
107043	1" W x 100 Continuous Feet	100 feet

Hook & Loop Fasteners

Highly popular for numerous P.O.P. applications and signs with changing messages. Hook and loop fasteners provide holding power with flexibility and fast set up time for immediate use. Simply peel tape or coins from paper/clear liner and stick to any clean, smooth, dry surface. Best suited for indoor use.

- Hook and loop sold separately
- Coins are also known as Buttons, Tabs or Dots
- Tape and coins made from durable woven nylon material
- Both tape and coins have high tack, rubber based adhesive backing
- Temperature use range: 0°F to 170°F
- Additional sizes and custom cuts can be made to order
- Packaged in continuous 25 yard long rolls
- Special packaging available, including mated sets or kiss-cut pieces

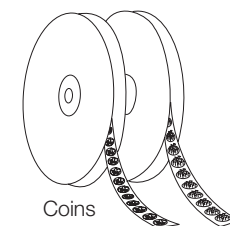
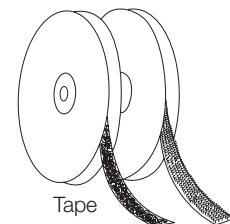

ITEM #	TYPE	DESCRIPTION	COLOR	ROLL QUANTITY	MATING PART (SOLD SEPARATELY)
150502	Tape	5/8" Hook	White	25 yards	150503
150503	Tape	5/8" Loop	White	25 yards	150502
150502B	Tape	5/8" Hook	Black	25 yards	150503B
150503B	Tape	5/8" Loop	Black	25 yards	150502B
150504	Tape	3/4" Hook	White	25 yards	150505
150505	Tape	3/4" Loop	White	25 yards	150504
150504B	Tape	3/4" Hook	Black	25 yards	150505B
150505B	Tape	3/4" Loop	Black	25 yards	150504B
150506	Tape	1" Hook	White	25 yards	150507
150507	Tape	1" Loop	White	25 yards	150506
150506B	Tape	1" Hook	Black	25 yards	150507B
150507B	Tape	1" Loop	Black	25 yards	150506B
150510	Tape	2" Hook	White	25 yards	150511
150511	Tape	2" Loop	White	25 yards	150510
150510B	Tape	2" Hook	Black	25 yards	150511B
150511B	Tape	2" Loop	Black	25 yards	150510B
150602	Coins	1/2" Hook	White	1,440 pieces	150603
150603	Coins	1/2" Loop	White	1,440 pieces	150602
150602B	Coins	1/2" Hook	Black	1,440 pieces	150603B
150603B	Coins	1/2" Loop	Black	1,440 pieces	150602B
150606	Coins	3/4" Hook	White	1,028 pieces	150607
150607	Coins	3/4" Loop	White	1,028 pieces	150606
150606B	Coins	3/4" Hook	Black	1,028 pieces	150607B
150607B	Coins	3/4" Loop	Black	1,028 pieces	150606B
150608	Coins	7/8" Hook	White	900 pieces	150609
150609	Coins	7/8" Loop	White	900 pieces	150608
150608B	Coins	7/8" Hook	Black	900 pieces	150609B
150609B	Coins	7/8" Loop	Black	900 pieces	150608B

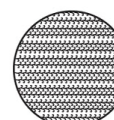

Hook
(rough)



Loop
(soft)

Display Construction

Kinter can cut and mate your Hook & Loop in-house. Ask a KinterCare representative to tell you more.

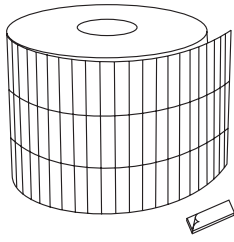

Double-Sided Pre-Cut Foam Tape

Our most popular and convenient to use pre-cut sizes of double-sided white foam tape. Parts are supplied kiss cut (scored) on a roll for quick and easy application - simply peel and stick. Options are two-sided permanent or two-sided removable adhesive. Permanent style is high tack and bonds to low surface energy plastics, powder-coated materials and some UV coatings. Removable style is perfect for temporary displays or sign use on non-delaminating surfaces. Great for use on metal, cardboard, paper, plastic and PVC foam board surfaces.

- Can be cut smaller with scissors
- Permanent or removable adhesive on two opposing sides
- Permanent liner printed ink color is blue
- Removable liner printed ink color is green
- Additional lengths, widths, thicknesses and black also available – please inquire
- White foam material
- #150680 and #150682 are sheet perforated every 18 pieces
- Sold in full rolls only



ITEM #	WIDTH	LENGTH	THICKNESS	STYLE	ROLL QUANTITY
150680	1/2"	1"	1/16"	Permanent	19,998 pieces
150682	1/2"	1"	1/16"	Removable	4,986 pieces
150681	3/4"	2-3/4"	1/16"	Permanent	5,000 pieces
150683	3/4"	2-3/4"	1/16"	Removable	5,000 pieces
150684	1"	1"	1/16"	Removable	5,000 pieces

Display Construction

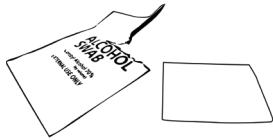

Alcohol Swab

Include in hardware kits wherever adhesives or films are encountered. A soft isopropyl alcohol swab self-contained within a convenient tear packet. Use to properly clean and prepare surfaces before applying adhesive backed items (such as sign supports, data strips, flexible magnets or hook & loop products) for maximum holding strength. Can also be used to help remove stubborn adhesive residue or films from warehouse racking or store fixtures. **Warning:** Make certain that the surface is completely dry before applying adhesive backed products. Vapors can be strong, and direct contact with eyes may cause irritation.

- Single-use general cleaner for most surfaces
- 70% isopropyl alcohol preps by volume
- .062" thick white rectangular swab containing isopropyl alcohol
- Packaged 100 individually wrapped swabs per box



ITEM #	SWAB DIMENSIONS	PACKET DIMENSIONS
105010	1-1/4" H x 1" W	2-1/4" H x 1-3/4" W

Foam Block Stand-Off

Foam block stand-offs add dimension to displays and signage. Used to create a 3-D effect that makes your graphics stand out. Place foam blocks 1"-2" from the edge of your graphic to create multi-layered displays for added depth. Can also be used to create gondola shelf wobblers or aisle violators.

- 1" H x 1" W x 1" L square blocks
- Permanent adhesive on two opposing sides – simply peel and stick
- Can be stuck together to create longer stand-offs
- White foam material
- 36 kiss-cut blocks per sheet
- Sold in full sheets only

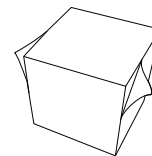

ITEM #	LENGTH	WIDTH	HEIGHT	COLOR
150675	1"	1"	1"	White

Bumper Buttons

Non-marring adhesive backed bumper buttons. Great for attaching to cabinets, doors or to the bottom of displays and literature holders. Abrasion and skid resistant. Shock and vibration dampening. Easy peel & stick application to any clean, flat surface. Offered in both clear and black.

- Tops are flat, cylindrical style
- Adhesive is clear rubber based for either indoor or outdoor use
- Other shapes, sizes and colors also available – please inquire
- Polyurethane material
- 200 pieces per sheet/pad
- Sold in full sheets only

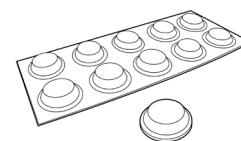

ITEM #	O.D.	HEIGHT	COLOR
150650	1/2"	.060"	Clear
150650B	1/2"	.060"	Black
150651	1/2"	.140"	Clear
150651B	1/2"	.140"	Black

Display Construction

Upright Flip Inserts

Securely attach signs, displays and fixtures onto common upright slots found in gondolas and warehouse pallet racking. Simply put the screw through the fixture, then into the threaded insert nut, then engage upright and tighten.

- Threaded nut inserts are .100" thick
- Screws have Slotted/Phillips combination drive undersized pan heads
- Both inserts and screws are zinc plated steel
- Parts come unassembled
- Packaged 100 nut inserts and 100 screws per bag

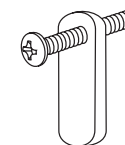

#140231

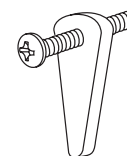

#140230

ITEM #	TYPE	NUT DIMENSIONS	SCREW DIMENSIONS	FITS
140231	Gondola	10-32, 1-3/16" L x .350" W	10-32 x 1" L with .312" Head O.D.	Gondola Slot: 3/4" L x 3/8" W
140230	Pallet Rack	1/4-20, 1-3/16" L x .500" W	1/4-20 x 1-1/4" L with .414" Head O.D.	Warehouse Teardrop Style Holes



#140231



#140230



Toggler® Anchor

All purpose, secure fitting, hollow wall fastener offering great versatility and extra holding power. Great for use in display construction, hollow walls, paneling and drywall. Simply fold down the 1-1/2" to 1-7/8" spread anchor wings, insert into hole and use key (sold separately) to expand the toggler wings. Can be used in combination with a #8 to #12 diameter self-tapping screw (also sold separately). If used with a screw, the screw may be removed and the anchor will remain in place for re-use.

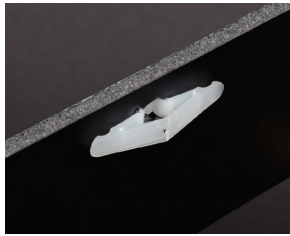
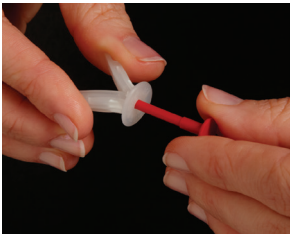

- 9/16" diameter round head
- For use in a 5/16" diameter hole, with material up to 1/2" thick
- Anchors and setting pin are sold separately
- Natural polypropylene material

ITEM #	SIZE	DESCRIPTION
140215	1/8" to 1/4" capacity	Anchor
140214	3/8" to 1/2" capacity	Anchor
140216	1-1/8" long	Red Setting Pin (Key)

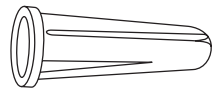

Wall Anchor – Light Duty Conical

Our most economical anchor. For use in drywall, concrete, wood or brick. Anchor has horizontal fins that expand as screw is driven in. Excellent for use with lightweight menu boards, literature holders and signs. To install, insert anchor in drilled hole, insert screw through fixture into anchor and tighten.

- Use in combination with a self tapping or wood screw (sold separately)
- Polypropylene material

ITEM #	FITS SCREW SIZE	LENGTH	HOLE DRILL SIZE	COLOR
140210	#8 to #10	7/8"	3/16"	Blue
140211	#10 to #12	1"	1/4"	Red

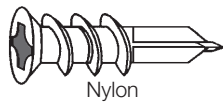

Nylon

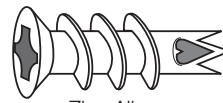

Zinc Alloy

Wall Anchor – Medium Duty Zip-It®

No pre-drilling of hole required. Self drilling point cuts right into 3/8" to 5/8" thick drywall. Simply screw anchor into drywall, then insert screw through fixture into anchor and tighten. Deep coarse threads create strong engagement and hold. Replaces plastic conical anchors where more strength is required.

- Flush, low profile Phillips countersinking head
- Use in combination with a self tapping screw or screw eye (sold separately)
- Minimum required screw length engagement for all sizes is 3/4"

ITEM #	FITS SCREW SIZE	LENGTH	MATERIAL
140200	#6 x 1"	1-5/16"	Nylon
140202	#6 x 1"	1-1/16"	Zinc Alloy
140201	#8 x 1"	1-11/16"	Nylon
140203	#8 x 1"	1-5/16"	Zinc Alloy

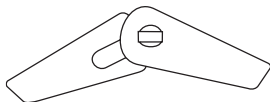

Wall Anchor – Heavy Duty Toggle Wing

Great for use in drywall, paneling, block and hollow base display construction where extra holding power is required. Spring wing type hollow wall anchor is made of two wings connected by a threaded nut and a coil spring. Wings open automatically behind the wall to prevent pull-through. To install, put the screw through the fixture, thread toggle wing onto screw, fold wings back and insert anchor through pre-drilled hole until wings spring open, then tighten screw.

- Use in combination with a machine screw or eye bolt (sold separately)
- Zinc plated steel material

ITEM #	FITS SCREW SIZE	LENGTH	HOLE DRILL SIZE *
140220	6-32 (1/8")	1-1/2"	3/8"
140222	10-24 (3/16")	2-1/8"	1/2"
140223	1/4-20 (1/4")	2-1/8"	5/8"

* In hard/solid materials, you may need to drill the hole 1/16" larger than what is listed above.



Screws sold separately



Don't forget: we also carry screws!

Wing Nut & Bolt Kit

One complete set of all hardware needed to hold heavier displays securely. Also great for attaching sign fixtures to common shelf tops or undersides through the round, square or diamond shaped perforated shelf holes. Use two or more kits for larger displays. Parts are removable and reusable.

- Bolt is a 10-32 x 3/4" long Phillips pan head machine screw – steel, zinc plated
- Wing nut is a stamped style 10-32 – steel, zinc plated
- Flat washer is .375" O.D. x .194" I.D. x .062" thick natural nylon
- Each sealed, clear polybagged kit contains one bolt, one wing nut and one washer
- Other hardware sizes or packaging quantities per bag available – please inquire

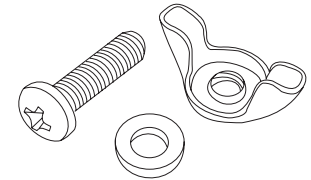

ITEM #	CONTENTS
105015	One Screw, One Wing Nut and One Washer

Economy Screwdrivers

Our most economical screwdrivers. Include these in hardware kits. Large, comfortable plastic handles offer a secure grip and solid turning power.

- #2 Phillips drive fits most screws 5-40 through 10-24 diameter
- #3 Phillips drive fits most screws 12-24 through 1/4-20 diameter
- 1/4" Slotted is the width of the tip of the blade
- Handles are 1" O.D. black polypropylene material
- Round blades are 15/64" dia. heat treated steel
- Items below have Phillips or Slotted drive blades – also available with Torx or Square drive blades

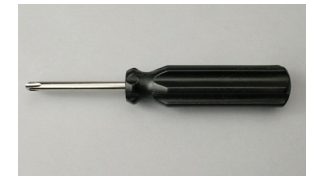
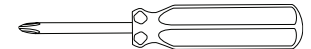

ITEM #	BLADE DRIVE	OVERALL LENGTH	HANDLE LENGTH	BLADE LENGTH
105075	#2 Phillips	3"	1-3/4"	1-1/4"
105085	1/4" Slotted	3"	1-3/4"	1-1/4"
105076	#2 Phillips	4"	1-3/4"	2-1/4"
105086	1/4" Slotted	4"	1-3/4"	2-1/4"
105077	#2 Phillips	6"	3-3/4"	2-1/4"
105087	1/4" Slotted	6"	3-3/4"	2-1/4"
105078	#3 Phillips	6"	3-3/4"	2-1/4"



Phillips

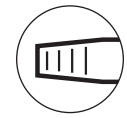

Slotted

Single End Economy Wrenches

Our most economical hex wrench. Designed for light duty, single-use (a.k.a. disposable style). Include these in hardware kits where light duty assembly is required.

- For use on common hex bolts and nuts
- 1" wide x 3" long
- 16 gauge cold rolled flat steel – zinc plated



ITEM #	SIZE *
105060	1/4" Hex Width Across Flats
105061	5/16" Hex Width Across Flats
105062	3/8" Hex Width Across Flats
105063	7/16" Hex Width Across Flats
105064	1/2" Hex Width Across Flats

* **Please note:** Wrench sizes are based upon hex width across flats of nuts and bolts – not diameter

Combination Economy Wrench

An economical, double ended multi-size range hex wrench. Designed for light duty, single-use (a.k.a. disposable style). Include these in hardware kits where light duty assembly is required.

- For use on common hex bolts and nuts, sizes 1/4" through 3/8" diameter
- 1-1/4" wide x 3-3/8" long
- 16 gauge cold rolled flat steel – zinc plated

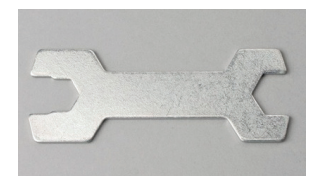
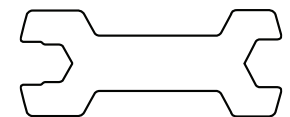

ITEM #	SIZE *
105065	7/16", 1/2" & 9/16" Hex Width Across Flats

* **Please note:** Wrench sizes are based upon hex width across flats of nuts and bolts – not diameter

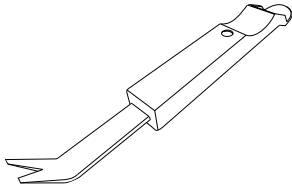

Fastener & Label Remover Tool

Multi-purpose tool that is ideal for removing even the most stubborn push-in fasteners from shelving and pegboard holes. Turn the tool around and use the scraper end to speed up insertion or removal of labels from info strips or shelf channels. Unlike our competitors' less expensive plastic removal tools, our tool is made of steel and thus is far less likely to break under even extreme prying conditions.

- Smooth handle shape that forms to the hand for comfortable use
- Durable plastic handle is 3/4" wide x 5/8" thick
- Flat metal angled blade is 1/2" wide x 3/32" thick
- Integrated .234" diameter hole centered within the handle
- Black polypropylene handle with nickel plated steel blade

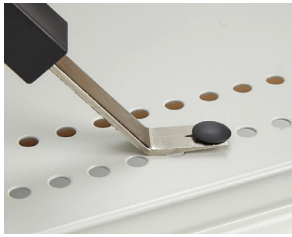

ITEM #	OVERALL LENGTH	HANDLE LENGTH	BLADE LENGTH
105090	7"	4-3/4"	2-1/4"

Easy-Off Fastener & Label Remover Tool – Plastic

Strong, multi-purpose tool designed for removing fasteners from shelves and pegboard holes. Turn the tool around and use the scraper end to speed up insertion or removal of labels from info strips or shelf channels. Less likely to break than economy style plastic tools yet a less expensive alternative to our steel version tool. Extra-long handle design provides additional leverage for stubborn push-in fasteners.

- Two useful tools in one
- Durable handle is 5/8" wide x 7/16" thick
- Shovel style end with integrated prying fork
- Handy .297" diameter hole centered within the handle
- Durable acetal plastic



ITEM #	OVERALL LENGTH	COLOR
105092	8-1/2"	Orange

Economy Fastener & Label Remover Tool

An inexpensive, economical style multi-purpose tool designed for removing fasteners from shelves and pegboard holes. Turn the tool around and use the scraper end to speed up insertion or removal of labels from info strips or shelf channels. Contoured ergonomic shaped universal tool.

- Smooth handle design that forms to the hand for comfortable use
- .828" x .640" thick with prying style fork end
- Integrated .297" diameter hole centered within the handle
- Polypropylene material
- Packaged 50 per box

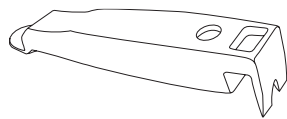

ITEM #	OVERALL LENGTH	COLOR
105091	5-1/4"	Black

Display Construction



Rings & Binder Posts



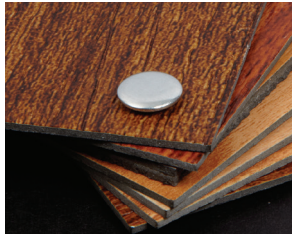
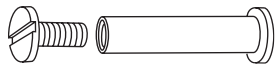

We can paint the heads of your posts & screws for an exact color match.



Anodized colors also available.

Aluminum Binder Post & Screws 8-32

Each binder post assembly consists of one post and one screw. Low profile, matching head on both the post and the screw allow for a nice clean look. Aluminum material is much stronger and more durable than nylon post and screw imitations. Binding capacity is determined by length of post used. Use one of three aluminum screws for standard, removable applications. Use #100043 for rapid assemblies in lightweight applications. Use #100049 for permanent applications.

- Post and screw sold separately
- Aluminum female posts are .200" dia. x .415" head O.D. – unslotted
- Aluminum male screws are 8-32 thread dia. x .415" head O.D. – slotted
- For use in 7/32" holes

ITEM #	DESCRIPTION	LENGTH	MATERIAL	HEAD TYPE	MATING SCREW (SOLD SEPARATELY)
100050	Removable Screw	3/16"	Aluminum	Slotted Drive	n/a
100051	Removable Screw	1/4"	Aluminum	Slotted Drive	n/a
100052	Removable Screw	3/8"	Aluminum	Slotted Drive	n/a
100043	Push-In Screw	3/8"	Gray Plastic	Slotted Hand Press-In	n/a
100049	PermaLock Screw	3/8"	Nickel Plated Steel	Unslotted Tap-In *	n/a
100048	Binder Post	1/8"	Aluminum	Open End, No Drive	100050
100053	Binder Post	3/16"	Aluminum	Open End, No Drive	100051
100054	Binder Post	1/4"	Aluminum	Open End, No Drive	100051
100045	Binder Post	1/4"	Aluminum	Closed End, No Drive **	100050
100055	Binder Post	3/8"	Aluminum	Open End, No Drive	100052
100047	Binder Post	3/8"	Aluminum	Closed End, No Drive **	100051
100056	Binder Post	1/2"	Aluminum	Closed End, No Drive	100052
100057	Binder Post	5/8"	Aluminum	Closed End, No Drive	100052
100058	Binder Post	3/4"	Aluminum	Closed End, No Drive	100052
100059	Binder Post	7/8"	Aluminum	Closed End, No Drive	100052
100060	Binder Post	1"	Aluminum	Closed End, No Drive	100052
100061	Binder Post	1-1/4"	Aluminum	Closed End, No Drive	100052
100062	Binder Post	1-1/2"	Aluminum	Closed End, No Drive	100052
100063	Binder Post	1-3/4"	Aluminum	Closed End, No Drive	100052
100064	Binder Post	2"	Aluminum	Closed End, No Drive	100052
100065	Binder Post	2-1/4"	Aluminum	Closed End, No Drive	100052
100066	Binder Post	2-1/2"	Aluminum	Closed End, No Drive	100052
100067	Binder Post	2-3/4"	Aluminum	Closed End, No Drive	100052
100068	Binder Post	3"	Aluminum	Closed End, No Drive	100052
100069	Binder Post	3-1/4"	Aluminum	Closed End, No Drive	100052
100070	Binder Post	3-1/2"	Aluminum	Closed End, No Drive	100052
100072	Binder Post	4"	Aluminum	Closed End, No Drive	100052
100073	Binder Post	4-1/2"	Aluminum	Closed End, No Drive	100052
100074	Binder Post	5"	Aluminum	Closed End, No Drive	100052
100076	Binder Post	6"	Aluminum	Closed End, No Drive	100052

* #100049 PermaLock Screw works with aluminum posts only – not brass

** Optional closed end short length posts

Aluminum Binder Post Extensions 8-32

When used in conjunction with Aluminum Binder Posts, extensions add length in order to increase binding capacity as needed.

- .200" post diameter
- 8-32 thread diameter on both male and female ends
- #100030 accepts #100050 removable binder screw; all other extensions accept #100052
- For use in 7/32" holes
- Aluminum material

ITEM #	EXTENSION LENGTH
100030	1/4"
100031	1/2"
100032	3/4"
100033	1"



Black Aluminum Binder Post & Screws 8-32

Durable black anodized finish on our most popular sizes of aluminum binder posts and matching screws. It should be noted that during the anodizing process a very small, randomly located contact point(s) will reveal a bare aluminum spot. Each black anodized post assembly consists of one post and one screw. Low profile, matching head on both the post and the screw allow for a nice clean look. Binding capacity is determined by length of post used.

- Post and screw sold separately
- Female posts are .203" dia. x .415" head O.D. – unslotted
- Male screws are 8-32 thread dia. x .415" head O.D. – slotted
- Additional lengths available in black upon request
- For use in 7/32" holes
- Aluminum material, anodized black



ITEM #	DESCRIPTION	LENGTH	HEAD TYPE	MATING SCREW (SOLD SEPARATELY)
100050B	Removable Screw	3/16"	Slotted Drive	n/a
100051B	Removable Screw	1/4"	Slotted Drive	n/a
100052B	Removable Screw	3/8"	Slotted Drive	n/a
100048B	Binder Post	1/8"	Open End, No Drive	100050B
100053B	Binder Post	3/16"	Open End, No Drive	100051B
100054B	Binder Post	1/4"	Open End, No Drive	100051B
100055B	Binder Post	3/8"	Open End, No Drive	100052B
100056B	Binder Post	1/2"	Closed End, No Drive	100052B
100057B	Binder Post	5/8"	Closed End, No Drive	100052B
100058B	Binder Post	3/4"	Closed End, No Drive	100052B
100060B	Binder Post	1"	Closed End, No Drive	100052B
100061B	Binder Post	1-1/4"	Closed End, No Drive	100052B
100062B	Binder Post	1-1/2"	Closed End, No Drive	100052B
100063B	Binder Post	1-3/4"	Closed End, No Drive	100052B
100064B	Binder Post	2"	Closed End, No Drive	100052B

Brass Binder Post & Screws 8-32

Our most popular sizes of binder posts and screws in bright solid brass material. Each brass post assembly consists of one post and one screw. Low profile, matching head on both the post and the screw allow for a nice clean look. Binding capacity is determined by length of post used.

- Post and screw sold separately
- Female posts are .203" dia. x .415" head O.D. – unslotted
- Male screws are 8-32 thread dia. x .415" head O.D. – slotted
- For use in 7/32" holes
- Not for use with #100049 PermaLock Screw
- Additional lengths available upon request
- Solid brass material
- Parts are passivated and waxed to help prevent tarnishing

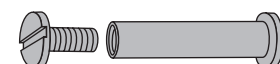

ITEM #	DESCRIPTION	LENGTH	HEAD TYPE	MATING SCREW (SOLD SEPARATELY)
100350	Removable Screw	3/16"	Slotted Drive	n/a
100351	Removable Screw	1/4"	Slotted Drive	n/a
100342	Removable Screw	5/16"	Slotted Drive	n/a
100348	Binder Post	1/8"	Open End, No Drive	100350
100353	Binder Post	3/16"	Open End, No Drive	100351
100354	Binder Post	1/4"	Open End, No Drive	100351
100347	Binder Post	3/8"	Closed End, No Drive	100342
100356	Binder Post	1/2"	Closed End, No Drive	100342
100357	Binder Post	5/8"	Closed End, No Drive	100342
100358	Binder Post	3/4"	Closed End, No Drive	100342
100360	Binder Post	1"	Closed End, No Drive	100342
100361	Binder Post	1-1/4"	Closed End, No Drive	100342
100362	Binder Post	1-1/2"	Closed End, No Drive	100342
100363	Binder Post	1-3/4"	Closed End, No Drive	100342
100364	Binder Post	2"	Closed End, No Drive	100342

Steel Binder Post & Screws 8-32

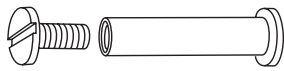

Each binder post assembly consists of one post and one screw. Low profile, matching head on both the post and the screw allow for a nice clean look. Steel material is much stronger and more durable than aluminum post and screws. Binding capacity is determined by length of post used. Use one of two steel screws for standard, removable applications. Use #100049 for rapid permanent assemblies.



- Post and screw sold separately
- Steel, zinc plated female posts are .203" dia. x .415" head O.D. – unslotted
- Steel, zinc plated male screws are 8-32 thread dia. x .415" head O.D. – slotted
- For use in 7/32" holes

ITEM #	DESCRIPTION	LENGTH	MATERIAL	HEAD TYPE	MATING SCREW (SOLD SEPARATELY)
100151	Removable Screw	1/4"	Steel	Slotted Drive	n/a
100152	Removable Screw	3/8"	Steel	Slotted Drive	n/a
100049	PermaLock Screw	3/8"	Nickel Plated Steel	Unslotted Tap-In *	n/a
100153	Binder Post	3/16"	Steel	Open End, No Drive	100151
100154	Binder Post	1/4"	Steel	Open End, No Drive	100151
100147	Binder Post	3/8"	Steel	Closed End, No Drive	100151
100156	Binder Post	1/2"	Steel	Closed End, No Drive	100152
100157	Binder Post	5/8"	Steel	Closed End, No Drive	100152
100158	Binder Post	3/4"	Steel	Closed End, No Drive	100152
100160	Binder Post	1"	Steel	Closed End, No Drive	100152
100161	Binder Post	1-1/4"	Steel	Closed End, No Drive	100152
100162	Binder Post	1-1/2"	Steel	Closed End, No Drive	100152
100163	Binder Post	1-3/4"	Steel	Closed End, No Drive	100152
100164	Binder Post	2"	Steel	Closed End, No Drive	100152

* #100049 PermaLock Screw works with aluminum and steel posts only – not brass

Stainless Steel Binder Post & Screws 8-32

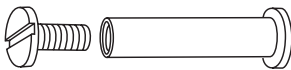

Each binder post assembly consists of one post and one screw. Low profile, matching head on both the post and the screw allow for a clean, corrosion-resistant look. Binding capacity is determined by length of post used. Use in conjunction with one of two stainless steel screws offered below.



- Post and screw sold separately
- Stainless steel female posts are .203" dia. x .415" head O.D. – unslotted
- Stainless steel male screws are 8-32 thread dia. x .415" head O.D. – slotted
- For use in 7/32" holes
- 18-8 (SS302-SS304) stainless steel material

ITEM #	DESCRIPTION	LENGTH	HEAD TYPE	MATING SCREW (SOLD SEPARATELY)
100451	Removable Screw	1/4"	Slotted Drive	n/a
100452	Removable Screw	3/8"	Slotted Drive	n/a
100453	Binder Post	3/16"	Open End, No Drive	100451
100454	Binder Post	1/4"	Open End, No Drive	100451
100447	Binder Post	3/8"	Closed End, No Drive	100451
100456	Binder Post	1/2"	Closed End, No Drive	100452
100457	Binder Post	5/8"	Closed End, No Drive	100452
100458	Binder Post	3/4"	Closed End, No Drive	100452
100460	Binder Post	1"	Closed End, No Drive	100452
100461	Binder Post	1-1/4"	Closed End, No Drive	100452
100462	Binder Post	1-1/2"	Closed End, No Drive	100452
100463	Binder Post	1-3/4"	Closed End, No Drive	100452
100464	Binder Post	2"	Closed End, No Drive	100452

Steel Barrel Bolts & Screws 10-24

Low profile, matching head on both the bolt and screw allow for a nice clean look. Zinc plated steel is much stronger than common aluminum binder posts. Each barrel bolt assembly consists of one bolt and one screw. Binding capacity is determined by length of barrel bolt used. Otherwise known as Sex Bolts or Chicago Screws.

- Barrel bolt and screw sold separately
- Female bolts are .250" dia. x .438" head O.D. – Slotted/Phillips combination
- Male screws are 10-24 thread dia. x .438" head O.D. – Slotted/Phillips combination
- For use in 17/64" holes
- Additional lengths available upon request
- Zinc plated steel material

ITEM #	DESCRIPTION	LENGTH	HEAD TYPE
100242	Removable Screw	5/16"	Combo Drive
100254	Barrel Bolt	1/4"	Open End, Slotted Drive
100255	Barrel Bolt	3/8"	Closed End, Combo Drive
100256	Barrel Bolt	1/2"	Closed End, Combo Drive
100257	Barrel Bolt	5/8"	Closed End, Combo Drive
100258	Barrel Bolt	3/4"	Closed End, Combo Drive
100260	Barrel Bolt	1"	Closed End, Combo Drive
100261	Barrel Bolt	1-1/4"	Closed End, Combo Drive
100262	Barrel Bolt	1-1/2"	Closed End, Combo Drive
100264	Barrel Bolt	2"	Closed End, Combo Drive

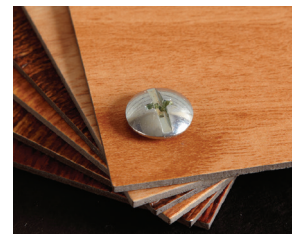
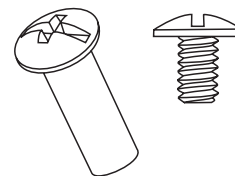

We can paint the heads of your barrel bolts & screws to match an exact color.

Steel Barrel Bolt Extension 10-24

When used in conjunction with Steel Barrel Bolts, extensions add length in order to increase binding capacity as needed.

- .250" barrel diameter
- 10-24 thread diameter on both male and female ends
- For use in 17/64" holes
- Zinc plated steel material

ITEM #	EXTENSION LENGTH
100231	1/2"



Stainless Steel Barrel Bolts & Screws 10-24

Low profile, matching head on both the bolt and screw allow for a nice clean look. Stainless steel material will not corrode or rust, unlike common steel zinc-plated barrel bolts and screws. Each barrel bolt assembly consists of one bolt and one screw. Binding capacity is determined by length of barrel bolt used. Otherwise known as Sex Bolts or Chicago Screws.

- Barrel bolt and screw sold separately
- Female bolts are .250" dia. x .438" head O.D. – Slotted/Phillips combination
- Male screws are 10-24 thread dia. x .438" head O.D. – Slotted/Phillips combination
- For use in 17/64" holes
- Additional lengths or barrel bolt extensions available upon request
- 18-8 (SS302-SS304) stainless steel material

ITEM #	DESCRIPTION	LENGTH	HEAD TYPE
100642	Removable Screw	5/16"	Combo Drive
100654	Barrel Bolt	1/4"	Open End, Slotted Drive
100655	Barrel Bolt	3/8"	Closed End, Combo Drive
100656	Barrel Bolt	1/2"	Closed End, Combo Drive
100657	Barrel Bolt	5/8"	Closed End, Combo Drive
100658	Barrel Bolt	3/4"	Closed End, Combo Drive
100660	Barrel Bolt	1"	Closed End, Combo Drive
100661	Barrel Bolt	1-1/4"	Closed End, Combo Drive
100662	Barrel Bolt	1-1/2"	Closed End, Combo Drive
100664	Barrel Bolt	2"	Closed End, Combo Drive

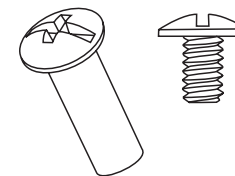

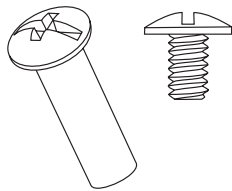

Steel Barrel Bolts & Screws 1/4-20

Low profile, matching head on both the bolt and screw allow for a nice clean look. Zinc plated steel is much stronger than common aluminum binder posts. Each barrel bolt assembly consists of one bolt and one screw. Binding capacity is determined by length of barrel bolt used. Otherwise known as Sex Bolts or Chicago Screws.

- Barrel bolt and screw sold separately
- Female bolts are .312" dia. x .562" head O.D. – Slotted/Phillips combination
- Male screws are 1/4-20 thread dia. x .562" head O.D. – Slotted/Phillips combination
- For use in 21/64" holes
- Additional lengths available upon request
- Zinc plated steel material



ITEM #	DESCRIPTION	LENGTH	HEAD TYPE
100742	Removable Screw	5/16"	Combo Drive
100755	Barrel Bolt	3/8"	Closed End, Combo Drive
100756	Barrel Bolt	1/2"	Closed End, Combo Drive
100757	Barrel Bolt	5/8"	Closed End, Combo Drive
100758	Barrel Bolt	3/4"	Closed End, Combo Drive
100760	Barrel Bolt	1"	Closed End, Combo Drive
100761	Barrel Bolt	1-1/4"	Closed End, Combo Drive
100762	Barrel Bolt	1-1/2"	Closed End, Combo Drive
100764	Barrel Bolt	2"	Closed End, Combo Drive

Rings & Binder Posts

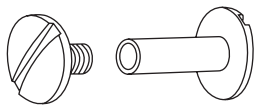

Rapid Assembly Plastic Binder Post & Screws 10-24

Large, low profile matching heads on both the post & screw allow for a nice, clean look. Screw can be pushed in for fast assembly. For best results, insert screw length completely. Removable and reusable. Each assembly consists of one post and one screw. Binding capacity is determined by length of post used. Otherwise known as Quick-Connect or Adjust-A-Locks.

- Post and screw sold separately
- Female posts are .240" barrel dia. x .562" head O.D.
- Male screws are 10-24 thread dia. x .562" head O.D.
- For use in 1/4" holes
- Plastic material
- Also available in clear



ITEM #	DESCRIPTION	LENGTH	COLOR	HEAD TYPE	MATING SCREW (SOLD SEPARATELY)
100551	Removable Screw	1/4"	White	Slotted Drive	n/a
100551B	Removable Screw	1/4"	Black	Slotted Drive	n/a
100550	Removable Screw	1/4"	White	No Drive	n/a
100552	Removable Screw	3/8"	White	Slotted Drive	n/a
100552B	Removable Screw	3/8"	Black	Slotted Drive	n/a
100545	Binder Post	1/4"	White	Closed End, Slotted Drive	100551
100545B	Binder Post	1/4"	Black	Closed End, Slotted Drive	100551B
100553	Binder Post	1/4"	White	Closed End, No Drive	100550
100547	Binder Post	3/8"	White	Closed End, Slotted Drive	100552
100547B	Binder Post	3/8"	Black	Closed End, Slotted Drive	100552B
100556	Binder Post	1/2"	White	Closed End, Slotted Drive	100552
100556B	Binder Post	1/2"	Black	Closed End, Slotted Drive	100552B
100558	Binder Post	3/4"	White	Closed End, Slotted Drive	100552
100558B	Binder Post	3/4"	Black	Closed End, Slotted Drive	100552B

Pear Clips

Strong construction. Clips totally shut for secure closure. Also known as Shower Curtain Rings or Golf Towel Clips.

- 2-1/2" length
- 1-3/8" diameter inside loop

ITEM #	MATERIAL	WIRE DIAMETER
101001	Zinc Plated Steel	.080"
101008	Brass Plated Steel	.080"
101009	Stainless Steel	.090"

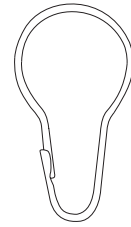

Roller Style Pear Clip

Pear shaped roller ball shower curtain ring. Curved top design rolls virtually friction-free across metal or wood rods. Great for display booths or partition fixtures requiring a drape or curtain. Reduces the possibility of curtains ripping. Clips totally shut for a secure closure.

- For use on up to 1-3/16" diameter rods or dowels
- 1-3/8" inside loop diameter
- Five 5/16" diameter free spinning roller balls centered along the top
- Solid brass with nickel plate
- Packaged 100 per bag

ITEM #	OVERALL LENGTH	WIRE DIAMETER
101010	2-3/4"	.085"

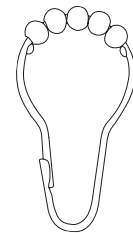

Aluminum Roller Hook

Open style, pear-shaped curtain roller hook. Curved shape top design with integrated nylon wheels that rolls virtually friction-free across metal or wooden rods. Great for display booths or partition fixtures requiring a drape or curtain. Reduces the possibility of curtains ripping. Open hook design that will not rust or corrode.

- For use on up to 7/8" diameter rods or dowels
- Two 1/2" outside diameter natural nylon roller wheels
- 9/32" bottom hook opening
- Aluminum material

ITEM #	OVERALL LENGTH	WIRE DIAMETER
101011	3-3/8"	.148"



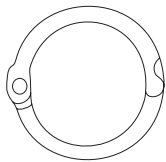

Hinged Snap Rings

Hinged design snaps easily and locks securely. Multipurpose rings. Also known as Loose Leaf Rings, Book Rings or Hinged Key Rings. **Warning:** Small sizes may be difficult to open.

- Standard nickel plated steel or special brass plated steel
- Packaged as shown below



ITEM #	I.D.	WIRE DIAMETER	FINISH	PACKAGED
101015	1/2"	.079"	Nickel	200 per bag
101002	3/4"	.091"	Nickel	200 per bag
101017	3/4"	.091"	Brass	200 per bag
101003	1"	.109"	Nickel	200 per bag
101018	1"	.109"	Brass	200 per bag
101016	1-1/4"	.109"	Nickel	100 per bag
101004	1-1/2"	.118"	Nickel	100 per bag
101019	1-1/2"	.118"	Brass	100 per bag
101005	2"	.118"	Nickel	50 per bag
101006	2-1/2"	.130"	Nickel	50 per bag
101007	3"	.170"	Nickel	10 per bag



We can paint your rings to match an exact color.

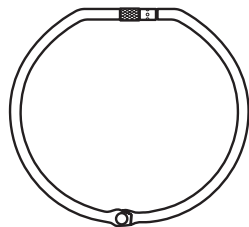

Screw Lock Rings

Strong, multipurpose oversized rings are well suited for bulky loose leaf material, swatches or samples. Hinged design and threaded locking device hold securely.

- Nickel plated steel



ITEM #	I.D.	WIRE DIAMETER
101052	2"	.156"
101053	3"	.203"
101054	4"	.203"
101055	5"	.203"
101056	6"	.203"
101057	7"	.218"
101058	8"	.218"
101060	10"	.218"

Ring Handles

Use in conjunction with metal Hinged Snap Rings or Screw Lock Rings to hold bulky loose leaf material, samples or swatches. 1/4" diameter wire is very strong. Three popular lengths to choose from.

- Length of handle is measured from inside of loop to inside of loop
- .250" diameter nickel plated steel



ITEM #	LENGTH
101037	7"
101039	9"
101040	10"

Plastic Snap Ring

Economical multi-use connector link. Easy to use one piece snap closure design. Simply press closed for hanging of signs from wire fixtures or to make lightweight sample swatches.

- 5/8" open I.D.
- 9/16" I.D. x 7/8" O.D. ring when closed

ITEM #	COLOR	MATERIAL
101025	White	Polyethylene
101025B	Black	Polyethylene
101025C	Clear	Polycarbonate

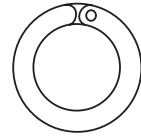

Plastic Spiral Ring

Coiled style economical multi-use connector link. Overlap spiral design is easy to use and offers memory closure. Great for hanging signs from wire fixtures or to create lightweight sample swatches and flip charts.

- 11/16" I.D. x 13/16" O.D.
- .094" diameter rigid PVC material
- Packaged 250 per bag

ITEM #	COLOR
101026	White
101026C	Clear

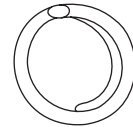

Plastic Overlap Ring

Round overlap style split ring design is easy to use and offers memory closure. A quick way to hang signs from wire fixtures or to create lightweight sample swatches and flip charts.

- 3/4" I.D. x 1" O.D.
- Packaged 250 per bag

ITEM #	COLOR	MATERIAL
101027	White	High Impact Plastic
101027C	Clear	Polycarbonate

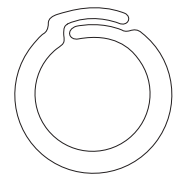

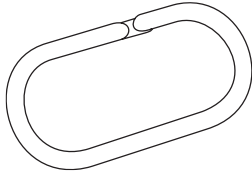

Plastic Oval Snap Ring

Economical, multi-use connector link with easy to use, one piece snap closure design. Simply press closed for hanging of signs evenly and straight one below the other, or to attach advertisements to wire fixtures. Snaps closed to create an oval shaped ring.

- 15/16" wide x 2" long inside dimension x .156" diameter
- Packaged 100 per bag



ITEM #	COLOR	MATERIAL
101028	White	Polyethylene
101028C	Clear	ABS

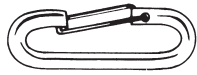

Bit Snap Link

Oval shaped, spring snap closed design connector that offers multiple uses. Securely link or hang most anything light duty. **Warning:** Not designed for lifting.

- .192" wire diameter
- 7/32" snap opening
- Zinc plated steel



ITEM #	LENGTH
101075	1-3/4"

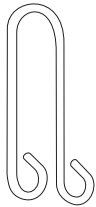

"U" Hook

In conjunction with Binder Post & Screws (up to 3/4" long – see page 226-230), "U" Hooks are popular for use on foam board and other thick sign material. Also used to attach two sign panels back to back, or for holding sample swatches. Binder Post & Screws are sold separately.

- 2" overall length x 3/4" wide
- 1/4" I.D. looped ends
- .093" wire diameter, bright galvanized steel
- Packaged 100 per bag

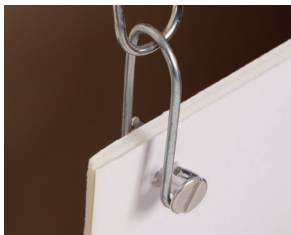

ITEM #	LENGTH	MAX. MATERIAL THICKNESS
106002	2"	3/4"

Rings & Binder Posts

With one of the largest inventories of binder posts and barrel bolts in the US, as well as many popular ring choices, we are your choice for low-cost bindery hardware.



**Ceiling Systems
& Accessories**



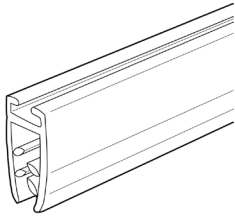

Gripper Atlas Banner Hanger

A simple and economical way to hang signs and banners. Gripper fins hold heavier or longer length signs securely. Can also be used on the bottom edge of banners or posters to stabilize or keep straight. Removable and reusable.

- "U" shaped design with two grip sizes available
- Overall height is 9/16" for smaller capacity and 3/4" for larger capacity
- Top accepts either our #110503 or #110506 series hanger clips (sold separately)
- Gripper fins on bottom hold sign materials firm
- PVC material
- Also available in black

ITEM #	GRIP CAPACITY	OVERALL LENGTH	COLOR
110800	.015" to .080"	22"	Clear
110801	.015" to .080"	24"	Clear
110802	.015" to .080"	36"	Clear
110803	.015" to .080"	48"	Clear
110808	.125" to .250"	22"	Clear
110809	.125" to .250"	36"	Clear
110810	.125" to .250"	48"	Clear

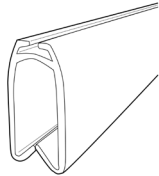

Atlas Banner Hanger

Economical way to dress up lightweight signs and banners with a smooth, contemporary elegance. Slides directly onto the top or bottom edges of banners or posters for a secure friction fit. Stiffens and stabilizes as well. Removable and reusable.

- 1" height x 1/2" width
- Top accepts either our #110503 or #110506 series hanger clips (sold separately)
- Available in custom lengths or colors
- PVC material
- Also available in clear

ITEM #	GRIP CAPACITY	OVERALL LENGTH	COLOR
110600W	up to .125"	22"	White
110601W	up to .125"	24"	White
110602W	up to .125"	36"	White
110603W	up to .125"	48"	White
110603B	up to .125"	48"	Black

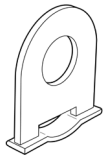

Banner Hanger Clip

For use in conjunction with both our Gripper Atlas and Apollo Banner Hangers (sold separately). Provides an adjustable hanging point by sliding into the top track of either hanger. **Warning:** Not recommended for use with barbed cords unless cord is tied to the center hole.

- 11/16" wide x 3/4" height x .050" thick with curved top
- 5/16" diameter center hole

ITEM #	COLOR	MATERIAL
110503	Clear	Polycarbonate
110503B	Black	Nylon
110503W	White	Nylon

Gripper Apollo Banner Hanger

Add ever-changing advertisements anywhere with little cost. Designed to quickly and easily attach a banner to the hanger: just snap up to open, insert sign and snap down to close. Integrated soft gripper fingers hold signs firm, with two internal overlapping rails for an extra snug fit.

- 3/4" height "U" shaped square design
- Top accepts either our #110503 or #110506 series hanger clips (sold separately)
- Bottom has a hinged/snap-shut gripper fin section
- Clear PVC material
- Available in custom lengths or colors
- Also available with adhesive (see page 95)

ITEM #	GRIP CAPACITY	OVERALL LENGTH	COLOR
110700	up to .040"	22"	Clear
110701	up to .040"	24"	Clear
110702	up to .040"	36"	Clear
110703	up to .040"	48"	Clear
110703B	up to .040"	48"	Black

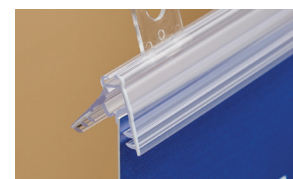
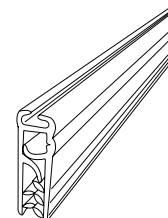

Gripper Apollo Designer Series Banner Hanger

Add ever-changing advertisements with an upscale, elliptical-shaped designer look. Designed to quickly and easily attach a banner to the hanger: just snap up to open, insert sign and snap down to close. Integrated soft gripper fins hold signs firm.

- 13/16" height elliptical-shaped design
- Top accepts either our #110503 or #110506 series hanger clips (sold separately)
- Bottom has a hinged/snap-shut gripper fin section
- PVC material
- Custom lengths or colors also available

ITEM #	GRIP CAPACITY	OVERALL LENGTH	COLOR
110740	up to .060"	22"	Clear
110740B	up to .060"	22"	Black
110741	up to .060"	24"	Clear
110741B	up to .060"	24"	Black
110742	up to .060"	36"	Clear
110742B	up to .060"	36"	Black
110742W	up to .060"	36"	White
110743	up to .060"	48"	Clear
110743B	up to .060"	48"	Black
110743W	up to .060"	48"	White

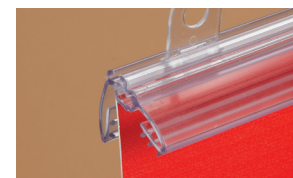
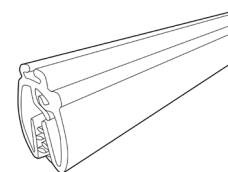

Banner Hanger Clip With Hook

For use in conjunction with any of our Atlas or Apollo Banner Hangers (sold separately). Provides an adjustable hanging point by sliding into the top track of the hanger. Hook style allows for a wider variety of hanging options. **Warning:** Not recommended for use with barbed cords unless cord is tied to the top of the clip.

- 11/16" wide x 3/4" height x .150" thick with curved top
- 5/16" diameter center area with .060" wide hook opening

ITEM #	COLOR	MATERIAL
110506	Clear	Polycarbonate
110506B	Black	Nylon
110506W	White	Nylon



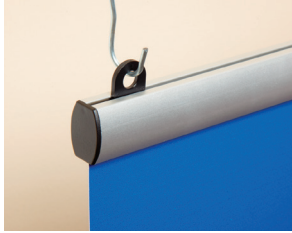
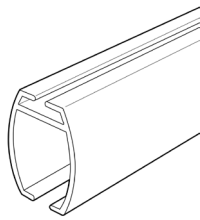

Elliptical Banner Hanger – Aluminum

Dress up signs and banners, both large and small, with classic upscale elegance. Grips and displays permanent or semi-permanent advertisements securely and easily. Pick an internal holder option (sold separately), attach to edge of graphic and slide holder into lightweight aluminum hanger – it's that easy! Optional accessories include inserts, joiners, hanger clips and end caps. Also works great with common 1/4" to 1/2" hemmed wooden or plastic banner dowel rods (see pages 248-249).

- 1" height x 3/4" width
- Holds a wide range of sign materials
- Various holder insert options (sold separately)
- Other lengths available
- Silver satin anodized aluminum material
- Also available in anodized black

ITEM #	GRIP CAPACITY	OVERALL LENGTH	COLOR
110023	up to .187"	24"	Silver
110024	up to .187"	36"	Silver
110025	up to .187"	48"	Silver



Elliptical End Cap

When inserted into the ends of our aluminum Elliptical Banner Hanger (sold separately), these end caps provide the finishing touch needed for an elegant, upscale appearance.

- 1" height x 3/4" width
- Textured face
- Elliptical shape
- Male insert pin is 1/2" long
- Black nylon 6/6 material

ITEM #	FOR USE WITH
110500B	Elliptical Banner Hanger – Aluminum

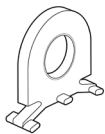

Elliptical Banner Hanger Clip

For use in conjunction with our aluminum or plastic Elliptical Banner Hangers (sold separately). Provides an adjustable hanging point by sliding into the top track of the hanger. **Warning:** Not recommended for use with barbed cords.

- 11/16" wide x 5/8" height x .100" thick with curved top
- 5/16" diameter center hole

ITEM #	COLOR	MATERIAL
110502	Clear	Polycarbonate
110502B	Black	Nylon

Aluminum Banner Joiner Hanger Clip

For use in conjunction with our Elliptical Aluminum Banner hangers (sold separately). Dual use part that provides both a hanging point for support and a means of joining together two or more of our Elliptical Aluminum Banner Hanger housings. **Warning:** Not recommended for use with barbed cords.

- Two 1-1/4" long male insert pins with a 11/16" wide hanging clip in the middle
- 5/8" tall hanging clip has a curved top
- 5/16" diameter center hole
- Black acetal material

ITEM #	OVERALL LENGTH	FOR USE WITH
110504B	3"	Elliptical Banner Hanger – Aluminum

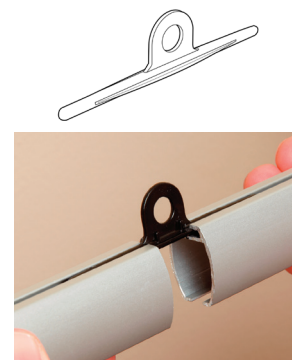

Graphic Ratchet Fastener

One of several internal holder options that can act as a cross member when two pieces are pressed together along the top edge of a graphic. Permanent and not removable from graphic. Grip capacity can accommodate any sign material up to .187" thick – perfect for use with our Aluminum Elliptical Banner Hanger (sold separately).

- Complete assembly requires two pieces
- Fits into .281" diameter hole size
- Natural nylon 6/6 material

ITEM #	HEAD O.D.	FOR SIGN THICKNESS
120305	.406"	up to .187"

Reminder: Complete assembly requires two pieces.

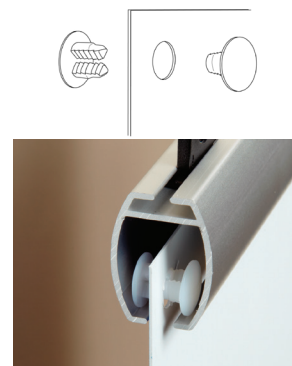

Gripper Sign Holder Insert

Two of several internal holder options that grip sign edges and act as a cross member. Simply press on to graphic edge and the gripper fins hold securely. Both are for use with our Aluminum Elliptical Banner Hanger (sold separately). Removable and reusable.

- 3" long x 1/2" height with base width of 1/2"
- Other lengths available upon request
- Clear PVC material

ITEM #	SIZE	FOR SIGN THICKNESS
108524	Standard	up to .080"
108532	Heavy Duty	.125" to .187"

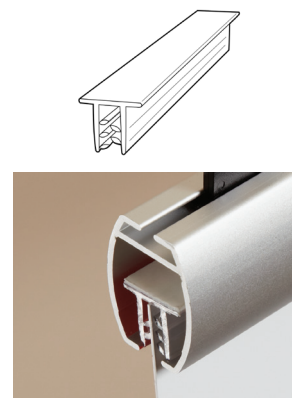

Gripper Apollo Insert

For use with our Aluminum Elliptical Banner Hanger (sold separately). One of several internal holder options that grip sign edges. Just snap up to open, insert sign and snap down to close – it's that easy. Removable and reusable. Integrated soft gripper fingers hold signs firm, with two internal overlapping rails for an extra snug fit.

- 11/16" height "U" shaped square design
- Hinged/snap-shut gripper fin section
- Clear PVC material

ITEM #	OVERALL LENGTH	FOR SIGN THICKNESS
110751	24"	up to .040"
110752	36"	up to .040"
110753	48"	up to .040"



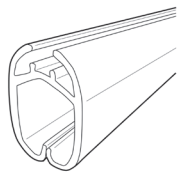

Elliptical Banner Hanger – Plastic

Economical way to dress up lightweight signs and banners with classic upscale elegance. Slides directly onto the top or bottom edges of banners or posters for a secure friction fit. Stiffens and stabilizes as well. Removable and reusable. **Note:** Our item #110500 series end cap does not work with this plastic elliptical banner hanger.

- 7/8" height x 5/8" width
- Top accepts our item #110502 series hanger clips (sold separately)
- Available in custom lengths and colors
- Clear PVC material
- Also available in silver, black and white



ITEM #	GRIP CAPACITY	OVERALL LENGTH	COLOR
110322C	up to .080"	22"	Clear
110324C	up to .080"	24"	Clear
110336C	up to .080"	36"	Clear
110348C	up to .080"	48"	Clear



Elliptical Banner Hanger Clip

For use in conjunction with our aluminum or plastic Elliptical Banner Hangers (sold separately). Provides an adjustable hanging point by sliding into the top track of the hanger. **Warning:** Not recommended for use with barbed cords.

- 11/16" wide x 5/8" height x .100" thick with curved top
- 5/16" diameter center hole



ITEM #	COLOR	MATERIAL
110502	Clear	Polycarbonate
110502B	Black	Nylon

Kinter's secondary operations and fulfillment resources include high-speed bagging & boxing, labeling & instructions, direct-to-store shipment, and co-packing with customer supplied parts.

Space General Banner Hanger

Add ever-changing advertisements with an upscale, round tubular appearance. Designed to quickly and easily attach a banner to the hanger: Just snap up to open, insert sign and snap down to close. Integrated soft gripper fins hold signs firm. Also great for displaying sewn/hemmed fabric or vinyl banners, banners with metal grommets or flags. Can also be placed along the bottom of banners for stability. Optional accessories include hanger clips and end caps.

- 1" O.D. round shape
- Top accepts either #110503 or #110506 series hanger clips (sold separately)
- Optional end caps provide a finished appearance (see below)
- PVC material
- Custom lengths or colors also available – please inquire

ITEM #	GRIP CAPACITY	OVERALL LENGTH	COLOR
110746	up to .125"	24"	Silver
110746C	up to .125"	24"	Clear
110746B	up to .125"	24"	Black
110747	up to .125"	36"	Silver
110747C	up to .125"	36"	Clear
110747B	up to .125"	36"	Black
110748	up to .125"	48"	Silver
110748C	up to .125"	48"	Clear
110748B	up to .125"	48"	Black

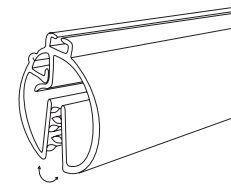

Space General End Cap

Smooth, plastic caps that provide the finishing touch for an elegant, upscale appearance to our Space General Banner Hanger (sold separately). Male insert pin slides into the hanging track for friction fit placement. Removable and reusable.

- Round cap measures 1" O.D.
- 5/64" thick
- Smooth face
- Friction fit male insert pin is 5/16" long
- Nylon 6/6 material

ITEM #	FOR USE WITH	COLOR
110508	Space General Banner Hanger	Silver
110508C	Space General Banner Hanger	Clear
110508B	Space General Banner Hanger	Black

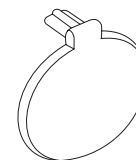

Space General Hanger Clip

For use in conjunction with our Space General Banner Hangers (sold separately). Provides an adjustable hanging point by sliding into the top track of the hanger. **Warning:** Not recommended for use with barbed cords unless cord is tied to the center hole.

- 11/16" wide x 3/4" height x .050" thick with curved top
- 5/16" diameter center hole

ITEM #	COLOR	MATERIAL
110503	Clear	Polycarbonate
110503B	Black	Nylon
110503W	White	Nylon



Space General Hanger Clip With Hook

For use in conjunction with our Space General Banner Hangers (sold separately). Provides an adjustable hanging point by sliding into the top track of the hanger. Hook style allows for a wider variety of hanging options. **Warning:** Not recommended for use with barbed cords unless cord is tied to the top of the clip.

- 11/16" wide x 3/4" height x .150" thick with curved top
- 5/16" diameter center area with .060" wide hook opening

ITEM #	COLOR	MATERIAL
110506	Clear	Polycarbonate
110506B	Black	Nylon
110506W	White	Nylon



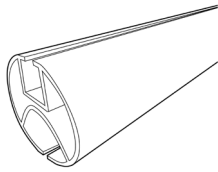

Round Graphic/Banner Hanger

A dramatic, tubular way to prominently dress up signs and banners, both large and small. Grips and displays permanent or semi-permanent overhead advertisements securely and easily. Pick an internal holder option (sold separately), attach to edge of graphic and slide holder into round housing – it's that easy! Optional accessories include inserts, joiners, hanger clips and end caps. Also works great with common 1/4" to 1/2" hemmed wooden or plastic dowel rods (see pages 248-249). Optional round PVC material can be shaped and joined to create circular, oval, curved or serpentine mobiles for high visual impact.



- 1-5/8" O.D. round shape
- Holds a wide range of sign materials
- Can also be used as a matching bottom edge stabilizer
- Custom colors, materials, lengths, shapes and/or mitered angle cuts also available
- Black high impact polystyrene (HIPS) material

ITEM #	GRIP CAPACITY	OVERALL LENGTH	STYLE
110017B	up to .125"	36"	Round
110018B	up to .125"	48"	Round
110019B	up to .125"	72"	Round



Round Graphic/Banner End Cap

When inserted into the ends of our Round Graphic/Banner Hanger (sold separately), these end caps provide the finishing touch needed for an upscale appearance.



- 1-5/8" I.D. x 1-7/8" O.D. round shape with slot
- 3/4" long integrated single male insert for friction fit
- Custom colors available
- Black polypropylene material

ITEM #	SIZE	FOR USE WITH
219011	1-5/8" I.D. – Round	Round Graphic/Banner Hanger



Round Graphic/Banner Hanger Clip

For use in conjunction with our Round Graphic/Banner Hanger (sold separately). Strong spring steel, zinc plated squeeze clip that provides an adjustable hanging point by sliding into the top track of the hanger. Use more than two hanger clips for long lengths or joined housings. Otherwise known as a "Kiwi" Clip.

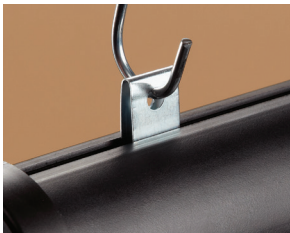

- .810" overall height x .500" wide
- .180" diameter center hole
- Friction fit
- .015" thick zinc plated spring steel
- Also available in black

ITEM #	WIDTH	FOR USE WITH
411203	1/2"	Round Graphic/Banner Hanger

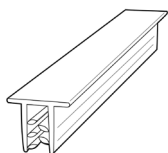

Gripper Sign Holder Insert

Two of several internal holder options that grip sign edges and act as a cross member. Simply press on to graphic edge and the gripper fins hold securely. Both are for use with our Round Graphic/Banner Hanger (sold separately).



- 3" long x 1/2" height with base width of 1/2"
- Other lengths available upon request
- Clear PVC material

ITEM #	SIZE	FOR SIGN THICKNESS
108524	Standard	up to .080"
108532	Heavy Duty	.125"

Double Barbed Graphic Fastener

Internal holder option that acts as a cross member when pressed into holes along the top or bottom edges of signs that then slide into extruded frames. Accommodate any sign material up to .125" thick – perfect for use with our Round Graphic/Banner Hanger (sold separately).

- Recommended spacing is one fastener per 12 inches
- Press fit into 5/32" sized pre-drilled/punched holes
- Center flange with standard .305" long X-Mas Tree style fins on each side
- Proper installation is when center flange is flush with sign panel
- Black 6/6 nylon material

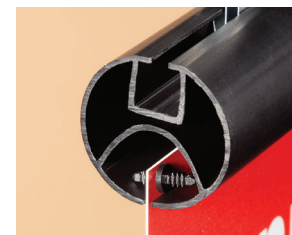
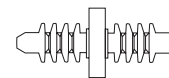

ITEM #	OVERALL LENGTH	FOR SIGN THICKNESS
120204B	.677"	up to .125"

Round or Square Economy Banner Joiner

An inexpensive, friction fit straight joiner that connects two or more Round or Square Graphic/Banner Hangers (sold separately). When centered, this joiner provides approximately 3 inches of internal connection/support. For added strength, the square profile can accept two joiners with one on each side (this double option is not available for the round profile). **Warning:** It is required to have a hanging point located near each joined section or sign frame may buckle.

- Designed for a straight, internal friction fit
- 1-3/8" height concave/curved design
- .030" thick black styrene material

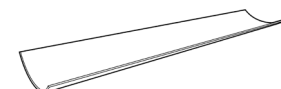

ITEM #	OVERALL LENGTH	FOR USE WITH
110505B	6"	either Round or Square Graphic/Banner Hanger

Heavy Duty Round Graphic/Banner Joiner

Loose fitting straight metal joiner that, when integrated set screws are tightened, securely connects two or more Round Graphic/Banner Hangers (sold separately). Simply center the joiner within the inner channel of the round housing, tighten the set screws with hex wrench (sold separately) and a heavy duty connection is complete. Don't forget to include the hex wrench in hardware kits where metal joiners are required. These angled wrenches are designed to fit and turn the integrated joiner set screws, and the long arm offers extra solid turning power. Added option: Remove one set screw and connect two plates together to create unlimited custom shapes and/or mitered angles. **Warning:** It is required to have a hanging point located near each joined section or sign frame may buckle.

- Joiner is 3" long x .323" wide x .070" thick tapped metal plate
- Pre-assembled with two 10-32 x 1/2" long cup point socket set screws
- Can also be used when joining a matching bottom stabilizer
- Not for use with our Square Graphic/Banner Hanger
- Can be ordered with two joiners connected together – please inquire
- Joiner is bright galvanized steel plate with black steel set screws
- Hex wrench is black oxide alloy steel, and has 3/4" long short arm & 3-1/2" long arm
- Wrench has 3/32" hex key size that fits the joiner's integrated 10-32 set screws

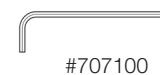

ITEM #	DESCRIPTION	FOR USE WITH
707205	Metal Joiner With Set Screws	Round Graphic/Banner Hanger
707100	Hex Wrench	Heavy Duty Round Graphic/Banner Joiner

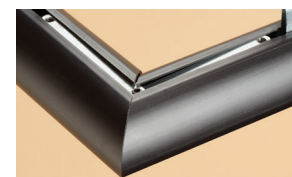

Connect two or more joiners together to create custom shapes

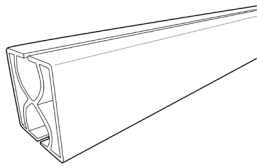

Square Graphic/Banner Hanger

A dramatic, tubular way to prominently dress up signs and banners, both large and small. Grips and displays permanent or semi-permanent overhead advertisements securely and easily. Pick an internal holder option (sold separately), attach to edge of graphic and slide holder into square housing – it's that easy! Optional accessories include inserts, joiners, hanger clips and end caps. Also works great with common 1/4" to 1/2" hemmed wooden or plastic dowel rods (see pages 248-249). Optional square PVC material can be shaped and joined to create circular, oval, curved or serpentine mobiles for high visual impact.

- 1-1/2" square shape
- Holds a wide range of sign materials
- Can also be used as a matching bottom edge stabilizer or to ladder one sign below the other
- Custom colors, materials, lengths, shapes and/or mitered angle cuts also available
- Black high impact polystyrene (HIPS) material

ITEM #	GRIP CAPACITY	OVERALL LENGTH	STYLE
110020B	up to .125"	36"	Square
110021B	up to .125"	48"	Square
110022B	up to .125"	72"	Square

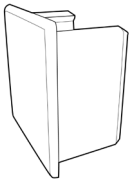

Square Graphic/Banner End Cap

When inserted into the ends of our Square Graphic/Banner Hanger (sold separately), these end caps provide the finishing touch needed for an upscale appearance.

- 1-1/2" square shape
- Textured face
- Two 3/4" long male insert legs
- Friction fit
- Custom colors available
- Black high impact polystyrene (HIPS) material

ITEM #	SIZE	FOR USE WITH
187112	1-1/2" Square	Square Graphic/Banner Hanger



Square Graphic/Banner Hanger Clip

For use in conjunction with our Square Graphic/Banner Hanger (sold separately). Provides an adjustable hanging point by sliding into the top track of the hanger. Use more than two hanger clips for long lengths or joined housings.

- 1-1/16" wide x 1" height x .080" thick with angled/curved top
- 7/32" diameter center hole
- Friction fit
- Custom colors available
- Black nylon 6/6 material

ITEM #	WIDTH	FOR USE WITH
187561	1-1/16"	Square Graphic/Banner Hanger

Double Barbed Graphic Fastener

Internal holder option that acts as a cross member when pressed into holes along the top or bottom edges of signs that then slide into extruded frames. Accommodate any sign material up to .125" thick – perfect for use with our Square Graphic/Banner Hanger (sold separately).

- Recommended spacing is one fastener per 12 inches
- Press fit into 5/32" sized pre-drilled/punched holes
- Center flange with standard .305" long X-Mas Tree style fins on each side
- Proper installation is when center flange is flush with sign panel
- Black 6/6 nylon material

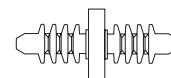

ITEM #	OVERALL LENGTH	FOR SIGN THICKNESS
120204B	.677"	up to .125"

Round or Square Economy Banner Joiner

An inexpensive, friction fit straight joiner that connects two or more Round or Square Graphic/Banner Hangers (sold separately). When centered, this joiner provides approximately 3 inches of internal connection/support. For added strength, the square profile can accept two joiners with one on each side (this double option is not available for the round profile). **Warning:** It is required to have a hanging point located near each joined section or sign frame may buckle.

- Designed for a straight, internal friction fit
- 1-3/8" height concave/curved design
- .030" thick black styrene material

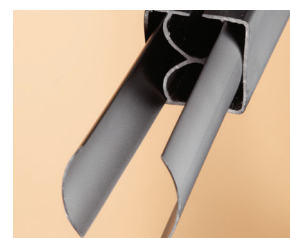
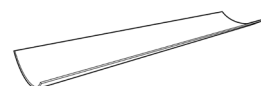

ITEM #	OVERALL LENGTH	FOR USE WITH
110505B	6"	either Round or Square Graphic/Banner Hanger

Gripper Sign Holder Insert

Two of several internal holder options that grip sign edges and act as a cross member. Simply press on to graphic edge and the gripper fins hold securely. Both are for use with our Square Graphic/Banner Hanger (sold separately).

- 3" long x 1/2" height with base width of 1/2"
- Other lengths available upon request
- Clear PVC material

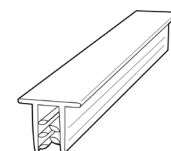

ITEM #	SIZE	FOR SIGN THICKNESS
108524	Standard	up to .080"
108532	Heavy Duty	.125"

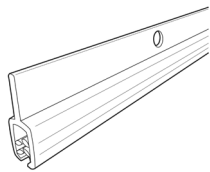

Gripper Simple Banner Hanger

A simple and economical way to hang signs and banners. Gripper fins hold heavier or longer length signs securely. Unlike other banner hangers, this simple hanger has integrated holes and is a one-piece design: thus; no need for hanger clips, clamps or adapters. Removable and reusable.

- 3/4" overall height
- 5/32" diameter hanging holes
- Gripper fins on bottom hold sign materials firm
- Custom lengths and colors available
- PVC material



ITEM #	GRIP CAPACITY	LENGTH	COLOR
110850	.015" to .080"	22"	Clear
110851	.015" to .080"	24"	Clear
110852	.015" to .080"	36"	Clear
110853	.015" to .080"	48"	Clear
110853B	.015" to .080"	48"	Black

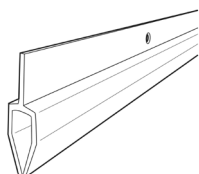

Simple Banner Hanger

Our simplest and most economical way to hang signs and banners. Slides directly onto the top edge of lightweight banners or posters. Unlike other banner hangers, this simple hanger has integrated holes and is a one-piece design: thus; no need for hanger clips, clamps or adapters.

- 13/16" height angled "U" shaped pinched design
- 1/8" diameter hanging holes
- Custom lengths and colors available



ITEM #	GRIP CAPACITY	LENGTH	COLOR	MATERIAL
110825	up to .125"	22"	Clear	Butyrate
110825W	up to .125"	22"	White	Styrene
110826	up to .125"	24"	Clear	Butyrate
110826W	up to .125"	24"	White	Styrene
110827	up to .125"	36"	Clear	Butyrate
110827W	up to .125"	36"	White	Styrene
110828	up to .125"	48"	Clear	Butyrate
110828W	up to .125"	48"	White	Styrene

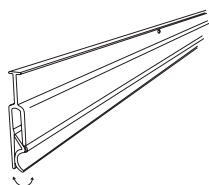

Snap-Shut Banner Hanger

Hang ever-changing signs in seconds with this simple, snap-shut design. Just snap it open, insert sign and snap down to close. Unlike other banner hangers, this hanger has integrated holes and is a one-piece design; thus, no need for hanger clips, clamps or adapters. Removable and reusable.

- 1-1/8" overall height
- 5/32" diameter hanging holes
- Snap-shut feature holds sign materials firm
- Clear PVC material
- Custom lengths and colors available



ITEM #	GRIP CAPACITY	LENGTH	COLOR
110731	up to .040"	24"	Clear
110732	up to .040"	36"	Clear
110733	up to .040"	48"	Clear



Gripper Budget Banner Hanger/Stabilizer

Grips directly onto the edge of lightweight banners or posters to keep straight. Can be used as an economical banner hanger when combined with our Valance Clip (sold separately – see below). Add weight to banner edges or bottoms to stiffen and stabilize. Removable and reusable.

- 3/8" height with 1/4" base width
- Gripper fins hold sign materials firm
- Custom lengths and colors available
- PVC material
- Also available in white

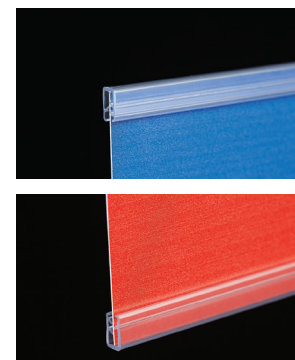
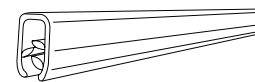

ITEM #	GRIP CAPACITY	LENGTH	COLOR
110811	.015" to .080"	22"	Clear
110812	.015" to .080"	24"	Clear
110813	.015" to .080"	36"	Clear
110814	.015" to .080"	48"	Clear
110814B	.015" to .080"	48"	Black

Budget Banner Hanger/Stabilizer

Slides directly onto the edge of lightweight banners or posters to keep straight. Can be used as an economical banner hanger when combined with our Valance Clip (sold separately – see below). Add weight to banner edges or bottoms to stiffen and stabilize. Economical, removable and reusable.

- 1/2" height angled "U" shaped pinched edging
- Holds signs up to 1/8" thick
- Available in custom lengths
- Clear or white PVC material
- Also available in black

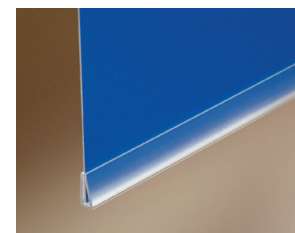
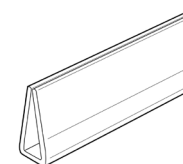

ITEM #	LENGTH	COLOR
110804	22"	Clear
110805	24"	Clear
110806	36"	Clear
110806W	36"	White
110807	48"	Clear
110807W	48"	White

Valance Clip

For use in conjunction with both our Budget Banner Hanger/Stabilizer and our Gripper Budget Banner Hanger/Stabilizer (sold separately). Provides an adjustable hanging point by sliding into the edge of either hanger. **Warning:** Not recommended for use with barbed cords unless cord is tied directly to the center slot.

- 27/32" wide x 1-3/16" height x .050" thick with curved top
- 7/32" diameter tapered center slot
- Packaged 500 per bag

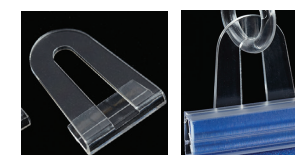

ITEM #	COLOR	MATERIAL
110507	Clear	Polycarbonate

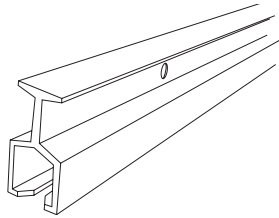

Vinyl Graphic Banner Hanger Track

Are you tired of bowed, wavy or flimsy vinyl banner presentations when hung from traditional wooden dowels or strung from metal grommets? If so, we have the solution! This ingenious banner hanger track displays sewn/hemmed vinyl, fabric or paper graphics in a dramatic straight, crisp and level manner. Simply slide our Plastic Vinyl Graphic Banner Dowel Rod (sold separately – see below) into the sleeve of an edge sewn graphic and then into the inside track – it's that easy. For longer lengths, use two or more plastic dowel rods end to end. **Patent Pending.**

- Features a handy V-notch entryway to help banners slide in
- 1/2" wide x 7/8" overall height
- Use with end caps (sold separately) for a clean, finished appearance
- Three 3/16" diameter hanging holes (two end holes and one center hole)
- Custom lengths and colors available – please inquire
- White PVC material



ITEM #	LENGTH	MATING PLASTIC ROD (SOLD SEPARATELY)
220220	24"	1 pc of 220201
220221	26"	1 pc of 220202
220222	36"	1 pc of 220203
220223	48"	1 pc of 220200
220225	72"	2 pcs of 220203

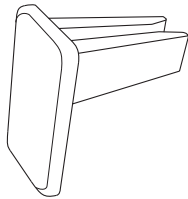

Banner Hanger Track End Cap Retainer

Friction fits directly onto the neck area of our line of Vinyl Graphic Banner Hanger Tracks. Provides a decorative end "stop" that helps retain our Plastic Vinyl Graphic Banner Dowel Rods within the "C" channel bottom track.

- 7/8" height x 1/2" width
- External legs are 3/4" long
- Textured face
- Rectangular shape
- White polycarbonate material



ITEM #	FOR USE WITH
220005W	Vinyl Graphic Banner Hanger Tracks

Plastic Vinyl Graphic Banner Dowel Rod

Use to economically display sewn/hemmed fabric or vinyl banners. Simply slide this round rigid plastic dowel into the sleeve of an edge sewn graphic and then into the inside track of our Vinyl Graphic Banner Hanger Track. Also works great with our Elliptical Aluminum Hanger (sold separately) or our Round and Square Plastic Hangers (also sold separately). Unlike wooden dowels, plastic dowels are extruded smooth with no chance of splinters or splinters. For longer lengths, use two or more dowels end to end.

- 1/4" diameter solid rigid dowel
- Use with end caps (sold separately) for a clean, finished appearance
- Dowels are always produced 1/8" shorter than below stated lengths to assure a proper fit
- Custom lengths available – please inquire
- White acrylic material

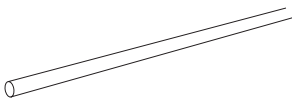

ITEM #	LENGTH	DIAMETER	COLOR
220201	24"	1/4"	White
220202	26"	1/4"	White
220203	36"	1/4"	White
220200	48"	1/4"	White

Wooden Banner Dowel Rods

A simple, inexpensive way to support signs and displays horizontally from exposed ceilings, walls or windows. Great for displaying sewn/hemmed fabric or vinyl banners. Simply slide this round, rigid wood dowel into the top and/or bottom sleeve of an edge sewn graphic. Can be combined with Pear Clips, Snap Rings or Screw Eyes/Eyelets (sold separately) to hang signs in place. Also can be used as a stabilizer for bottom sewn/hemmed banners. **Warning:** Not recommended for the combined use of both barbed cords and screw eyes/eyelets unless the cord is tied directly to the screw eye.

- For an additional charge, end holes can be pre-drilled and/or screw eyes/eyelets inserted – please inquire
- Additional hanging accessories available such as rigid plastic End Caps and Screw Eyes (sold separately – see below)
- Three common diameters to choose from
- Other lengths and diameters available – please inquire
- Premium natural poplar or birch hardwood – kiln dried
- Sold in full bundles only



ITEM #	LENGTH	DIAMETER	BUNDLE QUANTITY
411211	36"	3/8"	100 pieces
411215	36"	1/2"	50 pieces
411216	48"	1/2"	50 pieces
411221	48"	3/4"	25 pieces

Wooden Banner Dowel Joiner

For use in conjunction with our Wooden Banner Dowel Rods (sold separately). Provides a sturdy joining option for two or more of the same diameter dowels, or easy breakdown for shipping purposes. Create wider banner displays or maximize horizontal space. Strong, friction-fit connector design.

Warning: Because wood naturally takes on or gives off moisture, joiners may tend to seasonally fit tightly or loosely.

- Double ended, friction-fit design
- Both sizes have an overall length of 2-9/16"
- Natural translucent polypropylene material
- Other sizes and colors available – please inquire

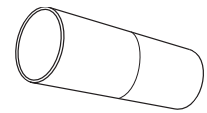

ITEM #	FOR USE WITH	OVERALL LENGTH
411236	1/2" dia. Wooden Banner Dowel Rods	2-9/16"
411237	3/4" dia. Wooden Banner Dowel Rods	2-9/16"

Wooden Banner Dowel End Cap

For use in conjunction with our Wooden Banner Dowel Rods (sold separately). Provides both a sturdy hanging point and a decorative finishing touch when slid onto the ends of common round wooden dowels. Works great with many common hanging hardware options such as metal hooks or barbed cords. Strong friction fit design. **Warning:** Not recommended for use with barbed cords unless cord is tied to the end hole. Further, because wood naturally takes on or gives off moisture, end caps may tend to fit tightly or loosely.

- Both the 3/8" and 1/2" diameters have an overall length of 1-5/16" and a hole size of 3/16"
- The 3/4" diameter has an overall length of 1-7/16" and a hole size of 5/16"
- All three sizes have a 3/4" dowel receiving depth when fully inserted
- Natural translucent polypropylene material or black
- Other sizes and colors available – please inquire

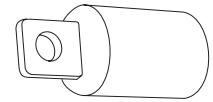

ITEM #	FOR USE WITH	COLOR
411230	3/8" dia. Wooden Banner Dowel Rods	Natural
411230B	3/8" dia. Wooden Banner Dowel Rods	Black
411231	1/2" dia. Wooden Banner Dowel Rods	Natural
411231B	1/2" dia. Wooden Banner Dowel Rods	Black
411232	3/4" dia. Wooden Banner Dowel Rods	Natural
411232B	3/4" dia. Wooden Banner Dowel Rods	Black

Wooden Banner Dowel Screw Eye

For use with our Wooden Banner Dowel Rods (sold separately). When properly inserted into pre-drilled ends of common wooden dowel rods, these inexpensive screw eyes/eyelets offer a sturdy hanging point. Works with many common hanging hardware options such as metal hooks or barbed cords.

Warning: Not recommended for use with barbed cords unless cord is tied directly to the screw eye.

- For an additional charge, screw eyes/eyelets can be factory inserted into our full line of wooden banner dowel rods – please inquire
- .080" wire diameter x 13/16" overall length with 5/32" closed eye I.D.
- Other sizes and colors/finishes available – please inquire
- Steel with bright zinc plate

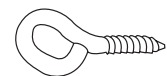

ITEM #	OVERALL LENGTH	FOR USE WITH
411240	13/16"	Wooden Banner Dowel Rods

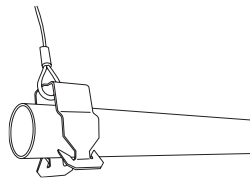

Metal Vinyl Graphic Banner Rod System

A quick and inexpensive way to suspend signs and displays horizontally from exposed solid or split beam open style warehouse ceilings. Can be combined with Pear Clips or Snap Rings (sold separately) to lock signs into place. Great for displaying sewn/hemmed fabric or vinyl banners. No tools required. Won't sag or warp like common wooden banner dowel rods. Each complete assembly requires one support tube and two or more cable assemblies – each sold separately. Each cable assembly includes our highly popular self-locking cable adjuster with a looped cable end assembly connected to a snap-on conduit hanging clip together in a convenient polybagged kit. **Warning:** Use only in dry, indoor locations with conduit hanging clips placed a minimum of 3/4" inward from each end of the support tube.

- Cable is 1/16" dia. (7x7) galvanized steel x 30 ft. long
- Conduit hanging clip is 3/4" wide x 1-5/8" long and is made of spring steel with zinc plate
- Round support tube is rigid 3/4" EMT conduit (.922" O.D.) x .049" wall thickness, painted white
- 10 ft. support tube requires an additional cable assembly hanging point located in the middle
- Other cable and support tube lengths and colors available – please inquire

ITEM #	OVERALL LENGTH	COMPONENT TYPE	NUMBER OF CABLE ASSEMBLIES REQUIRED	FINISH	SAFE WORKING LOAD LIMIT
220191	4 ft.	Support Tube	2	White	16 lbs.
220193	6 ft.	Support Tube	2	White	16 lbs.
220197	10 ft.	Support Tube	3	White	16 lbs.
105130	30 ft.	Cable Assembly	n/a	Zinc	16 lbs.

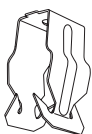

Conduit Support Tube Hanging Clip

For use in conjunction with our line of round Conduit Support Tubes (sold separately). Ingenious push-on type hanging clip that simply and securely snaps directly onto common 3/4" (.922" O.D.) rigid EMT conduit without the need for any additional hardware such as nuts or bolts. Integrated sharp jagged teeth hold firm and resist removal when fully engaged on painted or plain steel conduit. Center hole on top is great for attaching metal hooks, locking rings, chain or cable. **Warning:** Use only in dry, indoor locations with clips placed a minimum of 3/4" inward from each end of the support tube. Removable and reusable.

- No tools required
- 3/4" wide x 1-5/8" long with 9/32" diameter centered top hole
- Also available in black or other colors – please inquire
- .027" thick zinc plated spring steel
- Packaged 100 per bag

ITEM #	OVERALL LENGTH	FOR USE WITH
411205	1-5/8"	Conduit Support Tubes

Spiral Sign Board

Extruded panel holds both promotional signs and pricing simultaneously and cost effectively. When combined with our spiral sign board brackets and pads (both sold separately), these double-sided rigid boards are ideal for gondola tops, end caps and other in-store areas with changing price points. Display numerical and/or reading pads plus message graphics from one or both sides. Also can be hung from walls, windows or ceilings via integrated holes.

- #108839 holds 7-7/8" to 8" height signs in top channel (up to 1/8" thick) and 11-1/8" height spiral sign pads in bottom channel, with two 3/8" diameter mounting/hanging holes
- #109506B holds 4-1/2" height spiral sign pads in top channel (up to 5/32" thick) and 8" height spiral sign pads in bottom channel, with two 5/16" diameter mounting/hanging holes
- High impact polystyrene (HIPS) material
- One-sided boards, other lengths or colors also available – please inquire
- Packaged 10 per box

ITEM #	OVERALL LENGTH	OVERALL HEIGHT	FOR SPIRAL SIGN PADS	COLOR
108839	34"	20-3/8"	11-1/8" Tall	White
109506B	21"	15-3/8"	4-1/2" and 8" Tall	Black

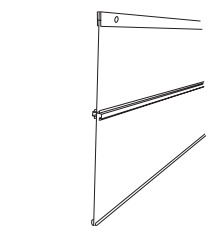

Spiral Sign Board Pads sold separately (see page 92)



Spiral Sign Board Brackets sold separately (see page 92)

Universal Three-Sided Mobile Kit

Our most economical three-way mobile kit. Plastic three-sided formers and all components needed to both support and hang graphic posters. An inexpensive way to turn advertising posters into eye-catching displays. Easy assembly.

Poster hole info: Hole sizes should be 1/4" diameter to accommodate former pop thru tips. Two centered holes are required per poster. All posters must be the same size for proper balance.

Universal mobile info: Top and bottom plastic formers secure three posters from 9" to 40" wide. Holes should be spaced a minimum of 3/4" from both the top and bottom edges of the poster.

- Formers are 4-1/2" wide x 1/2" thick, three sided
- Each former also has an integrated small loop for optional bottom dangler attachment
- Panel edge clips are 2" long
- Formers are natural polypropylene material
- Panel edge clips are clear PVC material
- Each polybagged kit contains one 6 ft. white Ceiling Hook & Cord, two formers, three panel edge clips, six pieces of two-sided white foam tape and assembly instructions

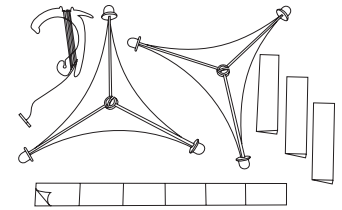

ITEM #	POSTER WIDTH
109543	9" to 40"

Triway Mobile Kit

Plastic triangular formers support and hang graphic posters. Can also accommodate display poles (1" to 1-1/2" O.D.) and turning motors by simply removing the center disk in the bottom former. An inexpensive way to turn advertising posters into eye catching, three sided, mobile or pole topped displays. Easy assembly.

Poster hole info: Hole sizes should be 7/32" diameter to accommodate former pop thru tips. Four holes are required per poster. All posters must be the same size for proper balance.

Small triway: Top and bottom plastic formers secure three posters from 10" to 24" wide. The top and bottom pair of holes should be 3-3/16" to each side of the center of the poster.

Large triway: Top and bottom plastic formers secure three posters from 20" to 40" wide. The top and bottom pair of holes should be 6-5/16" to each side of the center of the poster.

- Small formers are 6-3/8" wide x 5/16" thick, three sided
- Large formers are 12-5/8" wide x 1/2" thick, three sided
- Formers are natural polypropylene material
- Each polybagged kit contains one 6 ft. white ceiling attachment & cord, two formers and assembly instructions

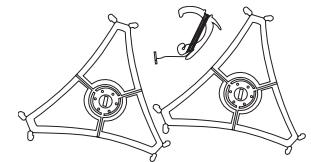

ITEM #	SIZE	POSTER WIDTH	CEILING ATTACHMENT
107060	Small	10" to 24"	Ceiling Hook & Cord
107061	Large	20" to 40"	Ceiling Hook & Cord
NEW 109661	Large	20" to 40"	Ceiling Twist Clip & Cord

Quadway Mobile Kit

Plastic four-sided formers that support and hang graphic posters. An inexpensive way to turn advertising posters into eye-catching, four-sided mobile or pole-top displays. Can also accommodate display poles 1" or 1-1/2" O.D. (sold separately) and turning motors by simply removing the center disk in the bottom former. Easy assembly.

Poster hole info: Hole sizes should be 1/4" diameter to accommodate former pop thru tips. Four holes are required per poster. All posters must be the same size for proper balance.

Quadway info: Top and bottom plastic formers secure four posters from 12" to 24" wide. The top and bottom pair of holes should be 3-1/4" to each side of the center of the poster.

- Formers are 11-1/2" wide x 5/16" thick, four sided
- Formers are natural polypropylene material
- Each polybagged kit contains one 6 ft. white Ceiling Hook & Cord, two formers and assembly instructions

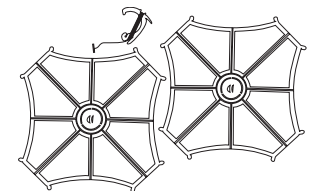

ITEM #	POSTER WIDTH
107065	12" to 24"



Wire Mobile Hanger & Cord

Versatile metal hook that installs easily on, or over, a variety of exposed ceiling supports or grids. Unravel wound barbed cord to desired length. Use to suspend lightweight signs, mobiles and banners.

- Hook opening is 1-1/4" wide and can negotiate over most metal ceiling grids
- Hook is .062" wire diameter x 5-1/4" overall length, bright galvanized spring steel
- Clear monofilament cord with zinc plated barbed end
- Packaged 25 per bag



ITEM #	CORD LENGTH	CORD COLOR
108040	5 ft.	Clear



Brass Wire Mobile Hanger & Cord

Versatile brass wire hook that installs easily on a variety of exposed ceiling supports or on the edge of common ceiling grids. Unravel wound barbed cord to desired length. Use to suspend lightweight signs, mobiles and banners. Solid brass wire material will not rust and can easily be bent as required.

- Hook opening is 5/8" wide and can be bent if desired
- Hook is .046" wire diameter x 4-5/8" overall length, solid brass material
- Clear monofilament cord with zinc plated barbed end
- Packaged 25 per bag



ITEM #	CORD LENGTH	CORD COLOR
108041	4 ft.	Clear
108042	6 ft.	Clear

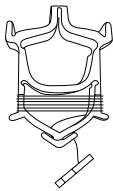

Snap-Lock Ceiling Clip & Cord

Plastic clip that hinges and locks securely onto most standard ceiling grids with a claw-like feature. Unravel the wound barbed cord to desired length. Use to suspend lightweight signs, mobiles and banners. Compatible with most installation/extension poles, including our red end poles (page 264).

- Clip is 1/2" wide and extends 1-1/2" from ceiling grid
- Twists off for easy removal
- Clip is white polypropylene
- Packaged 200 per bag



Installation Poles sold separately (see page 264)

ITEM #	CORD LENGTH	CORD COLOR	CORD MATERIAL
107084	4 ft.	White	Braided Polyester
107084C	4 ft.	Clear	Monofilament
107086	6 ft.	White	Braided Polyester
107086C	6 ft.	Clear	Monofilament
107088	8 ft.	White	Braided Polyester
107088C	8 ft.	Clear	Monofilament



Metal Squeeze Clip & Cord

Locks onto ceiling grid with a simple squeeze. Unwind barbed cord to desired length. Use to suspend lightweight signs, mobiles and banners.

- Clip is .062" wire diameter x 3-1/2" overall length, bright galvanized spring steel
- Cord is braided polyester material
- Packaged 100 per bag



ITEM #	CORD LENGTH	CORD COLOR
107056	6 ft.	White
107056B	6 ft.	Black

Ceiling Twist Clip & Cord

Plastic clip attaches to ceiling grid with a simple turn and lock feature. Unravel wound barbed cord to desired length. Use to suspend lightweight signs, mobiles and banners. Built-in slits allow for micro adjustments of cord length for even hanging. Compatible with most installation/extension poles, including our red end poles (see page 264).

- Clip is 2" long x 1/2" wide
- Clip is white polypropylene material
- Packaged 100 per bag

ITEM #	CORD LENGTH	CORD COLOR	CORD MATERIAL
107034	4 ft.	White	Braided Polyester
107034C	4 ft.	Clear	Monofilament
107036	6 ft.	White	Braided Polyester
107036C	6 ft.	Clear	Monofilament
107038	8 ft.	White	Braided Polyester
107038C	8 ft.	Clear	Monofilament

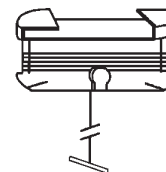

Installation Poles sold separately (see page 264)

Ceiling Hook & Cord

Versatile plastic hook installs easily on a variety of exposed ceiling supports or grids. Unravel wound barbed cord to desired length. Use to suspend lightweight signs, mobiles and banners. Compatible with most installation/extension poles, including our red end poles (see page 264).

- Hook is 2-1/4" long
- Hook is white polypropylene material
- Packaged 100 per bag

ITEM #	CORD LENGTH	CORD COLOR	CORD MATERIAL
107044	4 ft.	White	Braided Polyester
107044B	4 ft.	Black	Braided Polyester
107044C	4 ft.	Clear	Monofilament
107046	6 ft.	White	Braided Polyester
107046B	6 ft.	Black	Braided Polyester
107046C	6 ft.	Clear	Monofilament
107048	8 ft.	White	Braided Polyester
107048B	8 ft.	Black	Braided Polyester
107048C	8 ft.	Clear	Monofilament

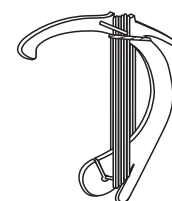

Installation Poles sold separately (see page 264)

Branched Multi-Cord Ceiling Clips

Twist-on style clip attaches to ceiling grid with a simple turn and lock feature. Versatile plastic hook installs easily on a variety of exposed ceiling supports or grids. Unravel wound barbed cord to desired length. Use to suspend three-paneled or four-paneled lightweight signs, mobiles and banners. Compatible with most installation/extension poles, including our red end poles (see page 264).

- Two ceiling grid attachment styles available
- Both twist-on clip & hook are white polypropylene material
- Cord is white braided polyester material
- 6 ft. long cord consists of one 4 ft. cord plus multiple 2 ft. long barbed branches
- Packaged 100 per bag

ITEM #	STYLE	OVERALL CORD LENGTH	NUMBER OF BRANCHES
107053	Twist-On Clip	6 ft.	3
107054	Twist-On Clip	6 ft.	4
107063	Hook	6 ft.	3
107064	Hook	6 ft.	4



Twist-On



Hook

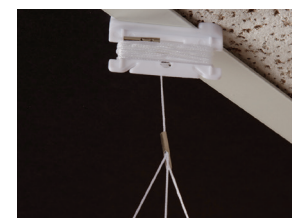

Installation Poles sold separately (see page 264)

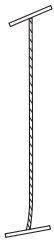

Barbed Cords

Use in conjunction with a Plastic Grid Clip With Hole (see page 259) or Hanging Coil (see page 263) to economically suspend lightweight signs. Recommended panel hole size is 1/8" to 3/16" diameter.

- White & black cords are tangle resistant
- Clear mono cord is nearly invisible
- .094" dia. x 5/8" long zinc plated steel barbs on both ends
- Length is measured between the barbs
- Other lengths and custom ends also available
- Packaged 100 per bundle



ITEM #	LENGTH	CORD COLOR	CORD MATERIAL
109001	1"	White	Braided 10/5 Polyester
109001B	1"	Black	Braided 10/5 Polyester
109001C	1"	Clear	.020" dia. Monofilament
109002	2"	White	Braided 10/5 Polyester
109002B	2"	Black	Braided 10/5 Polyester
109002C	2"	Clear	.020" dia. Monofilament
109003	3"	White	Braided 10/5 Polyester
109003B	3"	Black	Braided 10/5 Polyester
109003C	3"	Clear	.020" dia. Monofilament
109004	4"	White	Braided 10/5 Polyester
109004B	4"	Black	Braided 10/5 Polyester
109004C	4"	Clear	.020" dia. Monofilament
109006	6"	White	Braided 10/5 Polyester
109006B	6"	Black	Braided 10/5 Polyester
109006C	6"	Clear	.020" dia. Monofilament
109008	8"	White	Braided 10/5 Polyester
109008B	8"	Black	Braided 10/5 Polyester
109008C	8"	Clear	.020" dia. Monofilament
109010	10"	White	Braided 10/5 Polyester
109010B	10"	Black	Braided 10/5 Polyester
109010C	10"	Clear	.020" dia. Monofilament
109012	12"	White	Braided 10/5 Polyester
109012B	12"	Black	Braided 10/5 Polyester
109012C	12"	Clear	.020" dia. Monofilament
109018	18"	White	Braided 10/5 Polyester
109018B	18"	Black	Braided 10/5 Polyester
109018C	18"	Clear	.020" dia. Monofilament
109024	24"	White	Braided 10/5 Polyester
109024B	24"	Black	Braided 10/5 Polyester
109024C	24"	Clear	.020" dia. Monofilament
109036	36"	White	Braided 10/5 Polyester
109036B	36"	Black	Braided 10/5 Polyester
109036C	36"	Clear	.020" dia. Monofilament

Elastic Barbed Cords

Stretches to approximately twice its length. Use to hold and suspend lightweight signs. Recommended panel hole size is 1/8" to 3/16" diameter.

- Length is measured between the barbs
- Other lengths, custom ends and colors also available
- Elastic rubber inner cord wrapped in durable .060" dia. white or black polyester
- .109" dia. x 11/16" long zinc plated steel barbs on both ends
- Packaged 100 per bundle

ITEM #	RESTED LENGTH	APPROX. STRETCHED LENGTH	CORD COLOR
109051	1"	2"	White
109051B	1"	2"	Black
109052	2"	4"	White
109052B	2"	4"	Black
109053	3"	6"	White
109053B	3"	6"	Black
109054	4"	8"	White
109054B	4"	8"	Black
109056	6"	12"	White
109056B	6"	12"	Black
109058	8"	16"	White
109058B	8"	16"	Black
109060	10"	20"	White
109060B	10"	20"	Black
109062	12"	24"	White
109062B	12"	24"	Black
109068	18"	36"	White
109068B	18"	36"	Black



Mobile Springs

Economical sign suspension solution that is both adjustable and tangle-free. Hang lightweight signs and mobiles fast, straight and level with ease. Spiral wire with hook ends. Pulls out to a variety of lengths, from 6 inch up to 8 feet, and stays put; thus yielding exact sign heights, as desired. Low carbon steel hook ends can be hand-bent to hook directly onto the edge of most common ceiling grids. Also known as Stretchies or Jet Wires.

- 6" long part is .060" O.D. spiral wire
- 8" and 12" long parts are .075" O.D. spiral wire
- 3/8" hook openings on both ends
- Not a spring: will not return to original length once stretched
- Galvanized steel wire material
- Sold in full bags only

ITEM #	RESTED LENGTH	MAX. STRETCHED LENGTH	PACKAGED
108030	6 in.	4 ft.	100 per bag
108031	8 in.	5 ft.	100 per bag
108032	12 in.	8 ft.	25 per bag



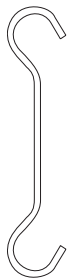

Double “C” Hooks

Economical fixed length hooks hang signs level. Also known as Hangwires.

- 5/8" hook opening
- .093" wire diameter, bright galvanized steel
- Packaged 50 per bundle



ITEM #	OVERALL LENGTH
108010	4"
108011	6"
108012	8"
108013	10"
108014	12"
108015	16"
108016	18"
108017	20"
108018	24"
108020	30"
108021	36"
108022	40"
108023	48"



Plastic Double “C” Hooks – Open Ends

Fixed length clear plastic, open end hooks that hang signs level. Clear color is not as noticeable as common wire hooks.

- 5/32" diameter
- 3/8" hook opening on both ends
- Minimum recommended panel hole size is 13/64"
- Polycarbonate material
- Packaged 50 per bundle



ITEM #	OVERALL LENGTH	COLOR
220204	4"	Clear
220206	6"	Clear
220208	8"	Clear
220212	12"	Clear
220216	16"	Clear

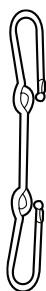

Plastic Double “C” Hooks – Locking Ends

Fixed length clear plastic, teardrop shaped, locking loop ends that hang signs level. A safer alternative to clear plastic or metal open end Double “C” Hooks. Removable and reusable. Clear color is not as noticeable as common wire hooks. Also known as Safety Hooks.

- 5/32" diameter
- 1-1/4" length x 7/16" width locked loops on both ends
- Can be linked together for multiple lengths
- Minimum recommended panel hole size is 13/64"
- Polycarbonate material
- Packaged 50 per bundle



ITEM #	OVERALL LENGTH	COLOR
220306	6"	Clear
220312	12"	Clear
220318	18"	Clear

“S” Hooks

Nice range of common lengths and diameters for various hanging applications.

- Steel material, stocked in the finishes listed below

ITEM #	WIRE DIAMETER	LENGTH	FINISH
108003	.080"	1"	Bright Galvanized
108003B	.080"	1"	Black Oxide
108004	.093"	7/8"	Bright Galvanized
108005	.120"	1-5/16"	Bright Galvanized
108006	.135"	1-5/8"	Bright Galvanized
108007	.148"	2"	Bright Galvanized
108008	.177"	2-7/8"	Bright Galvanized



“C” Links

Economical way to hang multiple signs evenly and straight, one below the other.

- .093" wire diameter, bright galvanized steel
- Packaged 100 per bag

ITEM #	OVERALL LENGTH	OPENING
108001	1-1/2"	15/32"
108002	3"	5/8"



Wire Snap Link

Economical spring lock design that snaps easily and locks securely. Popular for directly connecting chain or the ends of cable to grid ceiling loops or banner hanger clips. Extremely strong for its thin wire design. Stainless steel offers corrosion resistance. Clips totally shut for a secure closure. **Warning:** Light duty use only – not designed for lifting.

- 1/32" wire diameter
- 1-1/4" overall length
- 11/16" closed inside loop length
- Other sizes available – please inquire
- Stainless steel material

ITEM #	LENGTH
101074	1-1/4"



“U” Hook

In conjunction with Binder Post & Screws (up to 3/4" long), “U” Hooks are popular for use on foam board and other thick sign material. Also used to attach two sign panels back to back, or for holding sample swatches. Binder Post & Screws are sold separately.

- 2" overall length x 3/4" wide
- 1/4" I.D. looped ends
- .093" wire diameter, bright galvanized steel
- Packaged 100 per bag

ITEM #	LENGTH	MAX. MATERIAL THICKNESS
106002	2"	3/4"



Binder Post & Screw
sold separately
(see page 226-230)

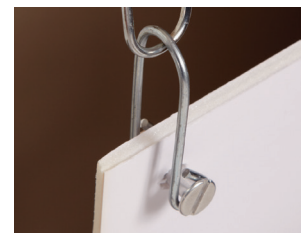
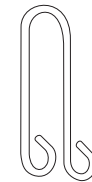

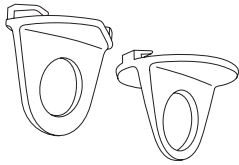

Ceiling Twist Loop

Securely attach to ceiling grid with a simple turn and lock feature. Compatible with most installation/extension poles, including our red end poles (see page 264). Can serve as a permanent fixture or can be easily removed for repositioning.

- 7/8" diameter loop



Installation Poles sold separately (see page 264)

ITEM #	BASE SHAPE	BASE DIMENSIONS	COLOR	MATERIAL
107010	Round	2" O.D.	White	Styrene
107015	Rectangular	2" Long x 1-1/4" Wide	White	Styrene
107015C	Rectangular	2" Long x 1-1/4" Wide	Clear	Polycarbonate

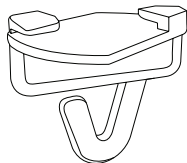

Ceiling Twist Hook

Securely attach to ceiling grid with a simple turn and lock feature. Can serve as a permanent fixture or can be easily removed for repositioning. Compatible with most installation/extension poles, including our red end poles (see page 264).

- 1/8" hook opening
- 1-1/2" overall length
- Styrene material



Installation Poles sold separately (see page 264)

ITEM #	BASE SHAPE	BASE DIMENSIONS	COLOR
107017	Rectangular	2" Long x 1-1/4" Wide	White
107017C	Rectangular	2" Long x 1-1/4" Wide	Clear

Swivel Ceiling Grid Clip

Rotate a sign to just the right viewing angle with a twist of the integrated loop. Securely attach to ceiling grid with a simple turn and lock feature. Can serve as a permanent fixture or can be easily removed for repositioning. Closed loop size is great for use with plastic and wire hooks (sold separately). Also known as Spider Clips.

- 3-1/4" long x 1-1/8" wide
- Extends 7/8" from ceiling grid
- Loop rotates 360 degrees
- Polycarbonate material
- Packaged 100 per bag

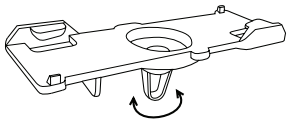

ITEM #	LENGTH	COLOR
107018	3-1/4"	Clear

Aluminum Ceiling Hook

Interlocking two piece metal hook is reusable and extremely sturdy. Easy “slide on” ceiling grid installation. Each complete assembly (either hook or ring) requires two pieces. Simply slide one interlocking left and right together to form a hook, or two lefts/two rights to form a ring.

- 1" wide x 1-1/2" long
- 1/4" hook opening
- .040" thick aluminum, painted white

ITEM #	SIDE
107026	Left
107027	Right

Reminder: Complete assembly requires two pieces (either one left & one right, or two of the same), which are sold separately

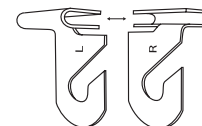

One left and one right



Two of the same

One-Piece Folding Aluminum Ceiling Hook

Avoid the step of engaging traditional interlocking two-piece aluminum ceiling hooks together. This single piece, folding style ceiling grid hook is quick, secure and extremely sturdy. Easy “fold-onto-grid” installation that is great for ceiling displays requiring cord, hooks, chain or cable.

- Can serve as a permanent fixture
- 1" wide x 1-1/2" long
- 3/16" hook opening
- .040" thick aluminum, painted white
- Packaged 100 per bag

ITEM #	WIDTH	COLOR
107163	1"	White



Clear Hinged Ceiling Hook

One piece clear plastic hook hinges open and closes around ceiling grid. Easy on & easy off. Clear color is unnoticeable. Removable & reusable.

- 3/4" wide x 1-3/8" long
- 21/64" hook opening
- Transparent lexan material
- Packaged 100 per bag

ITEM #	COLOR
107025	Clear

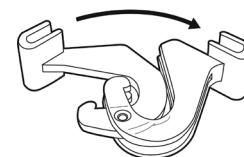

Plastic Grid Clip With Hole

Plastic clip grabs ceiling grid for tight and secure attachment. An alternative to wire clips and safer than open hooks. Small hole makes it great for use with Barbed Cords (sold separately – see page 254).

- 3/4" length x 5/8" width
- Polypropylene material
- Packaged 250 per bag

ITEM #	HOLE DIAMETER	COLOR
107019	5/32"	Clear
107020	5/32"	White

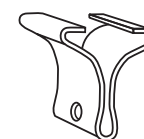

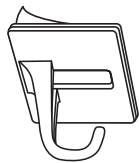

“J” Hook With Adhesive

Simply peel and stick for a secure hold on ceiling grids or any other clean, flat surface. Hook opening makes it great for lightweight rings and hooks.

- Hang horizontally or vertically
- Base has adhesive backing
- 7/8" overall height
- White styrene material
- Packaged 8 pieces per sheet



ITEM #	BASE DIMENSIONS	HOOK OPENING
107028	1" x 1"	11/32"

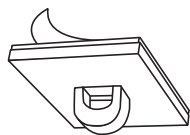

Adhesive Ceiling Loop

Simply peel and stick for a secure hold on ceiling grids or any other clean, flat surface. Small hole (loop) makes it great for attaching barbed cords, tags and lightweight hooks.

- Base has adhesive backing
- .328" overall height
- White polypropylene material
- Packaged 250 per bag



ITEM #	BASE DIMENSIONS	LOOP DIAMETER
107023	3/4" x 3/4"	3/16"

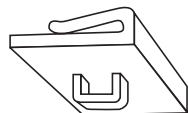

Clip-On Ceiling Loop

Also known as a “Mini-Clipper,” this clip connects securely to one side of ceiling grid. Also fits well on the lip of perimeter ceiling grid for hanging signs and banners flush to the wall. Small hole (loop) makes it great for attaching barbed cords, hooks and locking rings.

- 1/2" leg length
- .469" overall height
- White polypropylene material
- Packaged 250 per bag



ITEM #	BASE DIMENSIONS	LOOP DIAMETER
107024	3/4" x 3/4"	3/16"

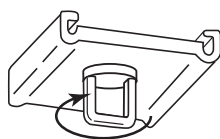

Ceiling Swivel Loop Clip

Rotate a sign to just the right viewing angle with a simple rotation of the loop. Plastic clip grabs the ceiling grid for a secure attachment. Small loop size is great for use with wire hooks and barbed cords.

- Snaps onto standard 15/16" ceiling grid tee bars
- Loop rotates 360 degrees
- White styrene material
- Packaged 250 per bag



ITEM #	BASE DIMENSIONS	LOOP I.D.
107029	1" x 3/4"	.156"

Magnetic Hooks

Display lightweight signs and products from metal surfaces. Magnets are easily placed and removed. Attaches well to most ferrous metal surfaces. **Warning:** Holding capacity is the approximate maximum pull rating under ideal conditions. Always test suitability on a per application basis. For best results, use on an indoor, bare (unfinished) metal surface that is smooth and clean. Metal conditions will affect holding power. Magnets should not be used near electronic equipment.

- All three sizes offered are 1-1/4" overall length
- Round magnet base with round metal housing with hook attachment

ITEM #	BASE O.D.	HORIZONTAL CAPACITY	HOOK OPENING	FINISH
107030	1"	9 lbs.	.187"	Powder Coated White
107031	1-1/4"	14 lbs.	.187"	Powder Coated White
107032	2"	20 lbs.	.312"	Chrome Plated



Open hook can be pinched closed to form an eye (please inquire).

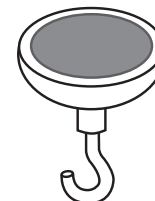

Heavy Duty Magnetic Hook

Display signs and products from metal surfaces. Attaches to most ferrous metal surfaces and is extremely strong. Otherwise known as a Gorilla 2-5/8" Animal Magnet. **Warning:** Holding capacity is the approximate maximum pull rating under ideal conditions. Always test suitability on a per application basis. For best results, use on an indoor, bare (unfinished) metal surface that is smooth and clean. Metal conditions will affect holding power.

- 1-1/2" overall length
- Free spinning, 9/16" x 5/16" x 1-7/8" long natural nylon block
- Can serve as a permanent fixture or can be removed and repositioned
- Round magnetic base with white painted metal housing with hook attachment

ITEM #	BASE O.D.	HORIZONTAL CAPACITY	HOOK OPENING	FINISH
107045	2-1/4"	45 lbs.	.172"	Powder Coated White

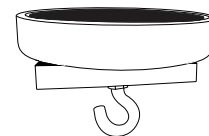

Extra Heavy-Duty Magnetic Hook

Our strongest magnetic hook, yet economical. Display signs and products from metal surfaces. Extremely strong for its 2" diameter size. Attaches to most ferrous metal surfaces. **Warning:** Holding capacity is the approximate maximum pull rating under ideal conditions. Always test suitability on a per application basis. For best results, use on an indoor, bare (unfinished) metal surface that is smooth and clean. Metal conditions will affect holding power.

- 1-13/32" overall length
- Can serve as a permanent fixture or can be removed & repositioned
- Round magnetic base with chrome plated housing with hook attachment

ITEM #	BASE O.D.	HORIZONTAL CAPACITY	HOOK OPENING	FINISH
109510	2"	50 lbs.	.250"	Chrome Plated

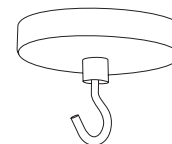
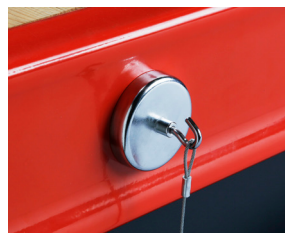

Magnetic Ceiling Loop

Specifically designed for use on metal ceiling grids as an alternative to wire clips and open magnetic hooks. Rectangular metal casing containing an integrated flex rubber magnetic base. Both sizes have a closed loop that can securely hold hooks, cable or chain. Removable and reusable. **Warning:** Holding capacity is the approximate maximum pull rating under ideal conditions. Always test suitability on a per-application basis. For best results, use on an indoor, bare (unfinished) metal surface that is smooth and clean. Metal conditions will affect holding power. Magnets should not be used near electronic equipment.

- For use on standard 15/16" metal ceiling grid tee bars
- 1" long part is 7/8" wide x 1/4" height (not including loop)
- 2" long part is 1" wide x 5/16" height (not including loop)
- .120" inside loop height - centered
- Nickel plated steel housing

ITEM #	LENGTH	HORIZONTAL CAPACITY
107039	1"	5 lbs.
107035	2"	14 lbs.

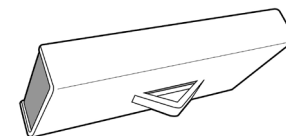

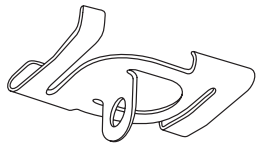

Metal Ceiling Twist Loop

Superior grip. Super strong spring steel. Twist on to lock securely on ceiling grid. When locked in place, this is our strongest ceiling clip. No special tools required.

- For use on standard 15/16" ceiling grid tee bars
- 20 gauge spring steel, painted white
- Packaged 100 per bag

ITEM #	BASE LENGTH	BASE WIDTH	LOOP I.D.
107021	1-1/2"	1"	15/64"

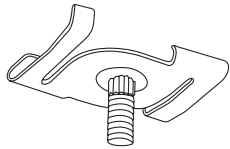

Metal Ceiling Twist Stud

Superior grip. Super strong spring steel. Twist on to lock securely on ceiling grid. Stud allows for attachment to a variety of signs and fixtures. No special tools required. Longer stud lengths also available.

- For use on standard 15/16" ceiling grid tee bars
- Base is 20 gauge spring steel painted white
- Fully threaded stud is zinc plated steel
- Packaged 100 per bag

ITEM #	BASE LENGTH	BASE WIDTH	STUD DIMENSIONS
107022	1-1/2"	1"	1/4-20 x 5/8"

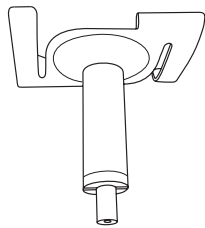

Ceiling Twist Side Exit Cable Adjuster

Suspend lighting, signs and other fixtures directly to common drop-ceiling style grids in a vertical fashion. Twist-on-to-lock ceiling grid attachment design that quickly and easily allows for adjustment of bare cable (sold separately). Adjusters have a unique ball bearing push-button feature with integrated side exit for easy height adjustments. Holes on the top side and underside allow bare cable to pass through. **Warning:** Use only on bare cable (wire rope). Do not use on painted or coated cable. Not recommended for suspension of objects at angles.

- For use on standard 15/16" ceiling grid tee bars
- Turn and lock base is 1-1/2" long x 1" wide with 20 gauge steel painted white
- Cable adjuster body is 1" long x .354" diameter
- Cable passes through the bottom and exits out the side
- No special tools or setting keys required
- Reliable built-in 5 to 1 safety factor
- Nickel plated brass and steel material
- Packaged 100 per bag

ITEM #	FOR USE WITH BARE CABLE DIA.	SAFE WORKING LOAD LIMIT *
105160	1/32" (3x7)	7 lbs. (when used with 1/32" cable)
	or 1/16" (7x7)	or 30 lbs. (when used with 1/16" cable)

* Rating is for cable adjuster only, not for the ceiling grid. Consult ceiling grid weight specifications.

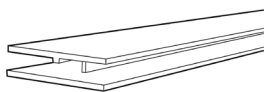

Grid Ceiling Spanner Bar

Allow for pinpoint positioning of signage at any location on the ceiling without being limited to the location of existing ceiling grids. No tools required. Simply rotate ends in place over existing ceiling grid edges – notched ends allow for a secure overlap. Also known as Cross Beams and Tile Dividers.

- Compatible with most grid ceilings
- Works in conjunction with all types of metal and plastic ceiling clips & hooks (sold separately)
- .048" thick aluminum, painted white

ITEM #	LENGTH	WIDTH
104100	24"	1"

“V” Clip

Most economical way to attach to a grid ceiling. Very strong for its small size.

- Galvanized spring steel
- Packaged 500 per bag

ITEM #	WIRE DIAMETER	LENGTH
107001	.047"	1"



Swivel Snail Disk With Adhesive

Simply peel and stick for a secure hold on smooth plaster or other solid flat ceiling surfaces. Integrated metal loop rotates so signs can be hung at perfect viewing angles.

- 1-1/4" overall length
- Hang horizontally or vertically
- Round base has adhesive backing
- Loop is steel with zinc plate
- Base is white polypropylene material
- Packaged 100 per bag

ITEM #	BASE O.D.	LOOP WIDTH
107014	1-1/2"	11/32"

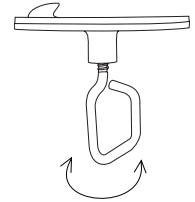

Hanging Coil

Both sizes screw into any location on an acoustic tile ceiling, with the 3/8" O.D. being the most popular. Also used on foam board (a.k.a. Gator Board) edges. Small loop makes it great for use with Barbed Cords (sold separately – see page 254).

- Galvanized spring steel
- Packaged 100 per bag

ITEM #	WIRE DIAMETER	O.D.	LENGTH
106005	.035"	1/4"	1"
106001	.040"	3/8"	1-1/4"



Squeeze Clip

Our most popular ceiling grid clip. Locks onto ceiling grid with a simple squeeze.

- Bright galvanized spring steel
- Packaged 100 per bag

ITEM #	WIRE DIAMETER	LENGTH
107003	.062"	3"

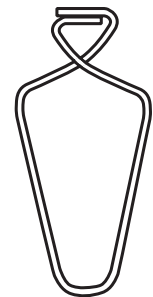
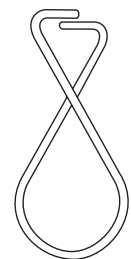

Figure “8” Squeeze Clip

Locks securely on ceiling grid with a squeeze.

- Bright galvanized spring steel
- Packaged 100 per bag

ITEM #	WIRE DIAMETER	LENGTH
107004	.062"	2-1/2"



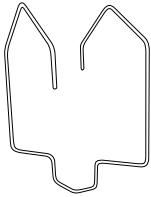

Warehouse Ceiling Hook For Solid Beam

Use to hang banners from exposed solid beams. Works great with cable and chain (sold separately). Compatible with most installation/extension poles, including our red end poles (see below).

- 6" wide x 8" tall
- 11-gauge (.121" diameter) wire
- Holds up to 7 lbs. when hung properly
- Zinc plated steel material

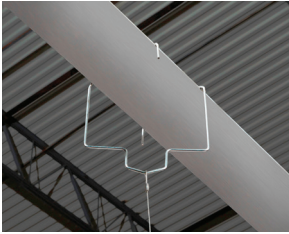

ITEM #	WIDTH	HEIGHT	FOR USE ON
107009	6"	8"	Solid Beams

Installation
Poles sold
separately
(see below)

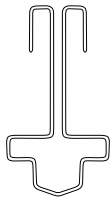

Warehouse Ceiling Hook For Split Beam

Use to hang banners from exposed split beams. Works great with cable and chain (sold separately). Compatible with most installation/extension poles, including our red end poles (see below).

- 4-1/4" wide x 7-1/4" tall
- 11-gauge (.121" diameter) wire
- Holds up to 7 lbs. when hung properly
- Zinc plated steel material



ITEM #	WIDTH	HEIGHT	FOR USE ON
107008	4-1/4"	7-1/4"	Split Beams

Installation
Poles sold
separately
(see below)

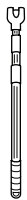

Installation Poles

Hang or remove signs, banners and ceiling accessories from ground level without the need for a ladder – quick and safe! Smooth telescopic pole for use with a wide variety of our plastic and metal sign hanging components (sold separately). Otherwise known as Lifter or Extension Poles.

- Permanently affixed 2" inside width red plastic socket end
- Clear satin anodized finish with black hand grip
- Reliable twist-lock features
- Lightweight aluminum material



ITEM #	EXTENDED LENGTH	FOR MAXIMUM CEILING HEIGHTS	COLLAPSED LENGTH	NUMBER OF SECTIONS
220025	10 ft.	15 ft.	47"	3
220027	18 ft.	23 ft.	65"	4

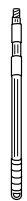

Threaded Extension Pole

Fixed single length economy style or smooth telescopic poles with standard acme threaded ends that are designed to fit multiple styles of common internally threaded end accessories such as squeegees, paint rollers or reaching mechanisms. Otherwise known as installation poles.

- Integrated 3/4" diameter reinforced acme threaded black plastic end tip x 1" long
- Clear satin anodized finish with black plastic hand grip end
- Telescopic styles offer reliable twist-lock features
- Lightweight aluminum material



ITEM #	EXTENDED LENGTH	COLLAPSED LENGTH	NUMBER OF SECTIONS
220004	4 ft.	48"	1
220010	10 ft.	47"	3
220018	18 ft.	65"	4



Cable & Chain



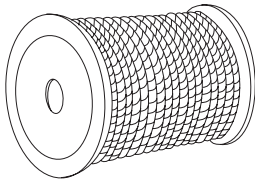

Steel Cable

Flexible galvanized aircraft quality cable (wire rope) is stronger and less expensive than chain. Also, cable is thinner and less noticeable than chain. The recommended safe working load is a 5 to 1 ratio (i.e. approximate break strength divided by 5).

- Both bare and coated cable available
- Packaged on single plastic spools at the lengths listed below
- Custom lengths available



ITEM #	WIRE DIAMETER	SPOOL LENGTH	MATERIAL	COATING	APPROX. BREAK STRENGTH	RECOMMENDED SAFE WORKING LOAD
103001	1/32" (3x7)	100 ft.	Galvanized Steel	Bare	110 lbs.	22 lbs.
103002	1/32" (3x7)	250 ft.	Galvanized Steel	Bare	110 lbs.	22 lbs.
103003	1/32" (3x7)	500 ft.	Galvanized Steel	Bare	110 lbs.	22 lbs.
103004	1/32" (3x7)	1,000 ft.	Galvanized Steel	Bare	110 lbs.	22 lbs.
103013	1/32" (3x7)	10,000 ft.	Galvanized Steel	Bare	110 lbs.	22 lbs.
103023	1/32" (7x7)	100 ft.	Stainless Steel	Nylon	90 lbs.	18 lbs.
103024	1/32" (7x7)	250 ft.	Stainless Steel	Nylon	90 lbs.	18 lbs.
103025	1/32" (7x7)	500 ft.	Stainless Steel	Nylon	90 lbs.	18 lbs.
103026	1/32" (7x7)	1,000 ft.	Stainless Steel	Nylon	90 lbs.	18 lbs.
103029	1/32" (7x7)	5,000 ft.	Stainless Steel	Nylon	90 lbs.	18 lbs.
103005	1/16" (7x7)	100 ft.	Galvanized Steel	Bare	480 lbs.	96 lbs.
103006	1/16" (7x7)	250 ft.	Galvanized Steel	Bare	480 lbs.	96 lbs.
103007	1/16" (7x7)	500 ft.	Galvanized Steel	Bare	480 lbs.	96 lbs.
103008	1/16" (7x7)	1,000 ft.	Galvanized Steel	Bare	480 lbs.	96 lbs.
103014	1/16" (7x7)	5,000 ft.	Galvanized Steel	Bare	480 lbs.	96 lbs.
103009	1/16" (7x7)	100 ft.	Galvanized Steel	Vinyl	270 lbs.	54 lbs.
103010	1/16" (7x7)	250 ft.	Galvanized Steel	Vinyl	270 lbs.	54 lbs.
103011	1/16" (7x7)	500 ft.	Galvanized Steel	Vinyl	270 lbs.	54 lbs.
103012	1/16" (7x7)	1,000 ft.	Galvanized Steel	Vinyl	270 lbs.	54 lbs.
103015	1/16" (7x7)	5,000 ft.	Galvanized Steel	Vinyl	270 lbs.	54 lbs.
103031	3/32" (7x7)	100 ft.	Galvanized Steel	Bare	920 lbs.	184 lbs.
103032	3/32" (7x7)	250 ft.	Galvanized Steel	Bare	920 lbs.	184 lbs.
103033	3/32" (7x7)	500 ft.	Galvanized Steel	Bare	920 lbs.	184 lbs.
103034	3/32" (7x7)	1,000 ft.	Galvanized Steel	Bare	920 lbs.	184 lbs.
103037	3/32" (7x7)	5,000 ft.	Galvanized Steel	Bare	920 lbs.	184 lbs.
103017	1/8" (7x7)	100 ft.	Galvanized Steel	Bare	1,700 lbs.	340 lbs.
103018	1/8" (7x7)	250 ft.	Galvanized Steel	Bare	1,700 lbs.	340 lbs.
103019	1/8" (7x7)	500 ft.	Galvanized Steel	Bare	1,700 lbs.	340 lbs.
103022	1/8" (7x7)	5,000 ft.	Galvanized Steel	Bare	1,700 lbs.	340 lbs.

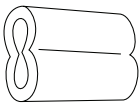

Cable Sleeves (Crimps)

Cable sleeves are used in conjunction with steel cable for looping and swaging ends. **Warning:** Swaging over vinyl or nylon coated cable will result in severely reduced holding power and is not recommended in applications where human safety, lifting or full wire strength is involved.

- Oval duplex design
- Cable sleeves are also known as Crimps or Ferrules



ITEM #	CABLE DIAMETER	MATERIAL
105001	1/32"	Zinc Plated Copper
105002	1/16"	Aluminum
105006	3/32"	Aluminum
105003	1/8"	Aluminum

Looped End Cable Assemblies

Flexible bare steel cable assemblies with factory installed, crimped-on fittings. Very strong and durable.

- Standard assemblies (those listed below) have cable-sleeved loops on both ends
- Custom lengths, cable diameters or loop configurations are also available
- Other cable endings include straight cuts (no fitting), button stops, eyelets and ball stops

ITEM #	CABLE DIAMETER	OVERALL LENGTH	LOOP LENGTH
102001	1/32"	6"	1/2"
102002	1/32"	12"	1/2"
102003	1/32"	18"	1/2"
102004	1/32"	24"	1/2"
102005	1/32"	36"	1/2"
102012	1/32"	48"	1/2"
102006	1/16"	6"	3/4"
102007	1/16"	12"	3/4"
102008	1/16"	18"	3/4"
102009	1/16"	24"	3/4"
102010	1/16"	36"	3/4"
102011	1/16"	48"	3/4"

Other popular cable end fittings available:



Eyelet



Ball stop



Button stop



Straight cut (no fitting)



Order your parts pre-assembled to save you time & money.

Fixed Style Cable End – Snap Hook

When properly swaged over 1/16" bare cable (sold separately), this fitting gives you a fixed snap hook at the end of your cable assembly. J-shaped, spring snap design offers multiple uses. Creates a quick and easy way to hang banners, displays, or even lighting and electrical fixtures. **Please note:** This fitting cannot be crimped with a hand swager tool. This must be factory installed (crimped) using a hydraulic press – please inquire with cable length(s) required. **Warning:** Not designed for lifting.

- 2-1/8" overall length
- When crimped onto cable, will extend cable assembly by approximately 1-1/2" per end
- .175" wire diameter
- 3/8" snap opening
- Zinc plated steel

ITEM #	FITS OVER	SAFE WORKING LOAD LIMIT
105113	1/16" (7x7) Bare Cable	25 lbs.

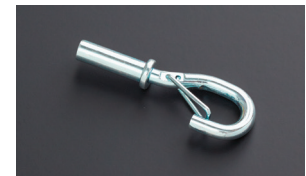

Have Kinter create your custom cable assembly for you. Just hang & go!

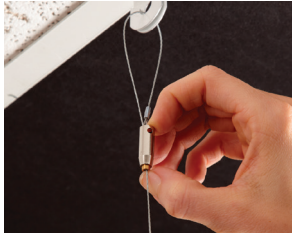

Bullet Style Cable Adjuster

Fast and easy way to form a loop with bare cable (sold separately) to suspend lightweight signs and fixtures vertically or at slight angles. "Bullet" shaped jacket contains an integrated wedge and spring that acts as both a cable release and a locking mechanism for easy height adjustments. **Warning:** Use only on bare cable (wire rope) in dry, indoor locations. Do not use on coated cable. Suspension of objects at angles reduces the safe working load limits (call for details).

- No special tools or setting keys required
- Reliable built-in 10 to 1 safety factor
- Nickel plated brass material
- Packaged 500 per bag

ITEM #	FOR USE WITH BARE CABLE DIA.	LENGTH	DIAMETER	SAFE WORKING LOAD LIMIT
105115	1/32" (3x7)	1"	5/16"	11 lbs.

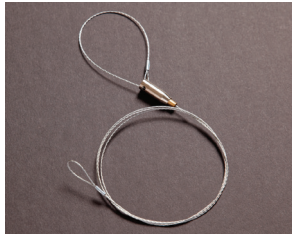
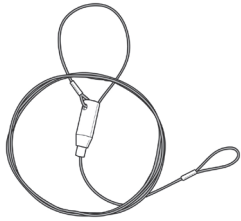

Bullet Style Cable & Adjuster Kits

Our economically priced self-locking "bullet" shaped cable adjuster with an attached looped end cable in a convenient kit. Easily raise or lower signs with no tools required. Adjustable hanging loop length of cable is a minimum of half its stated length and a maximum of its full stated length. 1/32" cable is great for lightweight applications. **Warning:** Use only in dry, indoor locations. Suspension of objects at angles reduces the safe working load limits (call for details).

- Cable is 1/32" dia. (3x7) galvanized steel
- Cable is permanently attached to adjuster on one end and has a 3/4" long loop & crimp on the other end
- Economy style cable adjuster that needs no special tool or setting key
- Cable with adjuster holds up to 11 lbs.
- Other cable lengths available upon request
- Each sealed, clear polybagged kit contains one adjuster and one cable, pre-assembled

ITEM #	CONTENTS	APPROX. LOOP LENGTH RANGE
105140	One Bullet Style Adjuster and One 5 ft. long Cable	2-1/2 ft. thru 5 ft.
105141	One Bullet Style Adjuster and One 10 ft. long Cable	5 ft. thru 10 ft.
105142	One Bullet Style Adjuster and One 20 ft. long Cable	10 ft. thru 20 ft.
105143	One Bullet Style Adjuster and One 30 ft. long Cable	15 ft. thru 30 ft.



Snap Hook Bottom Exit Cable Adjuster

Our least expensive snap hook cable lock. Quick and easy way to add an adjustable snap hook to bare cable (sold separately). Suspend lighting, signs and other fixtures vertically. Adjusters have a unique ball bearing push-button feature with bottom exit for easy height adjustments. Holes at top and bottom allow cable to traverse directly through. Lightweight, self-locking and reusable. **Warning:** Use only on bare cable (wire rope) in dry, low-humidity, indoor locations. Do not use on painted or coated cable. Suspension of objects at angles reduces the safe working load limits (call for details).

- 1-3/16" overall length with 13/64" snap opening
- Cable passes through the top and exits out the bottom
- No special tools or setting keys required
- Reliable built-in 5 to 1 safety factor
- Nickel plated zinc alloy and brass material
- Packaged 200 per bag

ITEM #	FOR USE WITH BARE CABLE DIA.	SAFE WORKING LOAD LIMIT
105159	1/32" (3x7)	7 lbs. (when used with 1/32" cable)
	or 1/16" (7x7)	or 30 lbs. (when used with 1/16" cable)



Threaded Side Exit Cable Adjuster

Choose between male (external) or female (internal) thread. Quick and easy way to add an adjustable threaded receiver fitting to bare cable (sold separately). Suspend lighting, signs and other fixtures vertically. Adjusters have a unique ball bearing push-button feature with integrated side exit for easy height adjustments. Lightweight, self-locking and reusable. Holes at top and on the side allow bare cable to pass through. **Warning:** Use only on bare cable (wire rope) in dry, low-humidity, indoor locations. Do not use on painted or coated cable. Suspension of objects at angles reduces the safe working load limits (call for details).

- Body is 1" long x .354" diameter
- Bottom of female adjuster has internally tapped 10-32 threading x 1/4" depth
- Bottom of male adjuster has 10-32 external threading x 5/16" long
- Cable passes through the top and exits out the side
- No special tools or setting keys required
- Reliable built-in 5 to 1 safety factor
- Nickel plated brass and/or steel material
- Packaged 200 per bag

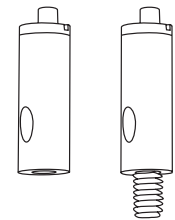

#105157 #105161



ITEM #	THREAD TYPE	FOR USE WITH BARE CABLE DIA.	SAFE WORKING LOAD LIMIT
105157	Female	1/32" (3x7) and 1/16" (7x7)	7 lbs. for 1/32" & 30 lbs. for 1/16"
105161	Male	1/32" (3x7) and 1/16" (7x7)	7 lbs. for 1/32" & 30 lbs. for 1/16"

Pigtail Hook Side Exit Cable Adjuster

Versatile "pigtail" shaped open hook design that quickly and easily adds an adjustable hook to bare cable (sold separately). Suspend lighting, signs and other fixtures vertically. Adjusters have a unique ball bearing push-button feature with integrated side exit for easy height adjustments. Lightweight, self-locking and reusable. Holes at top and on the side allow bare cable to pass through. **Warning:** Use only on bare cable (wire rope) in dry, low-humidity, indoor locations. Do not use on painted or coated cable. Suspension of objects at angles reduces the safe working load limit (call for details).

- Body is 1" long x .354" diameter
- Pigtail shaped hook end is .140" wire diameter with a 3/16" hook opening x 13/16" overall length
- Cable passes through the top and exits out the side
- No special tools or setting keys required
- Reliable built-in 5 to 1 safety factor
- Nickel plated brass and steel material
- Packaged 200 per bag

ITEM #	FOR USE WITH BARE CABLE DIA.	SAFE WORKING LOAD LIMIT
105158	1/32" (3x7)	7 lbs. (when used with 1/32" cable)
	or 1/16" (7x7)	or 30 lbs. (when used with 1/16" cable)

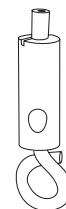

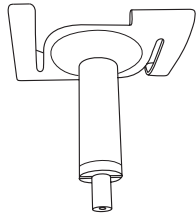

Ceiling Twist Side Exit Cable Adjuster

Suspend lighting, signs and other fixtures directly to common drop-ceiling style grids in a vertical fashion. Twist-on-to-lock ceiling grid attachment design that quickly and easily allows for adjustment of bare cable (sold separately). Adjusters have a unique ball bearing push-button feature with integrated side exit for easy height adjustments. Holes on the top side and underside allow bare cable to pass through. **Warning:** Use only on bare cable (wire rope). Do not use on painted or coated cable. Not recommended for suspension of objects at angles.

- For use on standard 15/16" ceiling grid tee bars
- Turn and lock base is 1-1/2" long x 1" wide with 20 gauge steel painted white
- Cable adjuster body is 1" long x .354" diameter
- Cable passes through the bottom and exits out the side
- No special tools or setting keys required
- Reliable built-in 5 to 1 safety factor
- Nickel plated brass and steel material
- Packaged 100 per bag

ITEM #	FOR USE WITH BARE CABLE DIA.	SAFE WORKING LOAD LIMIT *
105160	1/32" (3x7) or	7 lbs. (when used with 1/32" cable)
	1/16" (7x7)	30 lbs. (when used with 1/16" cable)

* Rating is for cable adjuster only & is not for the ceiling grid. Consult ceiling grid weight specifications.



Looping Cable Adjuster

A fast and easy way to form loops with cable (sold separately) to suspend signs, lighting and other fixtures vertically or at slight angles. Adjusters have a unique ball bearing push-button feature for easy height adjustments. Lightweight, self-locking and reusable. **Warning:** Use only on bare cable (wire rope) in dry, low-humidity locations. Do not use on painted or coated cable. Suspension of objects at angles reduces the safe working load limits (call for details).

- #105155 measures 3/4" length x 3/4" width
- #105156 measures 1-3/16" length x 1-3/16" width
- No special tools or setting keys required
- Up to six (6) times faster to install than historical methods
- Reliable built-in 5 to 1 safety factor
- Aircraft quality aluminum material

ITEM #	FOR USE WITH BARE CABLE DIAMETER	SAFE WORKING LOAD LIMIT	PACKAGED
105155	1/32" (3x7) and 1/16" (7x7)	15 lbs. for 1/32" & 75 lbs. for 1/16"	100 per bag
105156	3/32" (7x7) and 1/8" (7x7)	150 lbs. for 3/32" & 250 lbs. for 1/8"	50 per bag

"Y" Drop Style Cable Assemblies

Simple single point high bay environment ceiling suspender having two integrated leg end attachment points. Perfect for cable baskets and light fixtures. Two common branched leg end styles to choose from. Captive toggle paddle style is designed to conveniently fit into specific hole diameters of common light fixtures. Snap hook style is perfect for cable baskets and trays. Great for use in conjunction with our line of cable adjusters (sold separately – see above).

- Toggle ends are 1-1/2" overall length x 7/32" wide
- Snap hook ends are 3" overall length x 1/4" wire dia. with 5/8" snap opening
- Safe working load limit is 70 pounds
- Cable is 1/16" dia. (7x7) galvanized steel
- End fittings are zinc plated steel
- Other cable diameters and lengths available upon request

ITEM #	CABLE DIA.	CABLE LENGTH	LEG LENGTH	LEG END FITTINGS
109531	1/16" (7x7)	10 ft.	18"	Toggle
109537	1/16" (7x7)	10 ft.	18"	Snap Hook

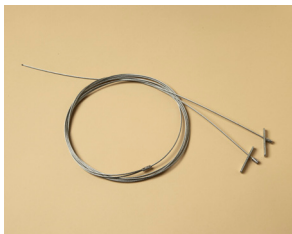
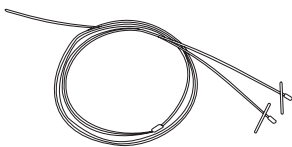

#109531

#109537

Cable & Adjuster Kits

Our highly popular self-locking cable adjuster with a looped end cable together in a convenient kit. Adjust height of signs easily with no tools required. 1/16" diameter cable is very strong. **Warning:** Use only in dry, indoor locations. Suspension of objects at angles reduces the safe working load limits (call for details).

- Cable is 1/16" dia. (7x7) galvanized steel and holds up to 75 lbs.
- Cable is straight cut on one end and has a 3/4" long loop on the other end
- Other cable lengths available upon request
- Each sealed, clear polybagged kit contains one adjuster and one cable, unassembled

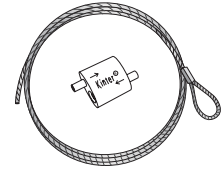

ITEM #	CONTENTS
105125	One Adjuster and One 5 ft. Long Cable
105126	One Adjuster and One 10 ft. Long Cable
105127	One Adjuster and One 15 ft. Long Cable
105128	One Adjuster and One 20 ft. Long Cable
105129	One Adjuster and One 30 ft. Long Cable

"S" Hooks

Nice range of common lengths and diameters for various hanging applications.

- Steel material, stocked in the finishes listed below

ITEM #	WIRE DIAMETER	LENGTH	FINISH
108003	.080"	1"	Bright Galvanized
108003B	.080"	1"	Black Oxide
108004	.093"	7/8"	Bright Galvanized
108005	.120"	1-5/16"	Bright Galvanized
108006	.135"	1-5/8"	Bright Galvanized
108007	.148"	2"	Bright Galvanized
108008	.177"	2-7/8"	Bright Galvanized



Wire Snap Link

Economical spring lock design that snaps easily and locks securely. Popular for directly connecting chain or the ends of cable to grid ceiling loops or banner hanger clips. Extremely strong for its thin wire design. Stainless steel offers corrosion resistance. Clips totally shut for a secure closure. **Warning:** Light duty use only – not designed for lifting.

- 1/32" wire diameter
- 1-1/4" overall length
- 11/16" closed inside loop length
- Other sizes available – please inquire
- Stainless steel material

ITEM #	LENGTH
101074	1-1/4"



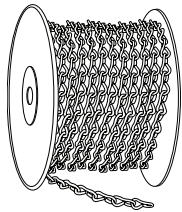

Metal Jack Chain

Single jack chain. Very popular for hanging signs and other items of medium weight.

- Steel material, stocked in the finishes listed below
- Black oxide finish also available for #14 and #12 sizes – please inquire
- Packaged on single plastic spools at the lengths listed below
- Custom lengths available

ITEM #	TRADE SIZE	WIRE DIAMETER	SPOOL LENGTH	MAX. WORKING LOAD LIMIT	FINISH
104001	#16	.062"	250 ft.	10 lbs.	Bright Galvanized
104001B	#16	.062"	250 ft.	10 lbs.	Black Oxide
104002	#14	.080"	250 ft.	16 lbs.	Bright Galvanized
104003	#12	.105"	100 ft.	29 lbs.	Bright Galvanized



Single Jack Chain Lengths

Our most popular, common #16 steel single jack chain in convenient cut-to-length pieces. Very popular for hanging signs and other items of medium weight.

- #16 steel single jack chain (.062" wire diameter)
- 10 lbs. maximum working load limit
- Other wire diameters and working load limits also available
- Steel material, stocked in the finishes listed below
- Custom lengths, finishes or other materials also available

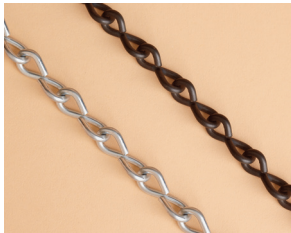

ITEM #	TRADE SIZE	LENGTH	FINISH
104041	#16	12"	Bright Galvanized
104042	#16	24"	Bright Galvanized
104043	#16	36"	Bright Galvanized
104043B	#16	36"	Black Oxide
104044	#16	48"	Bright Galvanized
104044B	#16	48"	Black Oxide
104046	#16	72"	Bright Galvanized

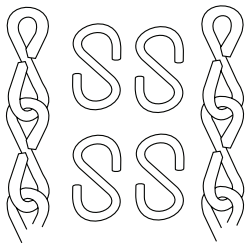

Metal Jack Chain Kit

Our most popular jack chain and "S" hooks packaged together in a convenient kit. Hang signs or displays easily and with confidence.

- Single jack chain is #16 trade size (.062" wire diameter) x 48" long
- Other chain lengths & diameters available upon request
- "S" hooks are 1" long (.080" wire diameter)
- Jack chain and "S" hooks are steel, stocked in the finishes listed below
- Each sealed, clear polybagged kit contains two chains and four hooks



ITEM #	CONTENTS	FINISH
104014	Two 48" in. Long Chains and Four "S" Hooks	Bright Galvanized
104014B	Two 48" in. Long Chains and Four "S" Hooks	Black Oxide

Beaded Chain

Attractive beaded chain is very popular for hanging signs or promotional material from just about anything. Well suited for use on bulky loose leaf material, swatches or samples. Optional accessories include hook ends, connectors and loop forming couplings (all sold separately). Also known as Ball Chain.

- Custom lengths, colors and finishes also available
- Silver nickel plated steel
- Packaged on single plastic spools at the lengths listed below

ITEM #	TRADE SIZE	BALL DIAMETER	SPOOL LENGTH
104010	#3	.093"	100 ft.
104011	#3	.093"	250 ft.
104012	#6	.125"	100 ft.
104013	#6	.125"	250 ft.
104015	#10	.175"	100 ft.
104016	#10	.175"	250 ft.

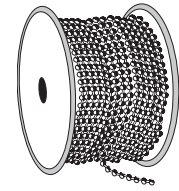

Beaded Chain Assemblies

Our most popular lengths of attractive beaded (ball) chain assemblies with factory installed single connector end. Well suited for use on bulky loose leaf material, swatches or samples, or on signs and promotions. Chain clips together for a secure, fixed length. **Warning:** Connector end may be difficult to link.

- Various lengths available in common #3, #6 and #10 ball chain sizes
- Chains are linkable to make longer chains
- Optional accessories sold separately
- Also available with coupling end for forming adjustable length loops – please inquire
- Custom lengths, colors and finishes available
- Silver nickel plated steel

ITEM #	TRADE SIZE	BALL DIAMETER	OVERALL LENGTH
102049	#3	.093"	4"
102050	#3	.093"	6"
102051	#3	.093"	12"
102052	#3	.093"	24"
102053	#6	.125"	6"
102054	#6	.125"	12"
102055	#6	.125"	24"
102056	#10	.175"	6"
102057	#10	.175"	12"
102058	#10	.175"	24"

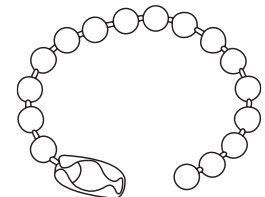

Beaded Chain Accessories

All accessories work in conjunction with our line of beaded/ball chain (sold separately). Connector ends (also known as Links or Clasps) have a solid back and are the most common by simply offering an end attachment at a fixed length. Coupling ends work the same as connector ends, but are more versatile by also offering an integrated, oversized back hole for creating optional adjustable loops. Both types are great when used as connectors for splicing links of beaded chain together for endless assemblies. **Warning:** Connectors and/or couplings may be difficult to link.

- Connectors have a solid backing and are small in size
- Couplings have a hollow, open backing and are a bit larger in size
- Both connectors and couplings are linkable and can be used to make longer chains
- Silver nickel plated metal

ITEM #	CHAIN SIZE	END TYPE	LENGTH
104025	#3	Connector	3/8"
104026	#6	Connector	29/64"
104029	#3	Adjustable Coupling	3/8"
104030	#6	Adjustable Coupling	1/2"
104027	#10	Adjustable Coupling	39/64"

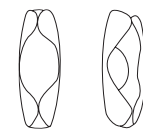

Connector Adjustable Coupling





Steel Cable (Wire Rope) Cutter

Top quality, pocket sized cutter. Use for hand cutting of wire rope and jack chain up to 3/16" diameter. Triangular shear cut blades allow for a clean, sharp end cut without crushing, deforming or fraying.

- High quality alloy steel with formed vinyl coated handles
- Packaged individually

ITEM #	CUTTING CAPACITY	OVERALL LENGTH
105050	up to 3/16" Dia.	8"

NEW

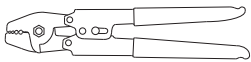

Economy Hand Swager

Our most economical cable tool, yet versatile. Use for hand compression of 1/32", 3/64" and 1/16" aluminum and copper cable sleeves (crimps) and stops. Make three presses (swaged areas) per sleeve. **Warning:** Swaging of fittings over coated cable will result in severely reduced holding power.

- Comfortable, no-slip handle grips
- Locks closed for storage
- High-grade steel, zinc plated

ITEM #	SWAGING CAPACITY	OVERALL LENGTH
105051	1/32," 3/64" or 1/16"	10"

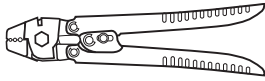

Three Cavity Hand Swager

Multi-cavity tool for use on a variety of common, smaller diameter cables. Use for hand compression of 1/32", 3/64" and 1/16" aluminum and copper cable sleeves (crimps) and stops. Make three presses (swaged areas) per sleeve. Tool also has built-in cable cutter. **Warning:** Swaging of fittings directly over coated wire rope will result in severely reduced holding power.

- Heat treated forged alloy steel jaws
- Packaged individually

ITEM #	SWAGING CAPACITY	OVERALL LENGTH
105052	1/32", 3/64" & 1/16"	10"

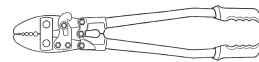

Five Cavity Heavy Duty Swager

Multi-cavity tool for use on a variety of common, larger diameter cables. Use for hand compression of 1/16", 3/32", 1/8", 5/32" and 3/16" aluminum and copper cable sleeves (crimps) and stops. Make three presses (swaged areas) per sleeve. Tool also has built-in cable cutter (7/32" maximum cut).

Warning: Swaging of fittings directly over coated wire rope will result in severely reduced holding power.

- Heat treated forged alloy steel jaws
- Packaged individually

ITEM #	SWAGING CAPACITY	OVERALL LENGTH
105053	1/16", 3/32", 1/8", 5/32" & 3/16"	24"

Cable & Chain



K-Stick™ Ladderless Sign Hanging System





**CHECK
OUT OUR
EVERYDAY
LOW
PRICES**

REDUCE RISK AND COSTS WITH THE K-STICK LADDERLESS SIGN HANGING SYSTEM

K-Stick is versatile, lightweight and works with all ceiling types, windows and walls. No wonder K-Stick is eliminating ladder falls in over 15,000 retail locations nationwide. For your FREE K-Stick Sample Kit go to kstick.com or call 800.323.2389.



K-Stick™ Ladderless Sign Hanging System

K-Stick® Ladderless Pole

Hang, remove or rotate ceiling, wall and window signs and banners from ground level, without the need for a ladder. Quick and safe! Fixed single length economy style or smooth telescopic poles for use with all of our magnetic, cleat or hook style ladderless sign hanging system holders and accessories. Each K-Stick includes our **Patented & Patent Pending** "easy pivot" 6-1/4" long green plastic gripper pole end with attached yellow braided pull cord (some minor assembly required; instruction sheet included). For best sign hanging results, keep the pole vertical as it is extended to the ceiling. Use two or more poles when raising or lowering larger signs.

- Otherwise known as Installation Poles or Extension Poles
- Integrated 3/4" diameter reinforced acme threaded black plastic end/tip
- Clear satin anodized finish with black hand grip
- Telescopic styles offer reliable twist-lock features
- Sold as a full unit only – separate replacement parts are not available
- Lightweight aluminum material

ITEM #	EXTENDED LENGTH	FOR MAXIMUM CEILING HEIGHTS	COLLAPSED LENGTH	NUMBER OF SECTIONS
220020	4 ft.	10 ft.	48"	1
220022	10 ft.	15 ft.	47"	3
220024	18 ft.	23 ft.	65"	4

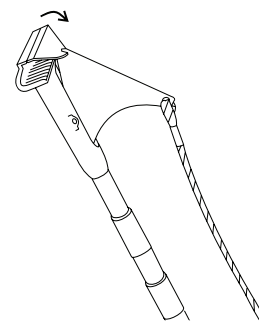

For more information, go to kstick.com

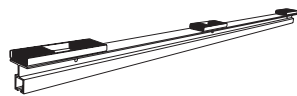

Ladderless Magnetic Banner Hanger

A safe and simple way to hang signs and banners from metal ceiling grids/surfaces that are up to 23 feet in height. One piece, strong magnetic design with integrated holes and a “C” channel bottom track that accepts various sign hanging options such as plastic and metal hooks, clips, rings, cable or chain (all sold separately). For use from ground level with our K-Stick Ladderless Poles (see page 277). Simply pick a sign hanging option, attach to both the hanger and the edge of the graphic, elevate, align into position and release – it’s that easy! Removable and reusable – all safely from floor level. **Warning:** Metal conditions will affect holding power. Magnets should not be used near electronic equipment. **Patented.**

- 7/8" wide x 1-1/8" overall height (including attached ceramic magnets)
- Three 3/16" diameter hanging holes (two end holes and one center hole)
- Not recommended for use on ceiling grid perimeters
- Custom lengths and colors available – please inquire
- White PVC with nickel plated steel magnets

ITEM #	LENGTH	NUMBER OF MAGNETS	SAFE WORKING LOAD LIMIT ON WINDOWS *	SAFE WORKING LOAD LIMIT ON CEILING *
220507	14"	2	3 lbs.	4 lbs.
220508	26"	3	3 lbs.	4 lbs.
220509	36"	4	3 lbs.	4 lbs.



Ladderless 360 Degree Magnetic Banner Hanger

A safe and simple way to hang signs and banners from metal ceiling grids/surfaces that are up to 23 feet in height. Unlike our stationary ladderless options, this hanger turns a full 360 degrees, thus allowing your signage to be faced at optimal viewing angles. Strong magnetic design with integrated holes and a “C” channel bottom track that accepts various sign hanging options such as plastic and metal hooks, clips, rings, cable or chain (all sold separately). For both placing and pivoting from ground level, use our K-Stick Ladderless Poles (see page 277). Simply pick a sign hanging option, attach to both the hanger and the edge of the graphic, elevate, align into position and release – it’s that easy! Removable and reusable – all safely from floor level. **Warning:** Metal conditions will affect holding power. Magnets should not be used near electronic equipment. **Patented.**

- 1-1/8" wide x 1-5/8" overall joined height (including attached ceramic magnets)
- Two 3/16" diameter hanging holes (one at each end)
- Not recommended for use on ceiling grid perimeters
- Custom lengths and colors available – please inquire
- White PVC with nickel plated steel magnets

ITEM #	LENGTH	NUMBER OF MAGNETS	SAFE WORKING LOAD LIMIT *
220531	14"	2	3 lbs.
220532	26"	3	3 lbs.
220533	36"	4	3 lbs.

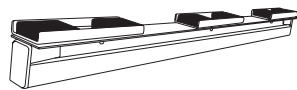

Ladderless Magnetic Banner Hanger – Heavy Duty

An even stronger version of our popular Ladderless Magnetic Banner Hanger. With three separate 3" long ceramic magnets attached closer together, this heavy duty banner hanger will stand up to any competitor’s neodymium magnetic holders. A safe and simple way to hang larger, heavier signs from metal ceiling grids/surfaces that are up to 23 feet in height. One piece, strong magnetic design with attached end cap retainers, integrated holes and a “C” channel bottom track that accepts various sign hanging options such as metal hooks, clips, rings, cable or chain (all sold separately). For use from ground level with our K-Stick Ladderless Poles (see page 277). Simply pick a sign hanging option, attach to both the hanger and the edge of the graphic, elevate, align into position and release – it’s that easy! Removable and reusable – all safely from floor level. **Warning:** Metal conditions will affect holding power. Magnets should not be used near electronic equipment. **Patented.**

- 7/8" wide x 1-1/8" overall height (including attached ceramic magnets)
- Three 3/16" diameter hanging holes (two end holes and one center hole)
- Attached white end cap retainers included
- For best strength results, hang signs from the two end holes or in a sling-like fashion – please inquire
- Not recommended for use on ceiling grid perimeters or with our Ladderless Mounting Plates
- Custom colors available
- White PVC with nickel plated steel magnets

ITEM #	LENGTH	NUMBER OF MAGNETS	SAFE WORKING LOAD LIMIT *
220517	14"	3	5 lbs. (when used with K-Stick Pole) or 8 lbs. (without K-Stick Pole)

* Safe working load limit is based on a single banner hanger having a minimum of two sign hanging points

Ladderless Magnetic “C” Channel Banner Hanger

When used with our Ladderless Mounting Strips (sold separately), this ingenious 90 degree sign hanger makes it both safe and simple to magnetically hang and display signs and posters from the inside of window frames. Can also be used in conjunction with our Ladderless Mounting Plates (sold separately) to hang signs directly from drywall ceilings. Also works well on ceiling grids and the lip of ceiling grid perimeters. One piece, strong magnetic design with integrated holes and a “C” channel bottom track that accepts various sign hanging options, such as plastic and metal hooks, clips, rings, cable or chain (all sold separately). Also use in conjunction with our Plastic Banner Dowel Rod (sold separately) to display sewn/hemmed fabric or vinyl banners for a clean finished appearance. For use from ground level with our K-Stick Ladderless Poles (see page 277). Removable and reusable – all safely from floor level. **Warning:** Metal conditions will affect holding power. Magnets should not be used near electronic equipment. **Patented.**

- 2" wide x 2" overall height (including attached ceramic magnets)
- Three 3/16" diameter hanging holes (two end holes and one center hole)
- Not recommended for outdoor use
- Custom lengths and colors available – please inquire
- White PVC with nickel plated magnets

ITEM #	LENGTH	NUMBER OF MAGNETS	SAFE WORKING LOAD LIMIT *
220521	26"	3	3 lbs.
220522	36"	4	3 lbs.
220523	48"	5	3 lbs.

* Safe working load limit is based on a single banner hanger having a minimum of two sign hanging points

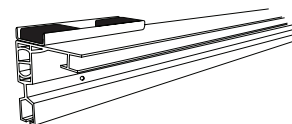

Ladderless Magnetic Gripper Apollo Banner Hanger

When used with our Ladderless Mounting Strips (sold separately), this ingenious, 90 degree hinged sign hanger makes it both safe and simple to magnetically hang and display signs and posters from the inside of window frames. Can also be used in conjunction with our Ladderless Mounting Plates (sold separately) to hang signs directly from drywall ceilings. Also works well on ceiling grids and the lip of ceiling grid perimeters. For use from ground level with our K-Stick Ladderless Poles (see page 277). Designed to quickly and easily attach a banner to the hanger. Just snap open, insert sign and snap down to close. Removable and reusable – all safely from floor level. **Warning:** Metal conditions will affect holding power. Magnets should not be used near electronic equipment. **Patented.**

- 2" wide x 1-7/8" overall height (including attached ceramic magnets)
- Not recommended for outdoor use
- Custom lengths and colors available – please inquire
- White PVC with nickel plated steel magnets

ITEM #	GRIP CAPACITY	LENGTH	NUMBER OF MAGNETS	SAFE WORKING LOAD LIMIT
220551	up to .040"	26"	3	3 lbs.
220552	up to .040"	36"	4	3 lbs.
220553	up to .040"	48"	5	3 lbs.

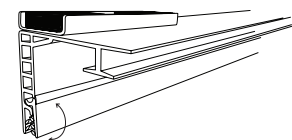

Ladderless Magnetic Gripper Banner Hanger

When used with our Ladderless Mounting Strips (sold separately), this ingenious 90 degree sign hanger makes it both safe and simple to magnetically hang and display signs and posters from the inside of window frames. Can also be used in conjunction with our Ladderless Mounting Plates (sold separately) to hang signs directly from drywall ceilings. Also works well on ceiling grids and the lip of ceiling grid perimeters. For use from ground level with our K-Stick Ladderless Poles (see page 277). Gripper fins hold heavier or longer length signs securely. Removable and reusable – all safely from floor level. **Warning:** Metal conditions will affect holding power. Magnets should not be used near electronic equipment. **Patented.**

- 2" wide x 1-1/4" overall height (including attached ceramic magnets)
- Two 5/32" diameter cross-member mounting holes – one on each side
- Not recommended for outdoor use
- Custom lengths and colors available – please inquire
- White PVC with nickel plated magnets

ITEM #	GRIP CAPACITY	LENGTH	NUMBER OF MAGNETS	SAFE WORKING LOAD LIMIT
220561	.100" to .250"	26"	3	3 lbs.
220562	.100" to .250"	36"	4	3 lbs.
220563	.100" to .250"	48"	5	3 lbs.

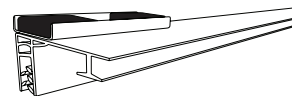

Ladderless Magnetic Atlas Banner Hanger

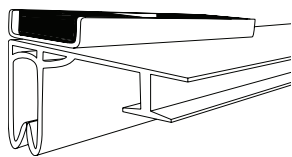

When used with our Ladderless Mounting Strips (sold separately), this ingenious, 90 degree sign hanger makes it both safe and simple to magnetically hang and display signs from the inside of window frames. Can also be used in conjunction with our Ladderless Mounting Plates (sold separately) to hang signs directly from drywall ceilings. Also works well on ceiling grids and the lip of ceiling grid perimeters. For use from ground level with our K-Stick Ladderless Poles (see page 277). Slides directly onto the top edge of banners or posters for a secure friction fit. Removable and reusable – all safely from floor level. **Warning:** Metal conditions will affect holding power. Magnets should not be used near electronic equipment. **Patented.**

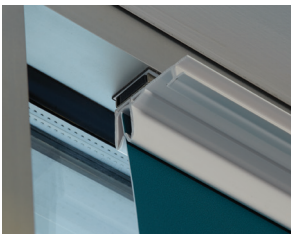

- 2" wide x 1-1/4" overall height (including attached ceramic magnets)
- Not recommended for outdoor use
- Custom lengths and colors available – please inquire
- White PVC with nickel plated steel magnets

ITEM #	GRIP CAPACITY	LENGTH	NUMBER OF MAGNETS	SAFE WORKING LOAD LIMIT
220527	up to .125"	26"	3	3 lbs.
220528	up to .125"	36"	4	3 lbs.
220529	up to .125"	48"	5	3 lbs.

Magnetic Ladderless Ceiling Clip & Cord

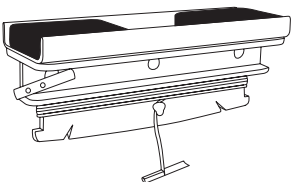

A magnetic version of our highly popular Ceiling Twist Clip & Cord. Use to suspend lightweight signs, mobiles, banners and seasonal decorations. Easily attaches magnetically to ceiling grids or other exposed metal overhead ceiling fixtures/supports. Unravel wound barbed cord to desired length. Built-in slits allow for micro adjustments of cord lengths for even hanging. Works with our K-Stick Ladderless Poles (see page 277) for simple installation and removal from ground level. **Warning:** Always test suitability on a per-application basis. Metal conditions will affect holding power. Magnets should not be used near electronic equipment. **Patented.**



- 3" long x 7/8" wide x 1-1/4" overall height (including attached ceramic magnet)
- Clip has three evenly spaced .156" diameter holes
- Also available with black cord – please inquire
- White styrene clip with nickel plated steel magnet

ITEM #	CORD LENGTH	CORD COLOR	CORD MATERIAL	SAFE WORKING LOAD LIMIT
220075	10 ft.	White	Braided Polyester	1 lbs.
220075C	10 ft.	Clear	Monofilament	1 lbs.

Magnetic Ladderless Ceiling Clip With Holes

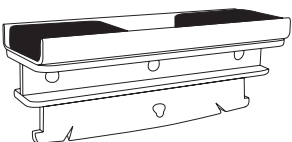

Use to suspend lightweight signs, mobiles, banners and seasonal decorations. Easily attaches magnetically to ceiling grids or other exposed metal overhead ceiling fixtures/supports. Small holes make it great for attaching wire hooks and barbed cords (sold separately). Works with our K-Stick Ladderless Poles (see page 277) for simple installation and removal from ground level. **Warning:** Always test suitability on a per-application basis. Metal conditions will affect holding power. Magnets should not be used near electronic equipment. **Patented.**



- 3" long x 7/8" wide x 1-1/4" overall height (including attached ceramic magnet)
- Clip has three evenly spaced .156" diameter holes
- White styrene clip with nickel plated steel magnet

ITEM #	LENGTH	NUMBER OF HOLES	HOLE DIAMETER	SAFE WORKING LOAD LIMIT
220070	3"	3	5/32"	1 lbs.

Magnetic Ladderless Ceiling Clothes Hanger Adapter

A safe and simple way to suspend and display varieties of garments for any occasion, message or season. This inexpensive hanger adapter easily attaches magnetically to ceiling grids or other exposed metal overhead ceiling fixtures/supports. Further, when combined with our Ladderless Mounting Strips (see page 288), this ingenious hanger also makes it easy to place or change out clothes from the inside of window frames. For use from ground level with our K-Stick Ladderless Poles (see page 277). Create full 360 degree optimal clothing viewing angles by combining with swiveling hook clothes hangers (not included). For extra hanging length from taller ceilings or windows, simply combine with our Block End Hooks and/or End Cap Retainers (see page 289). **Warning:** Metal conditions will affect holding power. Magnets should not be used near electronic equipment.

- 7/8" wide x 6" long x 1-1/8" overall height (including attached ceramic magnets)
- .406" long slotted hole size on one end for hooking of clothes hanger
- Can be used with either stationary (non-swiveling) or swivel hook style clothes hangers – not included
- Not for use with oversized plastic clothes hangers or with our line of ladderless mounting plates for drywall ceilings
- White PVC with nickel plated magnets
- Custom colors also available – please inquire

ITEM #	LENGTH	NUMBER OF MAGNETS	SAFE WORKING LOAD LIMIT *
220071	6"	2	2 lbs.

* Includes the weight of the clothes hanger being used



Shown with Block End Hook

Ladderless Magnetic "C" Channel Wall Banner Hanger

When used with our Ladderless Mounting Plates (sold separately), this ingenious 90 degree sign hanger makes it both safe and simple to magnetically hang and display signs flush from walls. One piece, strong magnetic design with integrated holes and a "C" channel bottom track that accepts various sign hanging options, such as plastic and metal hooks, clips, rings, cable or chain (all sold separately). Also use in conjunction with our Plastic Banner Dowel Rod (sold separately) to display sewn/hemmed fabric or vinyl banners for a clean finished appearance. For use from ground level with our K-Stick Ladderless Poles (see page 277). Removable and reusable – all safely from floor level.

Warning: Metal conditions will affect holding power. Magnets should not be used near electronic equipment. **Patented.**

- 2-1/4" wide x 1-3/4" overall height (including attached ceramic magnets)
- Three 3/16" diameter hanging holes (two end holes and one center hole)
- Not recommended for outdoor use
- Custom lengths and colors available – please inquire
- White PVC with nickel plated magnets

ITEM #	LENGTH	NUMBER OF MAGNETS	SAFE WORKING LOAD LIMIT *
220556	26"	3	3 lbs.
220557	36"	4	3 lbs.
220558	48"	5	3 lbs.

* Safe working load limit is based on a single banner hanger having a minimum of two sign hanging points

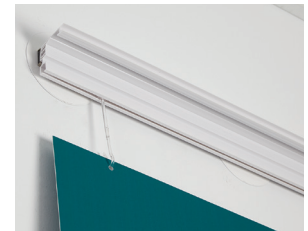
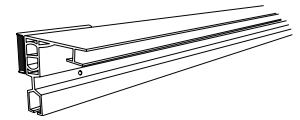

Ladderless Magnetic Gripper Apollo Wall Banner Hanger

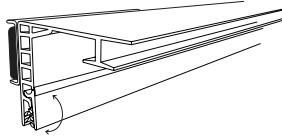

When used with our Ladderless Mounting Plates (sold separately), this ingenious, 90 degree hinged sign hanger makes it both safe and simple to magnetically hang and display signs and posters flush from walls. For use from ground level with our K-Stick Ladderless Poles (see page 277). Designed to quickly and easily attach a banner to the hanger. Just snap open, insert sign and snap down to close. Removable and reusable – all safely from floor level. **Warning:** Metal conditions will affect holding power. Magnets should not be used near electronic equipment. **Patented.**

- 2-1/4" wide x 1-1/2" overall height (including attached ceramic magnets)
- Not recommended for outdoor use
- Custom lengths and colors available – please inquire
- White PVC with nickel plated steel magnets

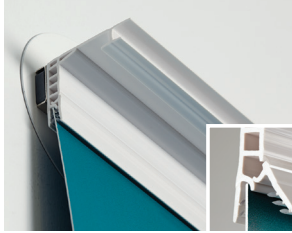

ITEM #	GRIP CAPACITY	LENGTH	NUMBER OF MAGNETS	SAFE WORKING LOAD LIMIT
220546	up to .040"	26"	3	3 lbs.
220547	up to .040"	36"	4	3 lbs.
220548	up to .040"	48"	5	3 lbs.

Ladderless Magnetic Gripper Wall Banner Hanger

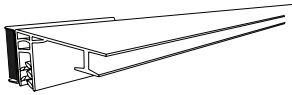

When used with our Ladderless Mounting Plates (sold separately), this ingenious 90 degree sign hanger makes it both safe and simple to magnetically hang and display signs flush from walls. For use from ground level with our K-Stick Ladderless Poles (see page 277). Gripper fins hold heavier or longer length signs securely. Removable and reusable – all safely from floor level. **Warning:** Metal conditions will affect holding power. Magnets should not be used near electronic equipment. **Patented.**

- 2-1/4" wide x 1" overall height (including attached ceramic magnets)
- Two 5/32" diameter cross-member mounting holes – one on each side
- Not recommended for outdoor use
- Custom lengths and colors available – please inquire
- White PVC with nickel plated magnets

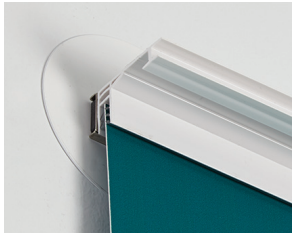

ITEM #	GRIP CAPACITY	LENGTH	NUMBER OF MAGNETS	SAFE WORKING LOAD LIMIT
220572	.100" to .250"	26"	3	3 lbs.
220573	.100" to .250"	36"	4	3 lbs.
220574	.100" to .250"	48"	5	3 lbs.

Ladderless Magnetic Atlas Wall Banner Hanger

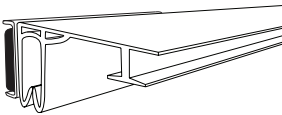

When used with our Ladderless Mounting Plates (sold separately), this ingenious, 90 degree sign hanger makes it both safe and simple to magnetically hang and display signs flush from walls. For use from ground level with our K-Stick Ladderless Poles (see page 277). Slides directly onto the top edge of banners or posters for a secure friction fit. Removable and reusable – all safely from floor level. **Warning:** Metal conditions will affect holding power. Magnets should not be used near electronic equipment. **Patented.**

- 2-1/4" wide x 1" overall height (including attached ceramic magnets)
- Not recommended for outdoor use
- Custom lengths and colors available – please inquire
- White PVC with nickel plated steel magnets

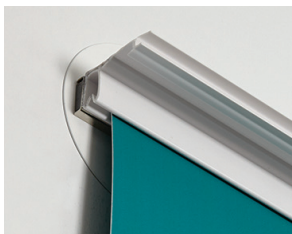

ITEM #	GRIP CAPACITY	LENGTH	NUMBER OF MAGNETS	SAFE WORKING LOAD LIMIT
220503	up to .125"	26"	3	3 lbs.
220504	up to .125"	36"	4	3 lbs.
220516	up to .125"	48"	5	3 lbs.

Ladderless Stackable Spiral Sign Board

Add promotional signs or change pricing easily. Removable and reusable – all safely from floor level. When used with our Ladderless Magnetic Gripper Banner Hanger #220561 and our Stackable Push-In Fastener #120411 (both sold separately) this modular, double sided sign board holds and displays common Spiral Sign Board Pads (also sold separately – see page 92). Side-access spiral sign pads insert and remove easily to change prices. Attach one spiral sign board to another in a “ladder” fashion to create dual messaging, or combine with our Stackable “C” Channel Sign Board(s) to add single or multiple top/bottom sign inserts. **Warning:** Each sign board connection must be securely held together with our Stackable Push-In Fasteners #120411. **Patented.**

- Two 1/4" diameter top mounting/hanging holes (one at each end)
- Upper mounting track section holds common 3/8" diameter spiral bound sign pads
- Lower “J” style mounting track section holds pads up to 5/32" thick
- Also accepts 8-1/4" tall sign inserts up to 5/32" thick
- Custom colors, lengths, heights or one sided boards also available – please inquire
- White high impact polystyrene (HIPS) material

ITEM #	OVERALL LENGTH	OVERALL HEIGHT	FOR SPIRAL SIGN PADS
220651	26"	9-3/8"	8" Tall

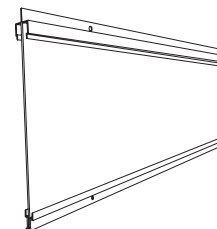

Shown with “C” Channel Board

Ladderless Stackable “C” Channel Sign Board

Add promotional signs or change message inserts easily. Removable and reusable – all safely from floor level. When used with our Ladderless Magnetic Gripper Banner Hanger #220561 and our Stackable Push-In Fastener #120411 (both sold separately) this modular, double sided track holds and displays multi-pricing inserts and directory or aisle identification signs. Attach one “C” channel sign board to another in a “ladder” fashion to create dual messaging, or combine with our Stackable Spiral Sign Board(s) to add single or multiple top/bottom spiral bound pricing information.

Warning: Each sign board connection must be securely held together with our Stackable Push-In Fasteners #120411. **Patented.**

- Two 1/4" diameter top mounting/hanging holes (one at each end)
- Open face design on both sides accepts 5-1/2" tall signs that are up to 3/32" thick
- For taller signs simply use multiple stacked channels
- Custom colors, lengths, heights or one sided boards also available – please inquire
- White high impact polystyrene (HIPS) material

ITEM #	OVERALL LENGTH	OVERALL HEIGHT	FOR SIGN INSERTS
220626	26"	6-5/8"	5-1/2" Tall

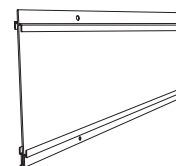

Shown with Spiral Board

Stackable Push-In Fastener

Use to connect our line of modular “C” channel and spiral sign boards to each other in a “ladder” fashion (one below the other), or to make each “ladderless” by attaching to our Magnetic Gripper Banner Hanger #220561 – all sold separately. Acts as a cross-member when pressed into mating holes along the top or bottom edges of our family of stackable message boards. Hollow body design allows the clip to compress when pushed into hole, then expand back for a secure hold that resists removal. No tools required. Removable and reusable.

- Press fit into 5/32" diameter pre-drilled/punched holes
- Proper installation occurs when the head is seated completely to the mating sign board or banner hanger
- Natural 6/6 nylon material
- Also available in black or special colors – please inquire

ITEM #	SHANK LENGTH	HEAD O.D.	HEAD STYLE
120411	.530"	.270"	Round



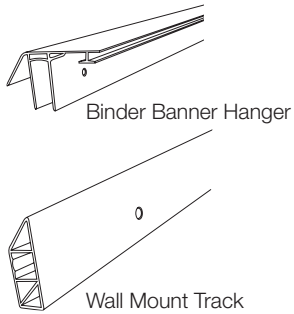

Ladderless Binder Cleat Wall Banner Hanger

Are you looking to mount large signs directly to walls? If so, we have the solution! This ingenious two piece, interlocking wedge-shaped banner hanger assembly makes it safe and simple to display and change out signs of almost any size directly from walls. Each assembly consists of one wall mount track and one binder banner hanger piece – both sold separately. Simply prep the wall by screwing the wall mount track piece to the wall (mounting hardware included) and then fasten the binder banner hanger piece onto the top edge of the sign (barrel bolt and screw fastening hardware included) and gravity does the rest. Signs hang approximately 1 inch offset from wall which, when combined at the bottom of the sign with our #150675 Square Foam Blocks (see below), creates a handsome dimensional effect. Removable and reusable – all safely from floor level. For use from ground level with our K-Stick Ladderless Poles (see page 277). **Warning:** Not recommended for outdoor use. Wall mount track must be firmly attached to wall. Male and female barrel bolt fastening hardware must be fully screwed together. **Patented.**

- Wall mount track and binder banner hanger piece are each sold separately
- Wall mount track has holes at 16" on center and comes with toggle screw anchors, stud screws and an instruction sheet
- Pre-drilling of holes for wall mount track is required (drill bit sold separately – see page 291)
- Wall mount track piece is 3" tall x 1" wide
- Binder banner hanger piece has multiple 5/16" diameter holes – please inquire for recommended sign hole size and placement
- Binder banner hanger piece comes with white painted steel male and female barrel bolt fastening hardware and an instruction sheet
- Binder banner hanger piece is 1-3/4" tall x 2-1/2" wide
- Custom colors and lengths available – please inquire
- White PVC material



ITEM #	LENGTH	GRIP CAPACITY	ASSEMBLY TYPE	SAFE WORKING LOAD LIMIT *
220641	24"	n/a	Wall Mount Track	5 lbs.
220642	36"	n/a	Wall Mount Track	5 lbs.
220643	48"	n/a	Wall Mount Track	5 lbs.
220645	72"	n/a	Wall Mount Track	5 lbs.
220631	24"	up to 5/8"	Binder Banner Hanger	5 lbs.
220632	36"	up to 5/8"	Binder Banner Hanger	5 lbs.
220633	48"	up to 5/8"	Binder Banner Hanger	5 lbs.
220635	72"	up to 5/8"	Binder Banner Hanger	5 lbs.

* For larger, heavier signs over 5 pounds it is possible to have two or more individuals, each with a K-Stick, raise or lower simultaneously (call for details).

Foam Block Stand-Off

Foam block stand-offs add dimension to displays and signage. Used to create a 3-D effect that makes your graphics stand out. Place foam blocks 1"-2" from the edge of your graphic to create multi-layered displays for added depth. Can also be used to create gondola shelf wobblers or aisle violators.

- 1" H x 1" W x 1" L square blocks
- Permanent adhesive on two opposing sides – simply peel and stick
- Can be stuck together to create longer stand-offs
- White foam material
- 36 kiss-cut blocks per sheet
- Sold in full sheets only

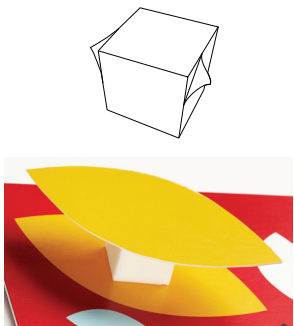

ITEM #	LENGTH	WIDTH	HEIGHT	COLOR
150675	1"	1"	1"	White

Ladderless “C” Channel Cleat Wall Banner Hanger

Are you looking to hang large vinyl, sewn/hemmed banner type signs directly from walls? If so, we have the solution! This ingenious two piece, interlocking wedge-shaped banner hanger assembly makes it safe and simple to display and change out banners of almost any size directly from walls. Each assembly consists of one wall mount track and one banner hanger piece – both sold separately. Also requires our Plastic Banner Dowel Rod (sold separately – see page 288) to display sewn/hemmed fabric or vinyl banners for a clean finished appearance. “C” channel bottom section also accepts various sign hanging options, such as plastic block end hooks or our line of ladderless clips. Simply prep the wall by screwing the wall mount track piece to the wall (mounting hardware included) and then fasten the “C” channel hanger piece onto the top edge of the banner and gravity does the rest. Signs hang approximately 1 inch offset from wall which creates a handsome dimensional effect. Removable and reusable – all safely from floor level. For use from ground level with our K-Stick Ladderless Poles (see page 277). **Warning:** Not recommended for outdoor use. Wall mount track must be firmly attached to wall. **Patented.**

- Wall mount track and “C” channel banner hanger piece are each sold separately
- Wall mount track has holes at 16" on center and comes with toggle screw anchors, stud screws and an instruction sheet
- Pre-drilling of holes for wall mount track is required (drill bit sold separately – see page 291)
- Wall mount track piece is 3" tall x 1" wide
- “C” channel banner hanger piece accepts our line of Plastic Banner Dowel Rods (sold separately – see page 288)
- “C” channel banner hanger piece is 1-3/4" tall x 2-1/4" wide
- Custom colors and lengths available – please inquire
- White PVC material

ITEM #	LENGTH	ASSEMBLY TYPE	SAFE WORKING LOAD LIMIT *
220641	24"	Wall Mount Track	5 lbs.
220642	36"	Wall Mount Track	5 lbs.
220643	48"	Wall Mount Track	5 lbs.
220645	72"	Wall Mount Track	5 lbs.
220668	24"	“C” Channel Banner Hanger	5 lbs.
220669	36"	“C” Channel Banner Hanger	5 lbs.
220670	48"	“C” Channel Banner Hanger	5 lbs.
220672	72"	“C” Channel Banner Hanger	5 lbs.

* For larger, heavier signs over 5 pounds it is possible to have two or more individuals, each with a K-Stick, raise or lower simultaneously (call for details).

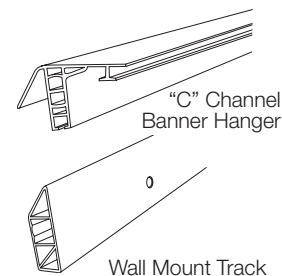

Ladderless Cleat Banner Hanger For Glass

Are you looking to mount signs directly to glass and windows? If so, we have the solution! This ingenious two piece, interlocking wedge-shaped banner hanger assembly makes it safe and simple to display and change out signs and posters directly from glass surfaces. Each assembly consists of one suction cup track piece and one banner hanger piece – both sold separately. Simply prep the window by affixing the suction cup track piece to the glass and then slide the Atlas friction fit banner hanger piece onto the top edge of the graphic and gravity does the rest. For use from ground level with our K-Stick Ladderless Poles (see page 277). Removable and reusable – all safely from floor level.

Warning: Suction cup release tabs must not face directly upward or mating banner hanger may catch and cause cups to release. Apply cups to clean, non-porous surface for best results. **Patented.**

- Suction Cup Track and Atlas Banner Hanger are each sold separately
- Suction cup track piece comes with 2-1/2" O.D. pre-assembled suction cups, measures 1-1/2" in total height, and requires a minimum of 2-1/2" of clearance from the top of window frame
- Atlas friction fit banner hanger piece is 2" wide x 1" overall height
- Not recommended for outdoor use
- Custom colors and lengths available – please inquire
- Clear PVC material

ITEM #	LENGTH	GRIP CAPACITY	NUMBER OF SUCTION CUPS	ASSEMBLY TYPE	SAFE WORKING LOAD LIMIT
220601C	22"	n/a	2	Suction Cup Track	2 lbs.
220602C	24"	n/a	2	Suction Cup Track	2 lbs.
220604C	36"	n/a	3	Suction Cup Track	2 lbs.
220605C	48"	n/a	4	Suction Cup Track	2 lbs.
220606C	22"	up to .125"	n/a	Atlas Banner Hanger	2 lbs.
220607C	24"	up to .125"	n/a	Atlas Banner Hanger	2 lbs.
220609C	36"	up to .125"	n/a	Atlas Banner Hanger	2 lbs.
220610C	48"	up to .125"	n/a	Atlas Banner Hanger	2 lbs.

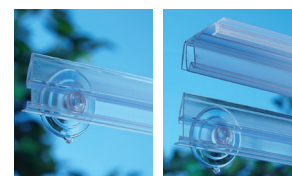
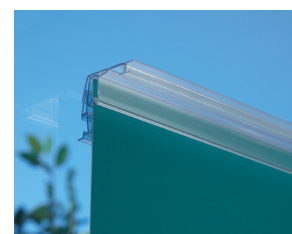
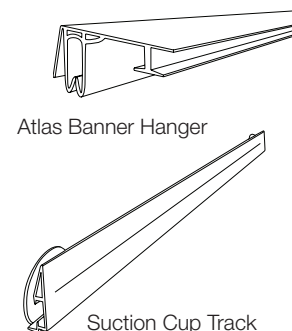

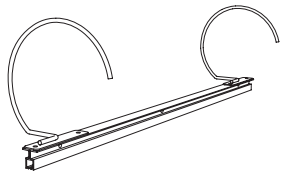

Optional Mini Hook shown

Ladderless Hook Banner Hanger

A safe and simple way to hang signs and banners from exposed metal overhead ceiling fixtures or supports that are up to 23 feet in height. One-piece, strong shepherd shaped open hook design with integrated holes and a "C" channel bottom track that accepts various sign hanging options such as plastic and metal hooks, clips, rings, cable or chain (all sold separately). For use from ground level with our K-Stick Ladderless Poles (see page 277). Two hook sizes available: larger diameter "standard" hooks are ideal for hanging from larger fixtures; smaller diameter "mini" hooks are great when hanging from smaller ceiling fixtures or supports of 1-1/4" diameter or less. Simply pick a sign hanging option, attach to both the hanger and the edge of the graphic, elevate, hook into position and release. Removable & reusable – all safely from floor level. **Patented.**

- 7/8" wide x 15/16" height extrusion size
- Attached .148" diameter wire metal shepherd shaped hooks are available in two different sizes
- Three 3/16" diameter hanging holes (two end holes and one center hole)
- Custom lengths and colors available – please inquire
- White PVC with zinc plated metal hooks

ITEM #	LENGTH	HOOK STYLE	HOOK I.D.	# OF HOOKS	SAFE WORKING LOAD LIMIT *
220512	26"	Standard	6"	2	4 lbs.
220480	26"	Mini	2-1/2"	2	4 lbs.
220513	36"	Standard	6"	2	4 lbs.
220481	36"	Mini	2-1/2"	2	4 lbs.

Ladderless 360 Degree Hook Banner Hanger

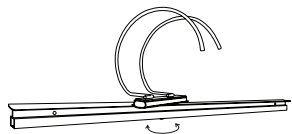

A safe and simple way to hang signs and banners from exposed overhead ceiling fixtures or supports that are up to 23 feet in height. Unlike our stationary ladderless options, this hanger turns a full 360 degrees, thus allowing your signage to be faced at optimal viewing angles. Two hook sizes available: larger diameter "standard" hooks are ideal for hanging from larger fixtures; smaller diameter "mini" hooks are great when hanging from smaller ceiling fixtures or supports of 1-1/4" diameter or less. Strong shepherd open hook design with integrated holes and a "C" channel bottom track that accepts various sign hanging options such as plastic and metal hooks, clips, rings, cable or chain (all sold separately). For both placing and pivoting from ground level, use our K-Stick Ladderless Poles (see page 277). Simply pick a sign hanging option, attach to both the hanger and the edge of the graphic, elevate, hook into position and release. Removable & reusable – all safely from floor level. **Patented.**

- 1-1/8" wide x 1-7/16" height joined extrusion size
- Attached .148" diameter wire metal shepherd shaped hooks are available in two different sizes
- Two 3/16" diameter hanging holes (one at each end)
- Custom lengths and colors available – please inquire
- White PVC with zinc plated metal hooks

ITEM #	LENGTH	HOOK STYLE	HOOK I.D.	# OF HOOKS	SAFE WORKING LOAD LIMIT *
220536	26"	Standard	6"	2	3 lbs.
220485	26"	Mini	2-1/2"	2	3 lbs.
220537	36"	Standard	6"	2	3 lbs.
220486	36"	Mini	2-1/2"	2	3 lbs.

Ladderless Hook Banner Hanger – Heavy Duty

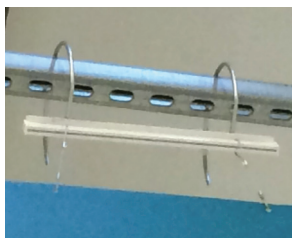
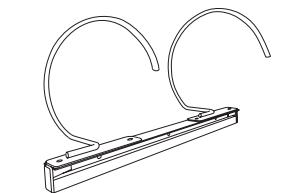

An even stronger version of our popular Ladderless Hook Banner Hanger. By simply placing our shepherd shaped open hooks closer together, this heavy duty banner hanger is a safe and simple way to hang larger, heavier signs from exposed overhead ceiling fixtures or supports that are up to 23 feet in height. Two hook sizes available: larger diameter "standard" hooks are ideal for hanging from larger fixtures; smaller diameter "mini" hooks are great when hanging from smaller ceiling fixtures or supports of 1-1/4" diameter or less. One-piece, strong hook design with attached end cap retainers, integrated holes and a "C" channel bottom track that accepts various sign hanging options such as metal hooks, clips, rings, cable or chain (all sold separately). For use from ground level with our K-Stick Ladderless Poles (see page 277). Simply pick a sign hanging option, attach to both the hanger and the edge of the graphic, elevate, hook into position and release. Removable & reusable – all safely from floor level. **Patented.**

- 7/8" wide x 15/16" height extrusion size
- Attached .148" diameter wire metal shepherd shaped hooks are available in two different sizes
- Three 3/16" diameter hanging holes (two end holes and one center hole)
- Attached white end cap retainers included
- For best strength results, hang signs from the two end holes or in a sling-like fashion – please inquire
- Custom colors available
- White PVC with zinc plated metal hooks

ITEM #	LENGTH	HOOK STYLE	HOOK I.D.	# OF HOOKS	SAFE WORKING LOAD LIMIT *
220519	14"	Standard	6"	2	5 lbs. (when used with K-Stick Pole) or 8 lbs. (without K-Stick Pole)
220489	14"	Mini	2-1/2"	2	5 lbs. (when used with K-Stick Pole) or 8 lbs. (without K-Stick Pole)

* Safe working load limit is based on a single banner hanger having a minimum of two sign hanging points

Adjustable Trapeze Banner Hanger System

Permanently lower your reach on very high ceilings to easily accessible heights. A quick and inexpensive way to suspend signs and displays horizontally from exposed solid or split beam open style warehouse ceilings. Can be used with our full line of Ladderless Hook Banner Hangers, or can be combined with Pear Clips or Snap Rings (sold separately) to lock signs into place. Also great for displaying sewn/hemmed fabric or vinyl banners. No tools required. Each complete assembly requires one support tube and two or more cable assemblies – each sold separately. Each cable assembly includes our highly popular self-locking cable adjuster with a looped cable end assembly connected to a snap-on conduit hanging clip together in a convenient polybagged kit. **Warning:** Use only in dry, indoor locations with conduit hanging clips placed a minimum of 3/4" inward from each end on the support tube.

- Cable is 1/16" dia. (7x7) galvanized steel x 30 ft. long
- Conduit hanging clip is 3/4" wide x 1-5/8" long and is made of spring steel with zinc plate
- Round support tube is rigid 3/4" EMT conduit (.922" O.D.) x .049" metal wall thickness, painted white
- 10 ft. support tube requires an additional cable assembly hanging point located in the middle
- Other cable and support tube lengths and colors available – please inquire

ITEM #	OVERALL LENGTH	COMPONENT TYPE	NUMBER OF CABLE ASSEMBLIES REQUIRED	FINISH	SAFE WORKING LOAD LIMIT
220191	4 ft.	Support Tube	2	White	16 lbs.
220193	6 ft.	Support Tube	2	White	16 lbs.
220197	10 ft.	Support Tube	3	White	16 lbs.
105130	30 ft.	Cable Assembly	n/a	Zinc	16 lbs.

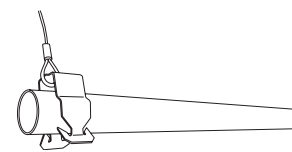

360 Degree Trapeze Banner Hanger Adapter Kit

Ingenious flush mount trapeze adapter that can be used to place, support and pivot our Adjustable Trapeze Banner Hanger System (sold separately) from exposed metal overhead fixtures or supports. Unlike our stationary adjustable trapeze, this hanger turns a full 360 degrees, thus allowing signs to be faced at optimal viewing angles. Two-piece, strong pivoting "U" track design with integrated slotted holes that accept our mounting hose clamps (included) on the top and our trapeze system cable assemblies (sold separately) on the bottom. Simply attach the top side directly to an exposed solid or split beam open style warehouse ceiling support with the included hose clamps and then pass the cables from our Adjustable Trapeze Banner Hanger System through the bottom holes – it's that easy!

Warning: Hose clamps must be firmly fastened and locked to the overhead fixture or support. Use only in dry, indoor locations.

- 1-5/8" wide x 1-5/8" height joined pivoting "U" track assembly
- Three 3/16" height x 5/8" long slotted holes on each "U" track
- Two 1/2" wide x 1-3/4" through 7-3/4" diameter grip range stainless steel mounting hose clamps included with an instruction sheet
- Slotted screwdriver for hose clamps required (sold separately – see page 291)
- .060" metal wall thickness painted white

ITEM #	OVERALL LENGTH	NUMBER OF HOLES	SAFE WORKING LOAD LIMIT *
220033	18"	3 per track	16 lbs.

* Includes the weight of the trapeze banner hanger system being used

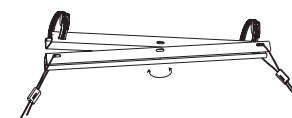

Ladderless Mounting Strip

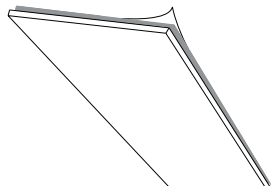

Are you looking to hang signs from window frames/sills that are not magnetically receptive, such as frames made of finished wood, vinyl or aluminum? If so, we have the solution! This inexpensive, adhesive-backed steel strip attracts magnets and can be used with our line of ladderless magnetic banner hangers. Simply peel and stick to almost any clean, flat surface. Can also be attached to existing magnetic window frame strips for added strength. Use multiple strips to create unlimited lengths. **Warning:** Do not attach directly to glass, as glass could break during use.

- For use on front face or underside of the top of indoor window frames
- Not recommended for outdoor use
- Black acrylic based adhesive-backed liner
- Custom lengths and colors available – please inquire
- .024" thick white painted steel

ITEM #	OVERALL LENGTH	WIDTH
220121	26"	1"
220122	36"	1"
220123	48"	1"

Plastic Banner Dowel Rod

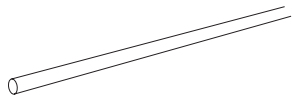

Use to economically display sewn/hemmed fabric or vinyl banners. Simply slide this round rigid plastic dowel into the sleeve of an edge sewn graphic and then into the inside track of our Ladderless Magnetic "C" Channel Banner Hanger (page 279). Also works great with our Elliptical Aluminum Hanger, our Round and Square Plastic Hangers, and our Vinyl Graphic Banner Hanger Tracks (all sold separately). Unlike wooden dowels, plastic dowels are extruded smooth with no chance of splinters. For longer lengths, use two or more dowels end to end.

- 1/4" diameter solid rigid dowel
- Use with end caps (sold separately) for a clean, finished appearance
- Dowels are always produced 1/8" shorter than below stated lengths to assure a proper fit
- Custom lengths available – please inquire
- White acrylic material

ITEM #	LENGTH	DIAMETER	COLOR
220201	24"	1/4"	White
220202	26"	1/4"	White
220203	36"	1/4"	White
220200	48"	1/4"	White

Ladderless "C" Channel Clip & Cord

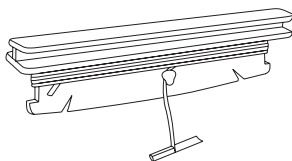

A friction fit version of our highly popular Ceiling Twist Clip & Cord. Used to suspend signs, mobiles, banners and seasonal decorations directly from the track of our full line of Ladderless Magnetic and Ladderless Hook Banner Hangers that have an integrated bottom "C" channel. Two styles to choose from: a lightweight standard duty or a stronger heavy duty option. Unravel wound barbed cord to desired length. Built-in slits allow for micro-adjustments of cord lengths for even hanging.

Patented.

- The standard style clip is 3" long x 3/4" overall height with a light duty cord and a 5/8" long metal barb
- The heavy duty style clip is 4" long x 1" overall height with a heavy duty cord and a 7/8" long metal barb
- Clip is white styrene material
- Also available with black cord – please inquire
- Packaged 50 per bag

ITEM #	CORD LENGTH	CORD COLOR	CORD MATERIAL	STYLE	SAFE WORKING LOAD LIMIT *
220080	10 ft.	White	Braided Polyester	Standard	2 lbs.
220080C	10 ft.	Clear	Monofilament	Standard	2 lbs.
220085	10 ft.	White	Braided Polyester	Heavy Duty	4 lbs.

* Safe working load limit is based on a single banner hanger having a minimum of two sign hanging points

Ladderless End Cap Retainer

Friction fits directly onto the neck area of our line of ladderless magnetic and hook banner hangers, as well as our Vinyl Graphic Banner Hanger Tracks, that have an integrated bottom “C” channel. Provides a decorative end “stop” that helps retain hanging hardware, adapters or spiral signs/pads within the “C” channel bottom track.

- 7/8" height x 1/2" width
- External legs are 3/4" long
- Textured face
- Rectangular shape
- White polycarbonate material

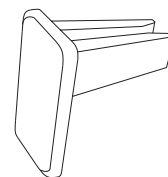

ITEM #	FOR USE WITH
220005W	Ladderless Sign Hanging Tracks

Ladderless Multi-Use Hanger Clip

Slides directly into the bottom track of our line of ladderless magnetic and ladderless hook banner hangers that have an integrated bottom “C” channel and provides an adjustable hanging point. Works in conjunction with our family of plastic and metal double “C” hooks, locking hooks, rings and clips (all sold separately). **Warning:** Not recommended for use with barbed cords unless the cord is tied through the center hole.

- 5/8" height x 5/8" width
- 13/64" diameter teardrop shaped hole
- Clear polycarbonate material
- Packaged 100 per bag

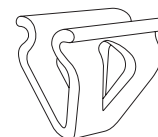

ITEM #	FOR USE WITH
220100	Ladderless Sign Hanging Tracks

Ladderless Block End Hooks

Slides directly into the bottom track of our line of ladderless magnetic and ladderless hook banner hangers that have an integrated bottom “C” channel. Fixed length clear plastic open end hook that hangs signs level. Integrated block end hole allows hooks to be linked together for multiple lengths.

- 5/32" diameter
- 1/4" shepherd shaped hook opening on one end
- Minimum recommended panel hole size is 13/64"
- Clear polycarbonate material
- Packaged 50 per bundle



ITEM #	OVERALL LENGTH	FOR USE WITH
220250	4-1/4"	Ladderless Sign Hanging Tracks
220252	12"	Ladderless Sign Hanging Tracks
220251	16"	Ladderless Sign Hanging Tracks



Hooks can be “laddered” onto each other for extended lengths

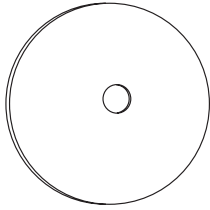

Ladderless Mounting Plates

Are you looking to magnetically hang signs from ceilings, walls or perimeter soffits, but do not have ceiling grids or other exposed metal fixtures/supports? If so, we have the solution! This inexpensive round disk creates a magnetically-receptive surface almost anywhere. For use on ceilings or walls, and can be used with our full line of ladderless magnetic banner hangers. When combined with our Ladderless Toggle Screw Mounting Plate Anchor or Mounting Plate Stud Screw (sold separately), these metal plates are great for use on drywall, wallboard, wood, paneling, plaster, block and other hollow base materials. **Patented.**

- Use one plate at 11 inches on center for each banner hanger magnet (not for use with our #220517 Heavy Duty Hanger)
- For use on both ceilings and walls
- Additional colors and finishes available – please inquire
- .033" thick zinc plated (silver) or white painted steel

ITEM #	I.D.	O.D.	FINISH
220115	9/16"	4"	Zinc Plate
220115W	9/16"	4"	White

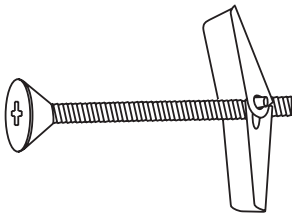

Ladderless Toggle Screw Mounting Plate Anchor

Two-piece, heavy duty anchor for extra holding power, used in conjunction with our Ladderless Mounting Plates (sold separately). Great for use in ceilings, walls or perimeter soffits made of plaster, paneling, drywall, block or other types of hollow wall materials. Pre-drilling of holes is required. Simply put the screw through the mounting plate, thread toggle wing onto screw, fold wings back, insert anchor through pre-drilled hole until wings spring open and then firmly tighten screw.

- Toggle wings are 10-24 (3/16") x 2-1/8" overall length
- Screw has a flush, low profile Phillips countersunk head
- Hole drill size is 1/2" (drill bit sold separately – see page 291)
- Both screws and toggle wings are zinc plated (silver) steel
- Parts come unassembled
- Other colors available – please inquire
- Packaged 50 screws and 50 toggle wings per bag

ITEM #	SCREW DIAMETER	SCREW LENGTH	SCREW HEAD FINISH
220114	10-24 (3/16")	3"	Zinc Plate
220114W	10-24 (3/16")	3"	White

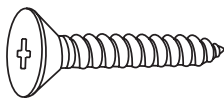

Ladderless Mounting Plate Stud Screw

One-piece, coarse thread screw anchor for use in conjunction with our Ladderless Mounting Plates (sold separately). Features a sharp point that engages right into wood studs to create a strong hold. Use in place of our two-piece toggle screw mounting plate anchor for instances when hollow walls or hollow ceilings are not available. Include in hardware kits as an anchoring option for when wood studs may be encountered. Pre-drilling of holes is required. Simply insert the screw through the mounting plate and screw flush into wood studs or solid wood surfaces – it's that easy. **Warning:** Not designed for use on metal studs or in hollow wall materials (such as wallboard or drywall) unless wood studs are directly encountered.

- Screw has a flush countersunk head with a Phillips drive
- Hole drill size is 7/32" (drill bit sold separately – see page 291)
- Zinc plated steel material

ITEM #	SCREW DIAMETER	SCREW LENGTH	SCREW HEAD FINISH
220112	#14	1-3/4"	Zinc Plate
220112W	#14	1-3/4"	White

Ladderless Mounting Plate Hardware Kits

Everything you need to make most any ceiling or wall surface magnetically receptive for our full line of Ladderless Magnetic Banner Hangers. Included in each clear polybagged kit are round mounting plates, toggle screw anchors, stud screws and an easy to follow instruction sheet. Works with both hollow walls/ceilings or wood studs to create a strong hold. Pre-drilling of holes is required. Simply select a magnetic banner hanger and determine the number of magnets to then select which kit is required – it's that easy. **Patented.**

- Hole drill size is 7/32" for wood studs and 1/2" for hollow walls/ceilings (drill bits sold separately – see below)
- Use one plate at 11 inches on center for each banner hanger magnet (not for use with our #220517 Heavy Duty Hanger)
- Screws have a flush, low profile Phillips countersunk head
- Plates are .033" thick x 4" O.D. – zinc plated steel
- Toggle screw anchors are 10-24 (3/16") x 3" overall length – zinc plated steel
- Stud screws are #14 x 1-3/4" overall length – zinc plated steel
- Available in zinc plate (silver) or painted white
- Other colors available – please inquire

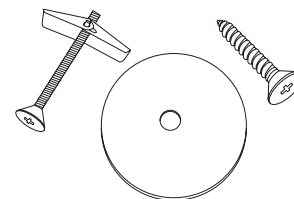

ITEM #	CONTENTS	FINISH
220151	One Round Plate, One Toggle Screw Anchor and One Stud Screw	Zinc Plate
220151W	One Round Plate, One Toggle Screw Anchor and One Stud Screw	White
220152	Two Round Plates, Two Toggle Screw Anchors and Two Stud Screws	Zinc Plate
220152W	Two Round Plates, Two Toggle Screw Anchors and Two Stud Screws	White
220153	Three Round Plates, Three Toggle Screw Anchors and Three Stud Screws	Zinc Plate
220153W	Three Round Plates, Three Toggle Screw Anchors and Three Stud Screws	White
220154	Four Round Plates, Four Toggle Screw Anchors and Four Stud Screws	Zinc Plate
220154W	Four Round Plates, Four Toggle Screw Anchors and Four Stud Screws	White
220155	Five Round Plates, Five Toggle Screw Anchors and Five Stud Screws	Zinc Plate
220155W	Five Round Plates, Five Toggle Screw Anchors and Five Stud Screws	White

Ladderless Drill Bits

Economical, general purpose jobbers' drill bits. High speed steel combined with maximum reach, drilling depth and rigidity make these bits ideal for use with our line of Ladderless Toggle Screw Mounting Plate Anchors and Stud Screws (sold separately). Not recommended for use in hard/solid materials such as brick, block or concrete.

- Include these drill bits in hardware kits
- Rigid, full straight shank
- 118 degree point angle
- High speed steel with black oxide finish



ITEM #	DRILL BIT SIZE	OVERALL LENGTH
220175	7/32" dia.	3-3/4"
220176	1/2" dia.	6"

Economy Screwdrivers

Our most economical screwdrivers. Include these in hardware kits. Large, comfortable plastic handles offer a secure grip and solid turning power.

- #2 Phillips drive fits most screws 5-40 through 10-24 diameter
- #3 Phillips drive fits most screws 12-24 through 1/4-20 diameter
- 1/4" Slotted is the width of the tip of the blade
- Handles are 1" O.D. black polypropylene material
- Round blades are 15/64" dia. heat treated steel
- Items below have Phillips or Slotted drive blades – also available with Torx or Square drive blades

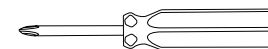

Phillips



Slotted

ITEM #	BLADE DRIVE	OVERALL LENGTH	HANDLE LENGTH	BLADE LENGTH
105075	#2 Phillips	3"	1-3/4"	1-1/4"
105085	1/4" Slotted	3"	1-3/4"	1-1/4"
105076	#2 Phillips	4"	1-3/4"	2-1/4"
105086	1/4" Slotted	4"	1-3/4"	2-1/4"
105077	#2 Phillips	6"	3-3/4"	2-1/4"
105087	1/4" Slotted	6"	3-3/4"	2-1/4"
105078	#3 Phillips	6"	3-3/4"	2-1/4"



siffron™ Item #	Kinter Item #	Match Type	Page #	siffron™ Item #	Kinter Item #	Match Type	Page #
0110869801	106603	Close Comparable	101	0402153809	108760	Comparable	127
0110869802	106604	Close Comparable	101	0402183307	108800	Comparable	29
0111705702	108639	Comparable	123	0402472900	150160	Comparable	126
0112460501	108638	Comparable	123	0402589032	108561	Comparable	32
0112460502	108639	Comparable	123	0403085930	108559	Comparable	32
0112460511	108639	Close Comparable	123	0404095997	108807	Comparable	32
0112465201	106601	Close Comparable	101	0404425386	150160	Close Comparable	126
0112465202	106602	Close Comparable	101	0406722608	150123	Comparable	126
0117633601	108637	Comparable	123	0407440837	108674	Comparable	32
0118113101	108638	Comparable	123	0408314900	150161	Comparable	126
0118113102	108639	Comparable	123	0409403383	150164	Close Comparable	126
0118163302	108683	Comparable	123	0502533101	107125	Close Comparable	130
0210000000	116621	Comparable	101	0507475901	107125	Comparable	130
0210000001	116622	Comparable	101	0507475902	107125	Close Comparable	130
0210000100	116623	Comparable	101	0507475917	107125	Close Comparable	130
0210000101	116624	Comparable	101	0507531601	107125	Close Comparable	130
0210950701	108106	Comparable	130	0507531602	107125	Close Comparable	130
0212006001	108549	Comparable	128	0601277701	107124	Comparable	124
0212006002	108549	Comparable	128	0601767800	108726	Close Comparable	124
0212045101	108100	Comparable	130	0604020201	107171	Comparable	31
0212045117	108100	Close Comparable	130	0604652201	116600	Comparable	21, 109
0212045170	108813	Close Comparable	130	0606780802	107181	Comparable	125
0212483001	108102	Comparable	131	0607615101	107170	Comparable	31
0213327600	108101	Comparable	131	1111431200	108665	Comparable	137
0214216701	108503	Comparable	121	1111431202	108521	Comparable	137
0217932002	108104	Comparable	129	1112148301	108522	Comparable	137
0222247301	107202	Comparable	123	1112148303	108529	Comparable	137
0226158201	107200	Comparable	129	1115110201	108719	Comparable	138
0226279701	107203	Comparable	121	1117574701	108105	Comparable	137
0227963601	107201	Comparable	129	1117653603	108897	Comparable	138
0227963608	107209	Comparable	129	1118108102	108676	Comparable	136
0302215000	107130	Comparable	134	1118108103	108677	Comparable	136
0302215002	107131	Comparable	134	1220643201	107213	Comparable	43
0302376301	140400	Comparable	135	1222025401	107205	Comparable	42
0302376302	140401	Comparable	135	1222025402	107205W	Comparable	42
0304002701	140501	Comparable	135	1222025404	107204	Comparable	42
0307927501	140402	Comparable	135	1222025421	107205	Close Comparable	42
0307927503	140403	Comparable	135	1225992001	109513	Comparable	42
0400542202	150153	Close Comparable	127	1226279701	107208	Comparable	136
0401448666	150164	Close Comparable	126	1227087100	107207	Comparable	42
0402153802	140701	Close Comparable	127	1227087101	107212	Comparable	42

Questions regarding close comparables? Contact us for details/samples.

If you do not see a Kinter match for what you are looking for, please contact our Sales Department for a prompt quotation.

* Kinter's (K International, Inc.'s) parts are not manufactured by or connected in any way with siffron™.

“Comparable” is defined as “may not be identical to the siffron part, but generally corresponds to the siffron part and is suitable for the customer’s intended use.”

“Close Comparable” is defined as “generally corresponds to the siffron part and is suitable for the customer’s intended use, but may be slightly different in dimensions, aesthetics, materials or function.”

siffron™ Item #	Kinter Item #	Match Type	Page #	siffron™ Item #	Kinter Item #	Match Type	Page #
1227087110	107207	Close Comparable	42	1503933901	108682	Comparable	33
1227087111	107212	Close Comparable	42	1503933902	108681	Comparable	33
1228016701	107206	Comparable	42	1503933903	108592	Comparable	33
1228016702	107206W	Comparable	42	1503933940	108682	Close Comparable	33
1228016707	107206	Close Comparable	42	1503933941	108681	Close Comparable	33
1301794700	108869	Close Comparable	44	1504545400	109522B	Comparable	191
1302104202	108686	Comparable	44	1504545401	109522	Comparable	191
1303709401	108869	Comparable	44	1504545406	109523	Comparable	191
1307502703	108698	Comparable	44	1505132710	108866	Comparable	132
1307636603	108685	Comparable	44	1506280001	108737	Comparable	145
1401756800	107216	Comparable	43	1506584201	116230	Comparable	24, 112
1401981700	107217	Close Comparable	43	1507020629	150061	Comparable	170
1402503800	107217	Comparable	43	1507053532	150050	Comparable	171
1402597601	108562	Comparable	139	1507782200	108505	Comparable	139
1407594602	108706	Comparable	41	1507965500	108506	Comparable	139
1407594604	108707	Comparable	41	1508076000	107106	Comparable	145
1407594605	108708	Comparable	41	1508563201	106905	Comparable	105
1407641500	107215	Comparable	43	1508648200	107120	Comparable	191
1408084901	150051	Comparable	170	1508728800	107225	Comparable	128
1408805001	150367	Comparable	10, 31	1509587601	116400	Comparable	21, 108
1500546301	150325	Comparable	140	1510635701	108714-4	Close Comparable	Call for details
1500546302	150325B	Comparable	140	1510635702	108714-8	Close Comparable	Call for details
1500546303	130623	Comparable	159	1510635703	108714-12	Close Comparable	Call for details
1500702402	200030B	Comparable	16, 66	1510635704	108714-16	Close Comparable	Call for details
1500702403	200033B	Comparable	16, 66	1510635706	108714B-4	Close Comparable	Call for details
1500702408	200032B	Comparable	16, 66	1510635708	108714B-8	Close Comparable	Call for details
1500928463	150054	Comparable	171	1510635709	108714B-12	Close Comparable	Call for details
1501932101	108546	Comparable	32	1510635710	108714B-16	Close Comparable	Call for details
1501949900	108501	Comparable	140	1510635712	108714W-4	Close Comparable	Call for details
1502440001	150162	Comparable	128	1510635713	108714W-8	Close Comparable	Call for details
1502440002	150162	Close Comparable	128	1510635714	108714W-12	Close Comparable	Call for details
1502440041	150162	Close Comparable	128	1510635715	108714W-16	Close Comparable	Call for details
1502544101	106906	Comparable	105	1511031801	108605	Comparable	193
1502984101	140230	Comparable	221	1511031802	108606	Comparable	193
1502984102	140231	Comparable	221	1511031803	108607	Comparable	193
1503210001	116910	Comparable	22, 110	1511223401	108728	Comparable	118
1503210002	116700	Comparable	22, 110	1512474701	106310 + 106311	Comparable	97
1503322301	118729	Comparable	146	1512474702	106313 + 106314	Comparable	97
1503322302	118729	Comparable	146	1512474703	106316 + 106317	Comparable	97
1503327802	109524B	Comparable	191	1512474704	106319 + 106320	Comparable	97
1503327851	109525	Comparable	191	1512474706	106310B + 106311B	Comparable	97

Questions regarding close comparables? Contact us for details/samples.

If you do not see a Kinter match for what you are looking for, please contact our Sales Department for a prompt quotation.

* Kinter's (K International, Inc.'s) parts are not manufactured by or connected in any way with siffron™.

"Comparable" is defined as "may not be identical to the siffron part, but generally corresponds to the siffron part and is suitable for the customer's intended use."

"Close Comparable" is defined as "generally corresponds to the siffron part and is suitable for the customer's intended use, but may be slightly different in dimensions, aesthetics, materials or function."



siffron™ Item #	Kinter Item #	Match Type	Page #	siffron™ Item #	Kinter Item #	Match Type	Page #
1512474708	106313B + 106314B	Comparable	97	1516419501	116106	Comparable	20, 108
1512474709	106316B + 106317B	Comparable	97	1516420001	116109	Comparable	20, 108
1512474710	106319B + 106320B	Comparable	97	1519250601	106312	Close Comparable	97
1512474712	106310W + 106311W	Comparable	97	1519250602	106315	Close Comparable	97
1512474713	106313W + 106314W	Comparable	97	1519250603	106318	Close Comparable	97
1512474714	106316W + 106317W	Comparable	97	1519250604	106321	Close Comparable	97
1512474715	106319W + 106320W	Comparable	97	1519250606	106312B	Close Comparable	97
1513283401	106210 + 106211	Comparable	97	1519250608	106315B	Close Comparable	97
1513283402	106213 + 106214	Comparable	97	1519250609	106318B	Close Comparable	97
1513283403	106216 + 106217	Comparable	97	1519250610	106321B	Close Comparable	97
1513283404	106219 + 106220	Comparable	97	1519250612	106312W	Close Comparable	97
1513283406	106210B + 106211B	Comparable	97	1519250613	106315W	Close Comparable	97
1513283408	106213B + 106214B	Comparable	97	1519250614	106318W	Close Comparable	97
1513283409	106216B + 106217B	Comparable	97	1519250615	106321W	Close Comparable	97
1513283410	106219B + 106220B	Comparable	97	1519465501	106212	Close Comparable	97
1513283412	106210W + 106211W	Comparable	97	1519465502	106215	Close Comparable	97
1513283413	106213W + 106214W	Comparable	97	1519465503	106218	Close Comparable	97
1513283414	106216W + 106217W	Comparable	97	1519465504	106221	Close Comparable	97
1513283415	106219W + 106220W	Comparable	97	1519465506	106212B	Close Comparable	97
1514519402	108730	Comparable	206	1519465508	106215B	Close Comparable	97
1514844301	116103	Comparable	20, 108	1519465509	106218B	Close Comparable	97
1514868701	106303	Comparable	106	1519465510	106221B	Close Comparable	97
1514868702	106304	Comparable	106	1519465512	106212W	Close Comparable	97
1515175701	116300	Comparable	24, 112	1519465513	106215W	Close Comparable	97
1515488801	106301	Comparable	106	1519465514	106218W	Close Comparable	97
1515488802	106302	Comparable	106	1519465515	106221W	Close Comparable	97
1516034301	116104	Comparable	20, 108	1601799801	101027	Comparable	233
1516080901	106306	Comparable	20, 106	1601799802	101027C	Comparable	233
1516080902	106309	Comparable	20, 106	1602487101	101002	Comparable	232
1516358001	108715-4	Close Comparable	Call for details	1602487102	101004	Comparable	232
1516358002	108715-8	Close Comparable	Call for details	1602487103	101003	Comparable	232
1516358003	108715-12	Close Comparable	Call for details	1602487131	101005	Comparable	232
1516358004	108715-16	Close Comparable	Call for details	1603373201	101007	Comparable	232
1516358006	108715B-4	Close Comparable	Call for details	1603373202	101005	Comparable	232
1516358008	108715B-8	Close Comparable	Call for details	1607699403	101026	Comparable	233
1516358009	108715B-12	Close Comparable	Call for details	1607699406	101026C	Comparable	233
1516358010	108715B-16	Close Comparable	Call for details	1607781101	101025	Comparable	233
1516358012	108715W-4	Close Comparable	Call for details	1607781103	101025C	Comparable	233
1516358013	108715W-8	Close Comparable	Call for details	1608158202	101028	Comparable	234
1516358014	108715W-12	Close Comparable	Call for details	1608158205	101028C	Comparable	234
1516358015	108715W-16	Close Comparable	Call for details	1608772910	130565	Comparable	203

Questions regarding close comparables? Contact us for details/samples.

If you do not see a Kinter match for what you are looking for, please contact our Sales Department for a prompt quotation.

* Kinter's (K International, Inc.'s) parts are not manufactured by or connected in any way with siffron™.

“Comparable” is defined as “may not be identical to the siffron part, but generally corresponds to the siffron part and is suitable for the customer's intended use.”

“Close Comparable” is defined as “generally corresponds to the siffron part and is suitable for the customer's intended use, but may be slightly different in dimensions, aesthetics, materials or function.”

siffron™ Item #	Kinter Item #	Match Type	Page #	siffron™ Item #	Kinter Item #	Match Type	Page #
1701722301	130553	Comparable	203	1813612402	106972	Comparable	102
1701722302	130555	Comparable	203	1813612411	106971	Close Comparable	102
1701722303	130559	Comparable	203	1813612412	106972	Close Comparable	102
1701804500	130500B	Comparable	202	1813721601	106701	Comparable	103
1701804501	130500	Comparable	202	1813721602	106702	Comparable	103
1701804502	130570	Comparable	203	1813962700	150042	Comparable	36
1701804503	130504	Comparable	202	1814790800	108107	Comparable	133
1701804505	130571	Comparable	203	1815245601	106703	Comparable	103
1701804512	130504B	Comparable	202	1815245602	106704	Comparable	103
1701804514	130514	Comparable	202	1815260001	106943	Comparable	104
1701804554	130514B	Comparable	202	1815260002	106944	Comparable	104
1701804562	130510	Comparable	202	1816180600	116970	Comparable	22, 109
1701804563	130510B	Comparable	202	1816180610	116970B	Comparable	22, 109
1702520101	130560	Comparable	203	1816255300	116960	Close Comparable	22, 110
1702520102	130561	Comparable	203	1816255301	106961	Close Comparable	102
1702520103	130562	Comparable	203	1816255302	106962	Close Comparable	102
1702520104	130563	Comparable	203	1816255304	116960B	Close Comparable	22, 110
1704636900	130506	Comparable	202	1816255305	106961B	Close Comparable	102
1704636901	130506B	Comparable	202	1816255306	106962B	Close Comparable	102
1707955602	130512	Comparable	202	1816255308	106961	Close Comparable	102
1707955603	130513	Comparable	202	1816286501	108582	Comparable	148
1707955604	130513	Close Comparable	202	1816456801	108564	Comparable	148
1810000000	108787	Comparable	120	1816579501	116101	Comparable	20, 108
1810080800	108653	Comparable	118	1816579507	116101-4	Comparable	Call for details
1810344001	108794	Comparable	119	1816580001	116102	Comparable	20, 108
1810514901	106803	Comparable	100	1816580007	116102-4	Comparable	Call for details
1810514902	106804	Comparable	100	1816686801	106931	Close Comparable	100
1810784501	106911	Comparable	103	1816686802	106932	Close Comparable	100
1810784502	106912	Comparable	103	1816686803	106933	Close Comparable	100
1811600901	108563	Comparable	148	1816686804	106934	Close Comparable	100
1811876800	108756	Comparable	133	1816988401	108109	Comparable	133
1811888801	108579	Comparable	133	1817099701	108108	Comparable	119
1812208702	108667	Comparable	121	1817469400	108721	Comparable	36
1812524300	106930	Close Comparable	21, 109	1817603600	106941	Comparable	104
1812964901	106971	Comparable	102	1817603601	106942	Comparable	104
1812964902	106972	Comparable	102	1817603602	116940	Comparable	23, 110
1812964904	106968 + 150180	Close Comparable	184 + 181	1817663001	106401	Comparable	100
1812964911	106971B	Comparable	102	1817663003	106402	Comparable	100
1812964912	106972B	Comparable	102	1818429901	106403	Comparable	100
1813488701	108110	Comparable	119	1818429902	106404	Comparable	100
1813612401	106971	Comparable	102	1818437801	108753	Comparable	119

Questions regarding close comparables? Contact us for details/samples.

If you do not see a Kinter match for what you are looking for, please contact our Sales Department for a prompt quotation.

* Kinter's (K International, Inc.'s) parts are not manufactured by or connected in any way with siffron™.

"Comparable" is defined as "may not be identical to the siffron part, but generally corresponds to the siffron part and is suitable for the customer's intended use."

"Close Comparable" is defined as "generally corresponds to the siffron part and is suitable for the customer's intended use, but may be slightly different in dimensions, aesthetics, materials or function."



siffron™ Item #	Kinter Item #	Match Type	Page #	siffron™ Item #	Kinter Item #	Match Type	Page #
1818734801	108754	Comparable	119	2112381809	108517	Comparable	122
1818823101	108699	Comparable	120	2112381817	108618	Comparable	122
1853492863	140670	Close Comparable	114	2112381901	107090	Comparable	117
2007299201	106022	Close Comparable	98	2112381902	107091	Comparable	117
2007299202	106022B	Close Comparable	98	2112381903	107079	Comparable	117
2007299203	106022	Close Comparable	98	2112624101	108520	Comparable	115
2007299207	106022	Comparable	98	2112624102	107092	Comparable	116
2007299208	106022B	Comparable	98	2112624105	108751	Comparable	115
2007299209	106022	Close Comparable	98	2112624137	108539	Comparable	115
2007585703	106025	Comparable	98	2112624160	108520	Close Comparable	115
2007585704	106025B	Comparable	98	2112624200	108551	Comparable	115
2007585707	106021	Comparable	99	2112624201	108752	Comparable	115
2007585708	106021B	Comparable	99	2112624202	108552	Comparable	115
2007585709	106020	Comparable	98	2112624260	108551	Close Comparable	115
2007585710	106020B	Comparable	98	2112735402	116200	Comparable	24, 112
2007585760	106025	Close Comparable	98	2112873401	116460	Comparable	24, 111
2007647502	108507	Comparable	99	2113886701	108542	Comparable	122
2007647503	108508	Comparable	99	2113886703	108543	Comparable	122
2007647551	140707	Comparable	99	2113886706	108612	Comparable	122
2007647552	108508	Close Comparable	99	2114270801	106233	Comparable	107
2007818501	108513	Comparable	99	2114270802	106234	Comparable	107
2007818502	108514	Comparable	99	2114380801	108544	Comparable	118
2007818551	140708	Comparable	99	2114380860	108544	Close Comparable	118
2007818552	140709	Comparable	99	2114441600	116900	Close Comparable	23, 111
2110213701	106463	Comparable	106	2114441610	116990	Close Comparable	23, 111
2110213702	106464	Comparable	106	2114444400	116900	Comparable	23, 111
2110483901	108548	Comparable	114	2114444401	106901	Comparable	104
2110483902	108547	Comparable	114	2114444410	116990	Comparable	23, 111
2110705201	108553	Comparable	115	2114444421	106991	Comparable	104
2110705202	108554	Comparable	115	2114491101	106503	Comparable	106
2111109201	108632	Comparable	115	2114491102	106504	Comparable	106
2111898802	106201	Comparable	107	2115247901	106231	Comparable	107
2111898803	106202	Comparable	107	2115247902	106232	Comparable	107
2111909301	108775	Comparable	118	2115893801	116500	Comparable	23, 111
2111909302	108776	Comparable	118	2116004501	108555	Comparable	148
2111988901	106461	Comparable	106	2116004502	108556	Comparable	148
2111988902	106462	Comparable	106	2116126201	107093	Comparable	116
2112299302	130630	Comparable	161	2117342601	106501	Comparable	106
2112361502	130632	Comparable	161	2117342602	106502	Comparable	106
2112381802	108515	Comparable	122	2117385301	106923	Comparable	105
2112381804	108516	Comparable	122	2117548202	108523	Comparable	114

Questions regarding close comparables? Contact us for details/samples.

If you do not see a Kinter match for what you are looking for, please contact our Sales Department for a prompt quotation.

* Kinter's (K International, Inc.'s) parts are not manufactured by or connected in any way with siffron™.

“Comparable” is defined as “may not be identical to the siffron part, but generally corresponds to the siffron part and is suitable for the customer’s intended use.”

“Close Comparable” is defined as “generally corresponds to the siffron part and is suitable for the customer’s intended use, but may be slightly different in dimensions, aesthetics, materials or function.”

siffron™ Item #	Kinter Item #	Match Type	Page #	siffron™ Item #	Kinter Item #	Match Type	Page #
2117548204	108523R	Comparable	114	2162283901	108587	Close Comparable	166
2117548208	108524	Comparable	114, 239, 242, 245	2162283907	108586	Close Comparable	166
2117614101	108755	Comparable	166	2162283908	108586	Close Comparable	166
2117777700	116920	Comparable	23, 111	2162284001	108587	Comparable	166
2117777701	106921	Comparable	105	2162284002	108586	Comparable	166
2117951802	108527	Comparable	114	2162348701	107415	Comparable	87
2117951804	108528	Comparable	114	2162348702	107416	Comparable	87
2117966102	108525	Comparable	114	2162507001	107136	Comparable	166
2117966104	108525R	Comparable	114	2163273503	107405	Comparable	179
2117966106	108526	Comparable	114	2163273505	107406	Close Comparable	179
2117966108	108535	Comparable	114	2163273506	107406	Comparable	179
2117966113	107089	Comparable	116	2163380601	108893	Close Comparable	168
2117966151	107097	Comparable	117	2165828401	108893	Close Comparable	168
2117966152	107095	Comparable	116	2166395300	107135	Comparable	167
2117966187	108525	Close Comparable	114	2200872202	107411	Comparable	172
2117966194	108526	Close Comparable	114	2200872206	107410	Comparable	172
2117966195	108535	Close Comparable	114	2201588102	150803	Comparable	179
2117966207	107096	Comparable	116	2201588103	150808	Comparable	179
2117973011	108531	Comparable	114	2201737400	150822	Close Comparable	179
2117973012	108532	Comparable	114, 239, 242, 245	2201885102	109556	Comparable	177
2117973013	108533	Comparable	114	2201885104	150139	Close Comparable	178
2118171102	130631	Comparable	161	2202278001	150351	Comparable	172
2118171119	130621	Comparable	160	2202278005	150349	Comparable	172
2118389601	106203	Comparable	107	2202278010	150364	Comparable	172
2118389602	106204	Comparable	107	2202457202	150810	Close Comparable	177
2119164001	106903	Comparable	104	2202489800	150234	Comparable	179
2119164021	106993	Comparable	104	2202754101	150837	Close Comparable	179
2123992202	130617	Comparable	161	2202754105	150145	Comparable	178
2150580817	107712B	Close Comparable	150	2204737102	150143	Comparable	179
2151914191	107718B	Close Comparable	151	2300083206	130615	Comparable	163
2153660900	107711B	Close Comparable	150	2302453400	130602	Close Comparable	162
2153715599	106921	Comparable	105	2308042801	130603	Comparable	162
2154285141	106921B	Comparable	105	2308042802	130611	Comparable	162
2155152233	106903	Comparable	104	2308042803	130618	Close Comparable	163
2155586919	106903B	Comparable	104	2308042806	130618	Close Comparable	163
2157331293	107710B	Close Comparable	151	2308042807	130619	Comparable	163
2160827201	108536	Comparable	115	2308042841	130604	Comparable	162
2161534902	108633	Comparable	166	2308042842	130612	Comparable	162
2161534903	108634	Comparable	166	2308063301	130601	Comparable	162
2161722400	108691	Comparable	167	2407950101	140411	Close Comparable	134
				2407950102	140411	Comparable	134

Questions regarding close comparables? Contact us for details/samples.

If you do not see a Kinter match for what you are looking for, please contact our Sales Department for a prompt quotation.

* Kinter's (K International, Inc.'s) parts are not manufactured by or connected in any way with siffron™.

"Comparable" is defined as "may not be identical to the siffron part, but generally corresponds to the siffron part and is suitable for the customer's intended use."

"Close Comparable" is defined as "generally corresponds to the siffron part and is suitable for the customer's intended use, but may be slightly different in dimensions, aesthetics, materials or function."



siffron™ Item #	Kinter Item #	Match Type	Page #	siffron™ Item #	Kinter Item #	Match Type	Page #
2407950103	140412	Comparable	134	2806321301	150309	Comparable	157
2407950104	140413	Comparable	134	2806321302	150309	Close Comparable	157
2501648304	110050	Comparable	149	2806321303	150309	Close Comparable	157
2501648307	110051	Comparable	149	2806355301	150305	Comparable	156
2501687001	108500	Close Comparable	207	2806355304	150305	Close Comparable	156
2501687002	108500	Comparable	207	2806944501	150307	Comparable	158
2501807701	110027	Comparable	149	2807778501	150305	Close Comparable	156
2501807702	110028	Comparable	149	2807778502	150305	Close Comparable	156
2502089601	107111	Comparable	149	2807818801	150301	Comparable	154
2502089602	107112	Comparable	149	2807818806	150301	Close Comparable	154
2607620201	108566	Comparable	95	2809010601	150303	Comparable	156
2607620206	108567	Comparable	95	2809010612	150303	Close Comparable	156
2607620209	108568	Comparable	95	2809161001	150300	Comparable	157
2607620213	108569	Comparable	95	2809161007	150300	Close Comparable	157
2607620239	108569T	Comparable	95	2809254001	150304	Close Comparable	156
2800154701	150304	Comparable	156	2809254002	150304	Close Comparable	156
2800154716	150304	Close Comparable	156	3103425901	107408	Comparable	169
2800514429	150309	Comparable	157	3103425904	107409	Comparable	169
2801223401	150315	Comparable	154	3207532100	150062	Comparable	170
2801986042	108737	Comparable	145	3207604906	150056	Comparable	171
2802299993	150305	Close Comparable	156	3208034301	150052	Comparable	170
2803075913	150310	Comparable	157	3208034302	150052	Close Comparable	170
2803123601	150310	Comparable	157	3208497901	150055	Comparable	171
2803159501	150313	Comparable	158	3501655701	140718	Close Comparable	143
2803228301	150302	Close Comparable	154	3502445003	140660	Comparable	143
2803228302	150302	Close Comparable	154	3557919601	140620	Comparable	143
2804096101	150302	Comparable	154	3558043501	140700	Comparable	143
2804096111	150302	Close Comparable	154	3700000000	109505	Comparable	87
2804823501	150311	Comparable	155	3700306775	150280 + 150280B	Close Comparable	84
2804823502	150312	Comparable	155	3701014801	150238B	Comparable	85
2804823506	150311	Close Comparable	155	3701014802	150237B	Comparable	85
2804823507	150312	Close Comparable	155	3701096401	107068	Close Comparable	184
2804823509	150312	Close Comparable	155	3701096402	107068	Close Comparable	184
2804868644	150309	Close Comparable	157	3701134901	150225	Comparable	85
2804962601	150308	Close Comparable	158	3701134902	150226	Comparable	85
2804962609	150308	Close Comparable	158	3701134903	150227	Comparable	85
2805651002	150317	Close Comparable	155	3701134904	150228	Comparable	85
2805693105	150301	Close Comparable	154	3702346201	107087	Close Comparable	153
2805693108	150301	Close Comparable	154	3702346202	107087	Close Comparable	153
2805856583	107106	Comparable	145	3702358702	150200	Comparable	86
2806112901	150306	Comparable	159	3702512701	110026	Comparable	95

Questions regarding close comparables? Contact us for details/samples.

If you do not see a Kinter match for what you are looking for, please contact our Sales Department for a prompt quotation.

* Kinter's (K International, Inc.'s) parts are not manufactured by or connected in any way with siffron™.

“Comparable” is defined as “may not be identical to the siffron part, but generally corresponds to the siffron part and is suitable for the customer’s intended use.”

“Close Comparable” is defined as “generally corresponds to the siffron part and is suitable for the customer’s intended use, but may be slightly different in dimensions, aesthetics, materials or function.”

siffron™ Item #	Kinter Item #	Match Type	Page #	siffron™ Item #	Kinter Item #	Match Type	Page #
3702512702	110026B	Comparable	95	3708423816	150281	Comparable	84
3702512703	110026C	Comparable	95	3708679801	150285	Comparable	84
3703493301	150202B	Close Comparable	86	3708679802	150285B	Comparable	84
3703493302	150201B	Close Comparable	86	3709334303	150206B	Close Comparable	86
3703667401	107005	Comparable	96	3709480201K	150288B	Comparable	84
3703667402	107006	Comparable	96	3709480201R	150288 + 150288B	Close Comparable	84
3703667405	107007	Comparable	96	3709480201W	150288	Comparable	84
3703667411	107005B	Comparable	96	3709480207K	150289B	Comparable	84
3703667412	107006B	Comparable	96	3709480207R	150289 + 150289B	Close Comparable	84
3703667415	107007B	Comparable	96	3709480207W	150289	Comparable	84
3703667445	107007	Close Comparable	96	3709675379	150285 + 150285B	Close Comparable	84
3703667446	107007B	Close Comparable	96	3709675379R	150285 + 150285B	Close Comparable	84
3704079168	140990	Comparable	84	3800152600	108839	Comparable	92, 250
3704146885	140989	Comparable	84	3800301000	104203	Comparable	92
3704219339	140991	Comparable	84	3800301100	104204	Comparable	92
3704349395	140991B	Comparable	84	3800301200	104205	Comparable	92
3704398862	140989B	Comparable	84	3800501000	104215W	Comparable	92
3704707804	150179	Close Comparable	181	4100023691	140112	Comparable	67
3704707805	150179	Close Comparable	181	4100213468	150002	Comparable	67
3704707807	150182	Close Comparable	181	4100275660	140122	Comparable	67
3704707807K	150281B	Comparable	84	4100671807	150010	Comparable	67
3704707807R	150281 + 150281B	Close Comparable	84	4100816424	140115	Comparable	67
3704707807W	150281	Comparable	84	4100997240	150001	Comparable	67
3704707808	150182	Close Comparable	181	4100997972	150013	Comparable	67
3704707810	150183	Close Comparable	181	4101307634	140110	Comparable	67
3704707810K	150280B	Comparable	84	4101378107	150193	Close Comparable	69
3704707810R	150280 + 150280B	Close Comparable	84	4101378108	150193	Comparable	69
3704707810W	150280	Comparable	84	4101440051	140109	Comparable	67
3704707811	150183	Close Comparable	181	4101565579	140113	Comparable	67
3705275902K	150286B	Comparable	84	4101740040	140120	Comparable	67
3705275902R	150286 + 150286B	Close Comparable	84	4102623358	140117	Comparable	67
3705275902W	150286	Comparable	84	4102657533	150003	Comparable	67
3705373828	150281 + 150281B	Close Comparable	84	4102755031	150015	Comparable	67
3705812535	150280	Comparable	84	4103117401	150170	Comparable	70
3706128939	140990B	Comparable	84	4103117402	150171	Comparable	70
3706659565	150281B	Comparable	84	4103117403	150172	Comparable	70
3706769201K	150287B	Comparable	84	4103117404	150173	Comparable	70
3706769201R	150287 + 150287B	Close Comparable	84	4103117405	150174	Comparable	70
3706769201W	150287	Comparable	84	4103433728	140116	Comparable	67
3706774602	150280B	Comparable	84	4103548268	150005	Comparable	67
3707263573	140830	Close Comparable	84	4103716299	140118	Comparable	67

Questions regarding close comparables? Contact us for details/samples.

If you do not see a Kinter match for what you are looking for, please contact our Sales Department for a prompt quotation.

* Kinter's (K International, Inc.'s) parts are not manufactured by or connected in any way with siffron™.

"Comparable" is defined as "may not be identical to the siffron part, but generally corresponds to the siffron part and is suitable for the customer's intended use."

"Close Comparable" is defined as "generally corresponds to the siffron part and is suitable for the customer's intended use, but may be slightly different in dimensions, aesthetics, materials or function."



siffron™ Item #	Kinter Item #	Match Type	Page #	siffron™ Item #	Kinter Item #	Match Type	Page #
4103848001	140642	Comparable	70	4301810301	140962C	Comparable	12,40
4103848002	140884	Comparable	70	4301810302	150967C	Comparable	12, 40
4103954895	150000	Comparable	67	4301836501	108602	Close Comparable	94
4104112705	150007	Comparable	67	4301836502	108602W	Comparable	94
4104395487	150016	Comparable	67	4301836532	108602B	Close Comparable	94
4104475538	140121	Comparable	67	4301836533	108602B	Comparable	94
4105109259	140688	Comparable	67	4301836541	108602	Comparable	94
4105854001	108767	Comparable	69	4301836543	108602	Close Comparable	94
4106124308	140114	Comparable	67	4301836574	108602B	Close Comparable	94
4106402555	140111	Comparable	67	4301836575	108602	Close Comparable	94
4106447140	140119	Comparable	67	4301842501	140758B	Comparable	38
4106532217	150004	Comparable	67	4302590601	140900	Close Comparable	11, 37
4107233514	150011	Comparable	67	4302870801	108577	Comparable	93
4107282942	140689	Comparable	67	4302870802	108577B	Comparable	93
4107320103	150190	Close Comparable	69	4302870803	108574	Comparable	93
4107320303	150190	Comparable	69	4302870805	108575	Comparable	93
4107325003	150190	Close Comparable	69	4302870807	108576	Comparable	83
4107336996	150012	Comparable	67	4305867801	140940	Comparable	11, 37, 93
4107433123	150017	Comparable	67	4305867803	140940B	Comparable	11, 37, 93
4107698628	150014	Comparable	67	4306165713	108617	Comparable	35
4108610982	150006	Comparable	67	4306165724	108850B	Comparable	34
4130611504	150354	Close Comparable	17, 70	4306300302	108678	Comparable	30
4131750002	108668	Comparable	69	4307192801	140870B	Comparable	38
4131750003	108669	Comparable	69	4308048908	108690W	Comparable	37, 94
4136934803	108767	Close Comparable	69	4308048910	108690	Comparable	37, 94
4201124701	108743	Comparable	45	4308078201	108600	Close Comparable	94
4201674301	108593	Comparable	122	4308078202	108600W	Comparable	94
4203330900	108703	Comparable	32	4308078233	108600B	Comparable	94
4204212501	108807	Comparable	32	4308078241	108600	Comparable	94
4204220001	108559	Comparable	32	4308078251	108600B	Close Comparable	94
4204230001	108561	Comparable	32	4308078272	108600	Close Comparable	94
4204235001	108573	Comparable	32	4308078274	108600B	Close Comparable	94
4204240001	108674	Comparable	32	4308078275	108600T	Comparable	94
4301665601	108601	Close Comparable	94	4308183701	108631	Close Comparable	94
4301665602	108601W	Comparable	94	4308183702	108631W	Comparable	94
4301665633	108601B	Comparable	94	4308183733	108631B	Comparable	94
4301665641	108601	Comparable	94	4308183741	108631	Comparable	94
4301780119	108570W	Comparable	37, 94	4400116194	140717	Comparable	28
4301780121	108570	Comparable	37, 94	4400330364	140984W	Close Comparable	10, 33
4301780122	108570	Close Comparable	37, 94	4400483902	108656	Comparable	41
4301780133	108570B	Comparable	37, 94	4400483903	108657	Comparable	41

Questions regarding close comparables? Contact us for details/samples.

If you do not see a Kinter match for what you are looking for, please contact our Sales Department for a prompt quotation.

* Kinter's (K International, Inc.'s) parts are not manufactured by or connected in any way with siffron™.

"Comparable" is defined as "may not be identical to the siffron part, but generally corresponds to the siffron part and is suitable for the customer's intended use."

"Close Comparable" is defined as "generally corresponds to the siffron part and is suitable for the customer's intended use, but may be slightly different in dimensions, aesthetics, materials or function."

siffron™ Item #	Kinter Item #	Match Type	Page #	siffron™ Item #	Kinter Item #	Match Type	Page #
4400483909	108658	Comparable	41	4405830031	108675	Comparable	28
4400558501	108625W	Comparable	28	4406016854	108033	Comparable	44
4400558502	108761W	Comparable	28	4406331417	107164	Close Comparable	31
4400558509	108625	Close Comparable	28	4406366101	140960	Comparable	11, 36
4400669101	108608	Comparable	120	4407273224	108829	Comparable	44
4400862799	108779	Close Comparable	45	4407421101	108742	Comparable	45
4400897913	108779	Close Comparable	45	4407515844	105091	Comparable	224
4400936556	108835B	Comparable	35	4407547001	108697	Comparable	46
4401036701	108644	Comparable	28	4407569065	108857	Close Comparable	30
4401272900	108774W	Close Comparable	33	4407698801	108103	Comparable	131
4401418600	108696	Comparable	46	4407708621	108644	Comparable	44
4401434204	140984B	Comparable	10, 33	4408236064	105091	Close Comparable	224
4401434205	140984W	Comparable	10, 33	4408592202	108585W	Comparable	28
4401465812	108698	Comparable	44	4408649600	140984W	Close Comparable	10, 33
4401520633	108656	Comparable	41	4409019058	107170	Comparable	31
4401564459	108658	Comparable	41	4409612501	108680	Comparable	35
4401637900	108785W	Comparable	29	4409612502	108679	Comparable	35
4401637901	108785W	Close Comparable	29	4409663001	108817	Close Comparable	35
4401947401	108757W	Comparable	29	4414174901	108778	Close Comparable	28
4401947402	108757W	Close Comparable	29	4414174902	108778	Close Comparable	28
4401947405	108757W	Close Comparable	29	4414174904	108778	Close Comparable	28
4401947430	108757W	Close Comparable	29	4414185002	140732B	Comparable	30
4401955025	108849B	Comparable	34	4414201002	140732B	Close Comparable	30
4402420831	107168	Comparable	31	4415812002	108786	Comparable	46
4402719001	108695	Comparable	47	4415812003	108786	Close Comparable	46
4402719002	108827	Comparable	47	4416762901	108594	Close Comparable	128
4402967601	108594	Comparable	128	4420557906	109500	Close Comparable	47
4403470700	108625W	Close Comparable	28	4423336573	108810	Comparable	45
4403470701	108625	Close Comparable	28	4424398333	108742	Comparable	45
4403733901	108692W	Comparable	35	4424979856	109595	Comparable	47
4403757000	108621	Comparable	28	4425810395	140881	Comparable	47
4403911051	140984W	Close Comparable	10, 33	4425849180	109502	Comparable	47
4404144886	150968	Comparable	19, 82	4427878418	140681	Comparable	47
4404351634	108838	Comparable	41	4427936387	108743	Comparable	45
4405022908	140703	Comparable	68	4429788919	140737	Comparable	47
4405300067	108698	Close Comparable	44	4433032512	150252	Comparable	73
4405392830	108857	Close Comparable	30	4433561001	150253	Comparable	73
4405757101	140658W	Comparable	34	4622277226	200035B	Comparable	16, 66
4405757103	140658	Comparable	34	4622608030	200034B	Comparable	16, 66
4405820001	108626	Comparable	28	4654249342	109527	Comparable	63
4405830001	108675	Comparable	28	4629755786	200031B	Comparable	16, 66

Questions regarding close comparables? Contact us for details/samples.

If you do not see a Kinter match for what you are looking for, please contact our Sales Department for a prompt quotation.

* Kinter's (K International, Inc.'s) parts are not manufactured by or connected in any way with siffron™.

"Comparable" is defined as "may not be identical to the siffron part, but generally corresponds to the siffron part and is suitable for the customer's intended use."

"Close Comparable" is defined as "generally corresponds to the siffron part and is suitable for the customer's intended use, but may be slightly different in dimensions, aesthetics, materials or function."



siffron™ Item #	Kinter Item #	Match Type	Page #	siffron™ Item #	Kinter Item #	Match Type	Page #
4660856653	200016	Comparable	15, 64	6103657337	108015	Comparable	256
4662006232	200026	Comparable	14, 64	6103838801	110503	Close Comparable	236, 241
4666362921	200018	Comparable	15, 64	6103838802	110503W	Comparable	236, 241
4666739266	200020	Comparable	14, 64	6103838803	110503B	Comparable	236, 241
4667240540	200028	Comparable	14, 64	6103838804	110503	Comparable	236, 241
4667981757	109526B	Comparable	63	6104480547	104100	Comparable	262
4668084770	109526	Close Comparable	63	6104833787	108018	Comparable	256
4668658245	200010	Comparable	15, 64	6105112203	110506B	Comparable	237, 241
4668850249	109526	Comparable	63	6105112204	110506	Comparable	237, 241
4669585083	109626	Comparable	14, 63	6105973401	110502	Comparable	238, 240
5207512901	150220	Comparable	72	6105973402	110502B	Comparable	238-240
5207512902	150220	Close Comparable	72	6106300478	104003	Comparable	272
5207609301	150221	Comparable	72	6107632505	110825W	Comparable	246
5207609302	150221	Close Comparable	72	6107632506	110825	Comparable	246
5307734801	120458	Comparable	124	6107632507	110826	Comparable	246
5307734802	120459	Comparable	124	6107632508	110826W	Comparable	246
5307895101	120456	Comparable	124	6107632513	110827W	Comparable	246
5307895102	120457	Comparable	124	6107632514	110827	Comparable	246
5307895104	120455	Comparable	124	6107632519	110828W	Comparable	246
5307895124	120457	Comparable	124	6107632520	110828	Comparable	246
5652720617	150144	Comparable	179	6107796402	110600W	Comparable	236
5655818309	150166	Comparable	178	6107796407	110602W	Comparable	236
5656263534	150165	Close Comparable	178	6107796410	110603W	Comparable	236
5658206689	150801	Comparable	179	6107796411	110603B	Comparable	236
5659318513	150802	Comparable	179	6107932000	110507	Close Comparable	247
6100456311	107070	Comparable	96	6109120184	108021	Comparable	256
6100456312	107071	Comparable	96	6109504903	108011	Comparable	256
6100456315	107072	Comparable	96	6109637501	411211	Comparable	249
6100456316	107070B	Comparable	96	6109637502	411211	Close Comparable	249
6100456317	107071B	Comparable	96	6109662202	411230B	Close Comparable	249
6100456320	107072B	Comparable	96	6109662204	411231B	Close Comparable	249
6100622873	107025	Comparable	259	6109662601	411236	Comparable	249
6100897407	107025	Close Comparable	259	6109665001	411215	Comparable	249
6102095408	110804	Comparable	247	6109665002	411216	Comparable	249
6102095410	110805	Comparable	247	6109914024	108010	Comparable	256
6102095418	110806	Comparable	247	6110258402	110752	Comparable	239
6102095419	110806W	Comparable	247	6110258403	110753	Comparable	239
6102095423	110807	Comparable	247	6110258405	110751	Comparable	239
6102095424	110807W	Comparable	247	6110612101	110508C	Close Comparable	241
6102098704	108012	Comparable	256	6110612102	110508B	Comparable	241
6103041467	108014	Comparable	256	6110612105	110508	Comparable	241

Questions regarding close comparables? Contact us for details/samples.

If you do not see a Kinter match for what you are looking for, please contact our Sales Department for a prompt quotation.

* Kinter's (K International, Inc.'s) parts are not manufactured by or connected in any way with siffron™.

"Comparable" is defined as "may not be identical to the siffron part, but generally corresponds to the siffron part and is suitable for the customer's intended use."

"Close Comparable" is defined as "generally corresponds to the siffron part and is suitable for the customer's intended use, but may be slightly different in dimensions, aesthetics, materials or function."

siffron™ Item #	Kinter Item #	Match Type	Page #	siffron™ Item #	Kinter Item #	Match Type	Page #
6110612109	110508C	Comparable	241	6113768001	110500B	Comparable	238
6110624501	110770	Close Comparable	Call for details	6114197402	110024	Close Comparable	238
6110624502	110772	Close Comparable	Call for details	6114197403	110025	Close Comparable	238
6110624503	110773	Close Comparable	Call for details	6114197405	110023	Close Comparable	238
6110906600	110736	Comparable	96	6114791405	110024	Comparable	238
6110906601	110738	Comparable	96	6114791406	110025	Comparable	238
6112059101	110724	Comparable	95	6114791411	110023	Comparable	238
6112059102	110720	Comparable	95	6115686900	110746B	Comparable	241
6112059103	110722	Comparable	95	6115686902	110746B	Close Comparable	241
6112059104	110723	Comparable	95	6115686903	110747B	Close Comparable	241
6112059105	110721	Comparable	95	6115686904	110747B	Comparable	241
6112059107	110721B	Comparable	95	6115686905	110748B	Close Comparable	241
6112059108	110720B	Comparable	95	6115686906	110748B	Comparable	241
6112059109	110722B	Comparable	95	6115686909	110747C	Comparable	241
6112059110	110723B	Comparable	95	6115686911	110747	Comparable	241
6112125607	110811	Comparable	247	6115686912	110748	Comparable	241
6112125608	110813	Comparable	247	6115686919	110748C	Comparable	241
6112125609	110814	Comparable	247	6115686926	110746C	Comparable	241
6112125619	110814B	Comparable	247	6115686929	110746C	Close Comparable	241
6112125634	110812	Comparable	247	6115999200	110504B	Comparable	239
6112213901	110850	Comparable	246	6116252501	110740	Comparable	237
6112213902	110852	Comparable	246	6116252502	110740B	Comparable	237
6112213903	110853	Comparable	246	6116252505	110741	Comparable	237
6112213913	110853B	Comparable	246	6116252506	110741B	Comparable	237
6112213927	110851	Comparable	246	6116252509	110742	Comparable	237
6112562501	110700	Comparable	237	6116252510	110742B	Comparable	237
6112562502	110702	Comparable	237	6116252511	110742W	Comparable	237
6112562503	110703	Comparable	237	6116252513	110743	Comparable	237
6112562504	110700B	Comparable	237	6116252514	110743B	Comparable	237
6112562505	110702B	Comparable	237	6116252515	110743W	Comparable	237
6112562506	110703B	Comparable	237	6116324411	110790	Close Comparable	Call for details
6112562507	110701B	Comparable	237	6116324412	110791	Close Comparable	Call for details
6112562509	110701	Comparable	237	6116324413	110792	Close Comparable	Call for details
6112562513	110702W	Comparable	237	6118056601	110800	Comparable	236
6112562514	110703W	Comparable	237	6118056602	110802	Comparable	236
6113245301	110781	Close Comparable	Call for details	6118056603	110803	Comparable	236
6113245302	110782	Close Comparable	Call for details	6118056608	110801	Comparable	236
6113245303	110783	Close Comparable	Call for details	6118056613	110803	Close Comparable	236
6113327101	110808	Comparable	236	6118557401	110700	Close Comparable	237
6113327102	110809	Comparable	236	6118557402	110700B	Close Comparable	237
6113327103	110810	Comparable	236	6118557403	110701	Close Comparable	237

Questions regarding close comparables? Contact us for details/samples.

If you do not see a Kinter match for what you are looking for, please contact our Sales Department for a prompt quotation.

* Kinter's (K International, Inc.'s) parts are not manufactured by or connected in any way with siffron™.

"Comparable" is defined as "may not be identical to the siffron part, but generally corresponds to the siffron part and is suitable for the customer's intended use."

"Close Comparable" is defined as "generally corresponds to the siffron part and is suitable for the customer's intended use, but may be slightly different in dimensions, aesthetics, materials or function."



siffron™ Item #	Kinter Item #	Match Type	Page #	siffron™ Item #	Kinter Item #	Match Type	Page #
6118557404	110701B	Close Comparable	237	6132932010	107007B	Comparable	96
6118557405	110702	Close Comparable	237	6133102983	220481	Close Comparable	286
6118557406	110702B	Close Comparable	237	6133294707	220480	Close Comparable	286
6118557407	110703	Close Comparable	237	6133891262	110733	Comparable	246
6118557408	110703B	Close Comparable	237	6135335637	107007	Comparable	96
6118557502	110720	Close Comparable	95	6135585185	110732	Comparable	246
6118557503	110721	Close Comparable	95	6136253964	110722	Close Comparable	95
6118557504	110722	Close Comparable	95	6136602949	107006B	Comparable	96
6118557505	110723	Close Comparable	95	6137420271	110805	Close Comparable	247
6118557507	110720	Close Comparable	95	6137999967	107006	Comparable	96
6118557508	110721	Close Comparable	95	6139305666	110806	Close Comparable	247
6118557509	110722	Close Comparable	95	6139846612	110721	Close Comparable	95
6118557510	110723	Close Comparable	95	6139974092	110807	Close Comparable	247
6119686502	110746B	Close Comparable	241	6201916702	109543	Comparable	251
6119686504	110747B	Close Comparable	241	6201916707	109543	Close Comparable	251
6119686506	110748B	Close Comparable	241	6202153201	107060	Comparable	251
6119686509	110747C	Close Comparable	241	6202153202	107060	Close Comparable	251
6119686519	110748C	Close Comparable	241	6202153203	107060	Close Comparable	251
6119686529	110746C	Close Comparable	241	6207963901	107061	Comparable	251
6120030451	220121	Close Comparable	288	6207963902	107061	Close Comparable	251
6120178147	220022	Close Comparable	277	6207963904	109661	Comparable	251
6120227680	220537	Comparable	286	6208025401	107065	Comparable	251
6120329070	220508	Comparable	278	6208025403	107065	Close Comparable	251
6120391314	220122	Close Comparable	288	6301897101	220027	Comparable	264
6121129633	220122	Comparable	288	6302171000	220025	Comparable	264
6121714464	220121	Comparable	288	6400000100	104012	Comparable	273
6121774788	220251	Comparable	289	6400000101	104013	Comparable	273
6121942873	220509	Comparable	278	6400000300	104015	Comparable	273
6123401190	220024	Comparable	277	6400000301	104016	Comparable	273
6123771574	220533	Comparable	278	6400000500	104025	Comparable	273
6124780589	220100	Comparable	289	6400000501	104026	Comparable	273
6124948630	220024	Close Comparable	277	6400000600	104029	Comparable	273
6125827383	220121	Close Comparable	288	6400000601	104030	Comparable	273
6126156474	220122	Close Comparable	288	6400000602	104027	Comparable	273
6126430444	220536	Comparable	286	6400150850	107001	Comparable	263
6126649854	220507	Close Comparable	278	6400591901	107008	Comparable	264
6128037723	220532	Comparable	278	6400771602	107046	Close Comparable	253
6128141406	220024	Close Comparable	277	6400771612	107046	Close Comparable	253
6129638164	220250	Comparable	289	6400771622	107046	Close Comparable	253
6130270445	110731	Comparable	246	6400944311	220306	Comparable	256
6131712620	110723	Close Comparable	95	6400944312	220312	Comparable	256

Questions regarding close comparables? Contact us for details/samples.

If you do not see a Kinter match for what you are looking for, please contact our Sales Department for a prompt quotation.

* Kinter's (K International, Inc.'s) parts are not manufactured by or connected in any way with siffron™.

"Comparable" is defined as "may not be identical to the siffron part, but generally corresponds to the siffron part and is suitable for the customer's intended use."

"Close Comparable" is defined as "generally corresponds to the siffron part and is suitable for the customer's intended use, but may be slightly different in dimensions, aesthetics, materials or function."

siffron™ Item #	Kinter Item #	Match Type	Page #	siffron™ Item #	Kinter Item #	Match Type	Page #
6400944313	220318	Comparable	256	6402212505	102053	Close Comparable	273
6401020005	105125	Comparable	271	6402212506	102054	Close Comparable	273
6401020006	105125	Comparable	271	6402212507	102055	Close Comparable	273
6401020010	105126	Comparable	271	6402289600	107029	Close Comparable	260
6401020011	105126	Comparable	271	6402289601	107029	Comparable	260
6401020015	105127	Comparable	271	6402293801	102050	Comparable	273
6401020016	105127	Comparable	271	6402293802	102051	Comparable	273
6401028100	106001	Comparable	263	6402293803	102052	Comparable	273
6401046701	107021	Comparable	262	6402398200	107001	Comparable	263
6401051201	105155	Comparable	270	6402440301	107063	Comparable	253
6401325011	105125	Close Comparable	271	6402440401	107064	Comparable	253
6401325012	105126	Close Comparable	271	6402522501	107044B	Comparable	253
6401325013	105127	Close Comparable	271	6402522502	107046B	Comparable	253
6401420300	107163	Comparable	259	6402522503	107048B	Comparable	253
6401642801	108030	Comparable	255	6402557001	107084C	Comparable	252
6401642802	108031	Comparable	255	6402557002	107086C	Comparable	252
6401642803	108032	Comparable	255	6402557003	107088C	Comparable	252
6401693801	107084	Close Comparable	252	6403835401	411240	Comparable	249
6401693802	107084	Comparable	252	6404453501	107018	Comparable	258
6401693803	107086	Comparable	252	6404866075	104001	Comparable	272
6401693804	107088	Comparable	252	6405425800	107026	Comparable	259
6401739901	104014	Comparable	272	6405425801	107027	Comparable	259
6401768901	107034	Comparable	253	6406351801	107034C	Close Comparable	253
6401768902	107036	Comparable	253	6406351802	107036C	Close Comparable	253
6401768903	107038	Comparable	253	6406351803	107038C	Close Comparable	253
6401988201	107044	Comparable	253	6406448201	108013	Comparable	256
6401988202	107046	Comparable	253	6406643201	107015	Close Comparable	258
6401988203	107048	Comparable	253	6406643202	107015	Close Comparable	258
6401988204	107046C	Comparable	253	6406643203	107015C	Close Comparable	258
6401988207	107044C	Comparable	253	6407448101	107025	Comparable	259
6401988208	107048C	Comparable	253	6407455600	108040	Comparable	252
6402031405	104001	Close Comparable	272	6407486401	107010	Comparable	258
6402065000	108001	Comparable	257	6407486402	107010	Comparable	258
6402065001	108002	Comparable	257	6407486403	107010	Close Comparable	258
6402151901	107003	Comparable	263	6407743201	107017	Close Comparable	258
6402151902	107056B	Comparable	252	6407743202	107017C	Close Comparable	258
6402151904	107056	Close Comparable	252	6407818301	108041	Comparable	252
6402196100	106002	Comparable	234, 257	6407818303	108042	Comparable	252
6402212501	102053	Comparable	273	6407842801	108011	Comparable	256
6402212502	102054	Comparable	273	6407842802	108014	Comparable	256
6402212503	102055	Comparable	273	6407842803	108016	Comparable	256

Questions regarding close comparables? Contact us for details/samples.

If you do not see a Kinter match for what you are looking for, please contact our Sales Department for a prompt quotation.

* Kinter's (K International, Inc.'s) parts are not manufactured by or connected in any way with siffron™.

"Comparable" is defined as "may not be identical to the siffron part, but generally corresponds to the siffron part and is suitable for the customer's intended use."

"Close Comparable" is defined as "generally corresponds to the siffron part and is suitable for the customer's intended use, but may be slightly different in dimensions, aesthetics, materials or function."



siffron™ Item #	Kinter Item #	Match Type	Page #	siffron™ Item #	Kinter Item #	Match Type	Page #
6407842804	108018	Comparable	256	6507809500	109012C	Comparable	254
6407842805	108020	Comparable	256	6507809502	109018C	Comparable	254
6407842806	108021	Comparable	256	6507809503	109001C	Comparable	254
6407842807	108023	Comparable	256	6507809504	109002C	Comparable	254
6407842809	108010	Comparable	256	6507809505	109003C	Comparable	254
6407842813	108012	Comparable	256	6507809506	109004C	Comparable	254
6407842814	108015	Comparable	256	6507809507	109006C	Comparable	254
6407842845	108017	Comparable	256	6507809508	109008C	Comparable	254
6407850801	107019	Comparable	259	6507809511	109024C	Comparable	254
6407890301	107053	Comparable	253	6507809536	109036C	Comparable	254
6407890401	107054	Comparable	253	6508106201	109001	Comparable	254
6407914301	107023	Comparable	260	6508106202	109002	Comparable	254
6407961301	107028	Comparable	260	6508106203	109003	Comparable	254
6408034201	220204	Comparable	256	6508106204	109004	Comparable	254
6408034202	220206	Comparable	256	6508106206	109006	Comparable	254
6408034203	220208	Comparable	256	6508106208	109008	Comparable	254
6408034204	220212	Comparable	256	6508106212	109012	Comparable	254
6408034205	220216	Comparable	256	6508106218	109018	Comparable	254
6408092800	107024	Comparable	260	7000863403	130201	Close Comparable	74
6408153601	107034	Close Comparable	253	7001673901	130201	Close Comparable	74
6408153602	107036	Close Comparable	253	7001673902	130201	Close Comparable	74
6408153603	107038	Close Comparable	253	7001783003	130201	Comparable	74
6408957900	107035	Comparable	261	7001866602	130203	Comparable	76
6409059101	107009	Comparable	264	7001866606	130203B	Comparable	76
6409520001	107044B	Close Comparable	253	7001866612	130204	Comparable	76
6409520002	107046B	Close Comparable	253	7001866616	130204B	Comparable	76
6409520003	107048B	Close Comparable	253	7002533705	130207	Close Comparable	75
6409606701	102001	Comparable	267	7002569193	130203	Close Comparable	76
6409606702	102002	Comparable	267	7002989786	130200	Close Comparable	74
6409606703	102003	Comparable	267	7003033705	130207	Comparable	75
6409606706	102004	Comparable	267	7003033706	130207	Close Comparable	75
6409606724	102005	Comparable	267	7003033717	130207B	Comparable	75
6409606727	102012	Comparable	267	7003257304	130210	Comparable	73
6504440701	109052B	Comparable	255	7003857001	130202	Close Comparable	74
6504440702	109054B	Comparable	255	7003997200	130209	Close Comparable	17, 76
6504440703	109056B	Comparable	255	7004080100	130200	Comparable	74
6504440704	109058B	Comparable	255	7004080101	130200 + 108009	Comparable	74 + 79
6504440706	109051B	Comparable	255	7004080102	130200 + 108009	Close Comparable	74 + 79
6504440707	109053B	Comparable	255	7004202420	130200	Close Comparable	74
6504440708	109062B	Comparable	255	7005149868	130200	Close Comparable	74
6504440709	109068B	Comparable	255	7007262621	130200	Close Comparable	74

Questions regarding close comparables? Contact us for details/samples.

If you do not see a Kinter match for what you are looking for, please contact our Sales Department for a prompt quotation.

* Kinter's (K International, Inc.'s) parts are not manufactured by or connected in any way with siffron™.

“Comparable” is defined as “may not be identical to the siffron part, but generally corresponds to the siffron part and is suitable for the customer’s intended use.”

“Close Comparable” is defined as “generally corresponds to the siffron part and is suitable for the customer’s intended use, but may be slightly different in dimensions, aesthetics, materials or function.”

siffron™ Item #	Kinter Item #	Match Type	Page #	siffron™ Item #	Kinter Item #	Match Type	Page #
7007491701	130216	Close Comparable	75	7111756178	160774	Comparable	50
7007491702	130216	Close Comparable	75	7111967878	161170	Close Comparable	50
7007491703	130218	Close Comparable	75	7112067198	160874	Comparable	51
7007491741	130215	Close Comparable	75	7112668880	160848	Comparable	51
7007888905	130201	Close Comparable	74	7112673930	161044	Comparable	52
7007888910	130200	Close Comparable	74	7113006324	161148	Comparable	50
7007888960	130202	Close Comparable	74	7113380371	161174	Comparable	50
7007898001	107995	Comparable	78	7113894056	160842	Comparable	51
7009493989	130200	Close Comparable	74	7114262460	160876	Comparable	51
7101997200	108510	Comparable	207	7114291969	160642	Comparable	50
7101997202	108510C	Comparable	207	7114774699	161178	Comparable	50
7101997203	108509C	Comparable	207	7114814056	160846	Comparable	51
7102799100	108511	Comparable	207	7115180381	160676	Comparable	50
7102985200	107342	Comparable	60	7116050087	160674	Comparable	50
7102985201	107344	Comparable	60	7116420434	160776	Comparable	50
7102985202	107346	Comparable	60	7116471647	161074	Comparable	52
7105617001	107110	Comparable	148	7116552391	161178	Close Comparable	50
7106414001	109547	Comparable	48	7116596741	161176	Comparable	50
7106414002	109548	Comparable	48	7116968019	161176	Close Comparable	50
7106414003	109549	Comparable	48	7117154678	160646	Comparable	50
7106414004	109550	Comparable	48	7117587984	161174	Close Comparable	50
7106495101	107334	Comparable	60	7117727254	161048	Comparable	52
7106495102	107336	Comparable	60	7118148926	161142	Comparable	50
7108021401	107462	Comparable	59	7118438929	160844	Comparable	51
7108021402	107464	Comparable	59	7118751605	161076	Comparable	52
7108021403	107466	Comparable	59	7118914747	160678	Comparable	50
7108021404	107468	Comparable	59	7119110171	160742	Comparable	50
7108021405	107463	Comparable	59	7119140794	161140	Comparable	50
7108021406	107468	Close Comparable	59	7119179174	160748	Comparable	50
7108156000	108512	Close Comparable	207	7119185296	160778	Comparable	50
7108156002	108512	Comparable	207	7119526273	160878	Comparable	51
7108156004	108512	Close Comparable	207	7121201316	161240	Comparable	53
7110109132	161170	Comparable	50	7121806233	160540	Comparable	51
7110361231	161046	Comparable	52	7121888452	161270	Comparable	53
7110387491	160640	Comparable	50	7122557226	160544	Comparable	51
7110521837	160746	Comparable	50	7123206160	160572	Comparable	51
7110524975	160840	Comparable	51	7125838750	160548	Comparable	51
7110712407	161040	Comparable	52	7126078945	161244	Comparable	53
7110864564	160744	Comparable	50	7126135641	161278	Comparable	53
7111121663	160740	Comparable	50	7126432256	161274	Comparable	53
7111534480	161042	Comparable	52	7126533270	161248	Comparable	53

Questions regarding close comparables? Contact us for details/samples.

If you do not see a Kinter match for what you are looking for, please contact our Sales Department for a prompt quotation.

* Kinter's (K International, Inc.'s) parts are not manufactured by or connected in any way with siffron™.

"Comparable" is defined as "may not be identical to the siffron part, but generally corresponds to the siffron part and is suitable for the customer's intended use."

"Close Comparable" is defined as "generally corresponds to the siffron part and is suitable for the customer's intended use, but may be slightly different in dimensions, aesthetics, materials or function."



siffron™ Item #	Kinter Item #	Match Type	Page #	siffron™ Item #	Kinter Item #	Match Type	Page #
7127327856	160598	Comparable	51	7202097344	107434	Close Comparable	55
7127742756	161242	Comparable	53	7202097346	107436	Close Comparable	55
7129369243	160546	Comparable	51	7202097354	107234	Close Comparable	55
7129461263	161246	Comparable	53	7202097356	107236	Close Comparable	55
7129543379	161272	Comparable	53	7202205901	107302	Comparable	55
7129585902	161276	Comparable	53	7202205902	107304	Comparable	55
7129896616	160594	Comparable	51	7202205903	107305	Comparable	55
7130654100	107508B	Comparable	61	7202205904	107306	Comparable	55
7140588027	160248	Comparable	54	7202205905	107307	Comparable	55
7140783932	160248	Close Comparable	54	7202205906	107308	Comparable	55
7141747738	160248	Comparable	54	7202205907	107301	Comparable	55
7142371204	161402	Comparable	13, 54	7202205908	107304B	Comparable	55
7142791069	160244	Comparable	54	7202205909	107306B	Comparable	55
7143422797	160246	Comparable	54	7202205911	107305B	Comparable	55
7146471055	160246	Comparable	54	7202205912	107303	Comparable	55
7154218959	200009	Close Comparable	15, 64	7202205913	107303B	Comparable	55
7155972891	107737	Comparable	52	7202205915	107302B	Comparable	55
7156027916	107701	Comparable	53, 152	7202205916	107307B	Comparable	55
7156122490	107734	Comparable	52	7202205917	107308B	Comparable	55
7156984706	107704	Close Comparable	53	7202224201	107312	Comparable	59
7157802299	200009	Close Comparable	15, 64	7202224202	107314	Comparable	59
7158488236	107501	Close Comparable	62	7202224203	107316	Comparable	59
7164238609	180200	Comparable	14, 54	7202224204	107316	Close Comparable	59
7200191500	107232	Comparable	55	7202224207	107313	Comparable	59
7200191501	107234	Comparable	55	7204051372	107284	Comparable	60
7200191502	107236	Comparable	55	7204414400	107371	Comparable	58
7200191505	107233	Comparable	55	7204414401	107372	Comparable	58
7201451301	107384	Comparable	57	7204414402	107374	Comparable	58
7201451302	107386	Comparable	57	7204414403	107376	Comparable	58
7202097301	107323	Comparable	56	7204414404	107378	Comparable	58
7202097302	107323B	Comparable	56	7205113201	107444	Comparable	58
7202097303	107324	Comparable	56	7205113205	107444	Close Comparable	58
7202097304	107325	Comparable	56	7205391600	107392	Comparable	57
7202097305	107325B	Comparable	56	7205391601	107394	Comparable	57
7202097306	107326	Comparable	56	7205391602	107396	Comparable	57
7202097307	107327	Comparable	56	7207158501	107293	Comparable	56
7202097311	107324B	Comparable	56	7207158502	107294	Comparable	56
7202097312	107326B	Comparable	56	7207158503	107295	Comparable	56
7202097315	107327B	Comparable	56	7207158504	107296	Comparable	56
7202097316	107322	Comparable	56	7207158506	107298	Comparable	56
7202097317	107322B	Comparable	56	7207394459	107434	Close Comparable	55

Questions regarding close comparables? Contact us for details/samples.

If you do not see a Kinter match for what you are looking for, please contact our Sales Department for a prompt quotation.

* Kinter's (K International, Inc.'s) parts are not manufactured by or connected in any way with siffron™.

“Comparable” is defined as “may not be identical to the siffron part, but generally corresponds to the siffron part and is suitable for the customer’s intended use.”

“Close Comparable” is defined as “generally corresponds to the siffron part and is suitable for the customer’s intended use, but may be slightly different in dimensions, aesthetics, materials or function.”

siffron™ Item #	Kinter Item #	Match Type	Page #	siffron™ Item #	Kinter Item #	Match Type	Page #
7207541201	107422	Comparable	57	7708983816	180031B	Close Comparable	17, 81
7208173300	107304	Close Comparable	55	7900805801	107117	Comparable	77
7208360768	107286	Comparable	60	7900806900	150215B	Comparable	71
7208503000	107262	Comparable	58	7902240901	108035	Comparable	77
7208503001	107264	Comparable	58	7902240903	108036	Comparable	77
7208503002	107266	Comparable	58	7902260901	107121	Comparable	77
7208503003	107268	Comparable	58	7902260902	107122	Comparable	77
7208503004	107263	Comparable	58	7902277600	108009	Comparable	79
7208628813	107365	Comparable	59	7902277601	108029	Comparable	79
7209274701	107434	Comparable	55	7902290500	108029	Close Comparable	79
7209274702	107436	Comparable	55	7902535500	107502	Comparable	61
7209274705	107434	Close Comparable	55	7903096444	107122	Close Comparable	77
7209873601	107363	Comparable	59	7903160101	108000	Comparable	79
7209873602	107364	Comparable	59	7903950520	109526	Comparable	63
7209873603	107365	Comparable	59	7903950561	109527	Comparable	63
7209873604	107366	Comparable	59	7904229701	107504	Comparable	62
7209873605	107366	Close Comparable	59	7904229702	107504B	Comparable	62
7209873606	107366	Close Comparable	59	7904229703	107504	Close Comparable	62
7252641801	160648	Comparable	50	7904229704	107504C	Comparable	62
7252641802	160640	Comparable	50	7904421001	150960	Close Comparable	19, 82
7252641803	160642	Comparable	50	7904421002	150960	Close Comparable	19, 82
7253469301	160548	Comparable	51	7904583401	107503	Comparable	61
7253469302	160540	Comparable	51	7905810401	109545	Comparable	78
7253469303	160542	Comparable	51	7905953300	150155	Comparable	175
7256652001	160574	Comparable	51	7906132101	107146	Comparable	76
7256652002	160576	Comparable	51	7906924422	107118	Comparable	71
7256652003	160578	Comparable	51	7907115401	107500	Close Comparable	62
7256652004	160570	Comparable	51	7907115405	107501	Comparable	62
7257547001	109508	Comparable	51	7907341458	130609	Comparable	162
7257547002	160594	Comparable	51	7907471301	108003	Comparable	79, 257, 271
7257547003	160596	Comparable	51	7907471304	108004	Comparable	79, 257, 271
7257547004	160598	Comparable	51	7907532300	101001	Comparable	231
7259192101	160674	Comparable	50	7907532302	101008	Comparable	231
7259192102	160676	Comparable	50	7907783301	107506W	Comparable	62
7259192103	160678	Comparable	50	7907783302	107507B	Comparable	62
7301647103	150250	Comparable	72	7908010001	107505	Comparable	62
7307770901	150260	Comparable	73	7908166200	109517	Comparable	80
7307895301	150251	Comparable	72	7908684479	108007	Close Comparable	79, 257, 271
7400894125	170966	Comparable	19, 82	7909128401	116800	Comparable	21, 78, 108
7401878839	170967	Comparable	19, 82	7909128402	106801	Comparable	100
7407881267	170968	Comparable	19, 82	7909128403	106802	Comparable	100

Questions regarding close comparables? Contact us for details/samples.

If you do not see a Kinter match for what you are looking for, please contact our Sales Department for a prompt quotation.

* Kinter's (K International, Inc.'s) parts are not manufactured by or connected in any way with siffron™.

"Comparable" is defined as "may not be identical to the siffron part, but generally corresponds to the siffron part and is suitable for the customer's intended use."

"Close Comparable" is defined as "generally corresponds to the siffron part and is suitable for the customer's intended use, but may be slightly different in dimensions, aesthetics, materials or function."



siffron™ Item #	Kinter Item #	Match Type	Page #	siffron™ Item #	Kinter Item #	Match Type	Page #
8111692700	108603W	Comparable	192	8201002101	107134	Close Comparable	196
8111692707	108603	Comparable	192	8201002102	107134	Comparable	196
8111692741	108073	Comparable	190	8201375206	107147B	Close Comparable	196
8111692742	108074	Comparable	190	8201375230	107147B	Comparable	196
8111692743	108075	Comparable	190	8201711002	107075	Comparable	197
8111692751	108070	Comparable	190	8201711003	107076	Comparable	197
8111692752	108072	Comparable	190	8201712000	107129	Comparable	197
8111692753	108071	Comparable	190	8201888500	107400	Comparable	180
8111749800	108727	Comparable	194	8201888501	107400B	Comparable	180
8112270600	108670W	Comparable	193	8201888502	107401B	Comparable	180
8112270601	108670	Comparable	193	8201888503	107402B	Comparable	180
8112330800	108557W	Comparable	192	8201888504	107403B	Comparable	180
8112330802	108557	Comparable	192	8201888505	107401	Comparable	180
8112394600	108615W	Comparable	192	8201888507	107402	Comparable	180
8112394602	108615	Comparable	192	8201888508	107403	Comparable	180
8112733301	108609	Comparable	138, 195	8201973101	107159	Comparable	189
8112733302	108610	Comparable	138, 195	8201973102	107160	Comparable	189
8115266600	108537W	Comparable	192	8201973103	107161	Comparable	189
8115266601	108537	Comparable	192	8202174500	107139	Comparable	197
8116072200	108671W	Comparable	193	8202270001	109515	Comparable	199
8116072201	108671	Comparable	193	8202466600	107137	Close Comparable	196
8116202801	108723	Comparable	193	8202702401	150625	Comparable	190
8116493200	108616W	Comparable	192	8202702403	150625W	Comparable	190
8116493201	108616	Comparable	192	8202702404	150625B	Comparable	190
8116662500	108538W	Comparable	192	8202735401	108613	Comparable	195
8116662501	108538	Comparable	192	8203788801	107140 + 107141	Comparable	188
8117296100	108604W	Comparable	192	8203788802	107142 + 107143	Comparable	188
8117296101	108604	Comparable	192	8203788821	107140 + 107141	Close Comparable	188
8117602701	108518	Comparable	138, 195	8203788822	107142 + 107143	Close Comparable	188
8117602702	108519	Comparable	138, 195	8203788871	107143	Comparable	188
8118033200	108558W	Comparable	192	8203788872	107140	Comparable	188
8118033202	108558	Comparable	192	8203788873	107141	Comparable	188
8118088200	108581	Comparable	194	8203788876	107142	Comparable	188
8118110300	108571	Comparable	194	8204394601	108689	Comparable	195
8118842802	108580	Comparable	193	8204394602	108688	Comparable	195
8200000300	107133	Comparable	197	8204394603	108689	Close Comparable	195
8200187301	109514	Comparable	199	8204394604	108688	Close Comparable	195
8200276700	107076	Comparable	197	8207511700	150651	Comparable	221
8200735101	107156	Comparable	189	8207511701	150650	Comparable	221
8200735102	107157	Comparable	189	8207528800	107144	Comparable	196
8200735103	107158	Comparable	189	8207528865	107145	Comparable	196

Questions regarding close comparables? Contact us for details/samples.

If you do not see a Kinter match for what you are looking for, please contact our Sales Department for a prompt quotation.

* Kinter's (K International, Inc.'s) parts are not manufactured by or connected in any way with siffron™.

“Comparable” is defined as “may not be identical to the siffron part, but generally corresponds to the siffron part and is suitable for the customer’s intended use.”

“Close Comparable” is defined as “generally corresponds to the siffron part and is suitable for the customer’s intended use, but may be slightly different in dimensions, aesthetics, materials or function.”

siffron™ Item #	Kinter Item #	Match Type	Page #	siffron™ Item #	Kinter Item #	Match Type	Page #
8207732700	107149	Comparable	188	8500964101	120229	Comparable	214
8208077500	107148	Comparable	188	8501731692	120201	Comparable	215
8208105500	107138	Comparable	197	8501919701	120227B	Comparable	214
8300323700	107114	Comparable	205	8501936201	120397	Comparable	209
8300904000	140896	Comparable	25, 139	8501936202	120397B	Comparable	209
8301009823	181518S	Comparable	18, 81	8501936203	120398	Comparable	209
8301105200	107105	Comparable	206	8501936204	120398B	Comparable	209
8301263612	181518S	Comparable	18, 81	8502034500	100056 + 100052	Comparable	226
8301463094	107102	Close Comparable	204	8502034501	100054 + 100051	Comparable	226
8301867600	107101	Comparable	204	8502034505	100048 + 100050	Comparable	226
8302043300	108868	Comparable	136	8502101300	120400	Comparable	211
8302092201	107104	Comparable	204	8502196752	120203	Comparable	215
8302092203	107103	Comparable	204	8502232601	120305	Comparable	208, 239
8302274800	107108	Comparable	203	8502232602	120300	Comparable	208
8302274810	107119	Comparable	203	8502259852	120329	Comparable	208
8304220602	181522	Comparable	18, 81	8502477405	120205	Comparable	214
8304874545	181518	Comparable	18, 81	8502477406	120205B	Comparable	214
8304960000	107115	Comparable	205	8502477408	120205C	Comparable	214
8305630200	107116	Comparable	205	8502526600	120433	Comparable	209
8306458401	181518S	Comparable	18, 81	8503838349	120320	Comparable	208
8307603700	107102	Comparable	204	8504284490	120210	Comparable	215
8307625300	107100	Comparable	204	8504793505	120208	Comparable	215
8307711301	109521	Comparable	206	8505579001	120232	Comparable	214
8307842300	107107	Comparable	205	8506037064	120327	Comparable	208
8307993600	107113	Comparable	206	8506232201	120305	Comparable	208, 239
8309277392	181522	Comparable	18, 81	8506232202	120300	Comparable	208
8317095900	108590	Comparable	136	8506232211	120305B	Comparable	208
8401277701	106930	Close Comparable	21, 109	8506232212	120300B	Comparable	208
8402281201	107127	Close Comparable	78	8506495201	120401	Comparable	209
8402281202	107127	Comparable	78	8506495202	120402B	Comparable	209
8402281203	107128	Comparable	78	8507371901	105063	Comparable	223
8408087600	107180	Comparable	125	8507484801	100545 + 100551	Comparable	230
8408729001	107118	Comparable	71	8507484804	100547 + 100552	Comparable	230
8408729030	150222	Comparable	71	8507484806	100556 + 100552	Comparable	230
8408729060	150222	Close Comparable	71	8507484808	100558 + 100552	Comparable	230
8500000100	120307	Comparable	208	8507501000	120435	Comparable	209
8500000101	120302	Comparable	208	8507552101	120403	Close Comparable	209
8500000105	120303	Comparable	208	8507552102	120403	Close Comparable	209
8500000106	120304	Comparable	208	8507552103	120403	Comparable	209
8500000201	120213B	Comparable	214	8507552105	120404	Close Comparable	209
8500600401	100058 + 100052	Comparable	226	8507552106	120404	Comparable	209

Questions regarding close comparables? Contact us for details/samples.

If you do not see a Kinter match for what you are looking for, please contact our Sales Department for a prompt quotation.

* Kinter's (K International, Inc.'s) parts are not manufactured by or connected in any way with siffron™.

"Comparable" is defined as "may not be identical to the siffron part, but generally corresponds to the siffron part and is suitable for the customer's intended use."

"Close Comparable" is defined as "generally corresponds to the siffron part and is suitable for the customer's intended use, but may be slightly different in dimensions, aesthetics, materials or function."



siffron™ Item #	Kinter Item #	Match Type	Page #	siffron™ Item #	Kinter Item #	Match Type	Page #
8507552107	120404	Close Comparable	209	8605694802	150675	Comparable	221, 284
8507563101	120401	Close Comparable	209	8605694807	150675	Close Comparable	221, 284
8507563102	120402B	Close Comparable	209	8607460001	107050	Comparable	217
8507677170	120209	Comparable	215	8607460004	107037	Comparable	216
8507680003	120450B	Comparable	210	8607554201	107033	Comparable	216
8507680004	120405	Comparable	210	8607554202	107039	Comparable	261
8507779703	120431	Comparable	211	8607695200	107042	Comparable	218
8507779704	120431B	Comparable	211	8609168601	150675	Close Comparable	221, 284
8507858965	120325	Comparable	208	8640289357	130507	Comparable	202
8507868300	120213	Comparable	214	8701592601	108055B	Comparable	198
8507868320	120213	Close Comparable	214	8701858802	107600 + 107603	Close Comparable	198
8507910701	140215 + 140216	Comparable	222	8701858820	107600 + 107603	Close Comparable	198
8507910703	140216	Comparable	222	8701858822	107600 + 107603	Close Comparable	198
8507910705	140215 + 140216	Close Comparable	222	8701858823	107601B + 107604B	Comparable	198
8507936700	120403	Close Comparable	209	8701858830	107602B + 107605B	Comparable	198
8507964104	120418	Comparable	212	8702023402	107152	Comparable	200
8507964105	120418B	Comparable	212	8702035100	107151	Comparable	201
8508012300	120200	Comparable	215	8702441502	107153	Comparable	200
8508411500	120430	Comparable	211	8702467100	107601 + 107604	Comparable	198
8508411501	120430B	Comparable	211	8707740401	108724	Comparable	200
8509317100	120450B	Comparable	210	8707784101	108050	Comparable	198
8509317101	120450	Comparable	210	8707784102	108051	Comparable	198
8509866214	120418C	Close Comparable	212	8707784103	108052	Comparable	198
8509932401	100055 + 100052	Comparable	226	8707939600	107602 + 107605	Comparable	198
8530402400	120451	Comparable	210	8708146800	109519	Comparable	199
8530402413	120451	Comparable	210	8708262000	107600	Comparable	198
8530402437	120451B	Comparable	210	8708262001	107603	Comparable	198
8532988000	120407	Close Comparable	211	8708262002	107602	Comparable	198
8532988002	120407	Comparable	211	8708262003	107605	Comparable	198
8532988003	120407B	Comparable	211	8708262004	107601	Comparable	198
8535553601	105015	Comparable	223	8708262005	107604	Comparable	198
8537965600	105091	Close Comparable	224	8708713000	107600 + 107603	Close Comparable	198
8538485500	109520	Comparable	209	8708800601	108591	Comparable	200
8539766200	120452	Comparable	210	8708800602	140909	Comparable	200
8601868601	107043	Comparable	218	8718178201	108060	Comparable	199
8601879401	150682	Comparable	220	8807998102	150606B	Comparable	219
8601936101	107041	Comparable	218	8807998103	150606	Comparable	219
8602034500	150683	Comparable	220	8807998105	150608B	Comparable	219
8602165700	150680	Comparable	220	8807998106	150608	Comparable	219
8602389402	150681	Comparable	220	8808018002	150607B	Comparable	219
8602789901	107030	Comparable	80, 261	8808018003	150607	Comparable	219
8602789902	107031	Comparable	80, 261	8808018005	150609B	Comparable	219

Questions regarding close comparables? Contact us for details/samples.

If you do not see a Kinter match for what you are looking for, please contact our Sales Department for a prompt quotation.

* Kinter's (K International, Inc.'s) parts are not manufactured by or connected in any way with siffron™.

“Comparable” is defined as “may not be identical to the siffron part, but generally corresponds to the siffron part and is suitable for the customer’s intended use.”

“Close Comparable” is defined as “generally corresponds to the siffron part and is suitable for the customer’s intended use, but may be slightly different in dimensions, aesthetics, materials or function.”

siffron™ Item #	Kinter Item #	Match Type	Page #	siffron™ Item #	Kinter Item #	Match Type	Page #
8808018006	150609	Comparable	219	9920710855	150232B	Close Comparable	88
8808145901	150502B	Comparable	219	9920710869	140802B	Comparable	38
8808145902	150502	Comparable	219	9920710978	150205B	Comparable	87
8808145905	150506B	Comparable	219	9920711122	150213B	Comparable	86
8808145906	150506	Comparable	219	9920711201	108570T	Comparable	37, 94
8808173501	150503B	Comparable	219	9920711650	150707B	Close Comparable	26, 165
8808173502	150503	Comparable	219	9920711836	150201B	Comparable	86
8808173505	150507B	Comparable	219	9920712071	150430B	Comparable	165
8808173506	150507	Comparable	219	9920712144	150212B	Comparable	86
9101740000	150122	Close Comparable	175	9920713128	150217B	Comparable	88
9201654601	150130	Close Comparable	174	9920713202	150202B	Comparable	86
9207669201	150130	Close Comparable	174	9920713682	140803B	Close Comparable	38
9208059401	150130	Comparable	174	9920713708	150424	Comparable	164
9301653101	150826	Close Comparable	174	9920713839	150186	Comparable	185
9301653141	150831	Comparable	177	9920714252	150211B	Comparable	164
9301716002	150136	Close Comparable	173	9920714418	108881	Comparable	127
9302421701	150142	Close Comparable	174	9920714447	150430B	Close Comparable	165
9307696509	150137	Comparable	176	9920714826	150186	Close Comparable	185
9307994141	150138	Comparable	176	9920715452	150305	Close Comparable	156
9308009201	150141	Close Comparable	174	9920715453	150302	Close Comparable	154
9407606001	150107	Comparable	174	9920715454	150301	Close Comparable	154
9407606002	150110	Comparable	174	9920715455	150314	Close Comparable	155
9407823501	150105	Comparable	174	9920715460	150706B	Close Comparable	165
9407823502	150108	Comparable	174	9920715971	109564	Comparable	145
9408140501	150106	Comparable	174	9920716315	150314	Close Comparable	155
9408140502	150109	Comparable	174	9920716316	150314	Comparable	155
9502218824	150195B	Comparable	91	9920716618	150203B	Comparable	86
9502218836	150196B	Comparable	91	9920716818	150210B	Comparable	164
9502218848	150197B	Comparable	91	9920716904	140771	Close Comparable	143
9502275300	150439	Close Comparable	90	9920717339	140779B	Comparable	36
9503566701	150421	Close Comparable	90	9920717435	108844	Comparable	144
9503566702	150219B	Comparable	90	9920717452	150206B	Comparable	86
9504360151	109571	Close Comparable	91	9920717620	150185	Comparable	185
9709339401	150150	Comparable	180	9920717691	150209B	Comparable	164
9709339402	150151	Comparable	180	9920718563	150201B	Comparable	86
9920710008	150207B	Comparable	86	9920719611	140752B	Comparable	38
9920710126	150431B	Comparable	165	9920719670	150428	Comparable	164
9920710499	150314	Close Comparable	155	9920811861	108570B	Close Comparable	37, 94
9920710650	150426B	Close Comparable	165	9923018692	180029	Close Comparable	19, 82
9920710660	150204B	Comparable	87	Z102562500	105092	Comparable	224
9920710671	150224	Comparable	145	Z107531121	100000	Close Comparable	Call for details

Questions regarding close comparables? Contact us for details/samples.

If you do not see a Kinter match for what you are looking for, please contact our Sales Department for a prompt quotation.

* Kinter's (K International, Inc.'s) parts are not manufactured by or connected in any way with siffron™.

"Comparable" is defined as "may not be identical to the siffron part, but generally corresponds to the siffron part and is suitable for the customer's intended use."

"Close Comparable" is defined as "generally corresponds to the siffron part and is suitable for the customer's intended use, but may be slightly different in dimensions, aesthetics, materials or function."



siffron™ Reference #	Kinter Item #	Match Type	Page #
214814	108564	Comparable	148
PVA-SC2NS	140700	Comparable	143
PVA-WB2NS	140620	Comparable	143
R-ATP08AL	220022	Close Comparable	277
R-ATP12AL	220024	Close Comparable	277
R-ATP18AL	220024	Comparable	277
R-ATP24AL	220024	Close Comparable	277
R-CPHB04	220250	Comparable	289
R-CPHB16	220251	Comparable	289
R-FLIPSH-12	108807	Comparable	32
R-FLIPSH-2	108559	Comparable	32
R-FLIPSH-3	108561	Comparable	32
R-FLIPSH-35	108573	Comparable	32
R-FLIPSH-4	108674	Comparable	32
R-FRSH-125	140896	Comparable	25, 139
R-HEM26BR	220121	Close Comparable	288
R-HEM26W	220121	Comparable	288
R-HEM36BR	220122	Close Comparable	288
R-HEM36W	220122	Comparable	288
R-HSMC48K	107072B	Comparable	188
R-HSMC48W	107072	Comparable	96
R-HVP-0406	150061	Comparable	170
R-KDR-R4T12-K	180031B	Close Comparable	17, 81
R-MCA	220100	Comparable	289
R-MGPH26	220480	Close Comparable	286
R-MGPH36	220481	Close Comparable	286
R-MH12	220507	Close Comparable	278
R-MH26	220508	Comparable	278
R-MH36	220509	Comparable	278
R-MHT26	220532	Comparable	278
R-MHT36	220533	Comparable	278
R-MMSA-26	220121	Close Comparable	288
R-MMSA-36	220122	Close Comparable	288
R-OCSH26	220536	Comparable	286
R-OCSH36	220537	Comparable	286
R-SH2W	108737	Comparable	135
R-SHA003K	150288B	Comparable	84
R-SHA003R	150288 + 150288B	Close Comparable	84
R-SHA003W	150288	Comparable	84

siffron™ Reference #	Kinter Item #	Match Type	Page #
R-SHA004K	150289B	Comparable	84
R-SHA004R	150289 + 150289B	Close Comparable	84
R-SHA004W	150289	Comparable	84
R-SHA006K	140989B	Comparable	84
R-SHA006W	140989	Comparable	84
R-SHA010	150285 + 150285B	Close Comparable	84
R-SHA010R	150285 + 150285B	Close Comparable	84
R-SHA017	140830	Close Comparable	84
R-SHB001W	140990	Comparable	84
R-SHB001K	140990B	Comparable	84
R-SHB002K	150286B	Comparable	84
R-SHB002R	150286 + 150286B	Close Comparable	84
R-SHB002W	150286	Comparable	84
R-SHB005K	150287B	Comparable	84
R-SHB005W	150287	Comparable	84
R-SHB006W	140991	Comparable	84
R-SHB006K	140991B	Comparable	84
R-SHGC	108844	Comparable	35
R-SH0557W-7	150179	Close Comparable	181
R-SH0711K-11	150281B	Comparable	84
R-SH0711R-11	150281 or 150281B	Close Comparable	84
R-SH0711W-11	150281	Comparable	84
R-SH0851K-85	150280B	Comparable	84
R-SH0851R-85	150280 + 150280B	Close Comparable	84
R-SH0851W-85	150280	Comparable	84
R-SHSC	107106	Comparable	145
R-SKHH24	110731	Comparable	246
R-SKHH36	110732	Comparable	246
R-SKHH48	110733	Comparable	246
R-SKS24	110805	Close Comparable	247
R-SKS36	110806	Close Comparable	247
R-SKS48	110807	Close Comparable	247
R-SMC06K	107006B	Comparable	96
R-SMC06W	107006	Comparable	96
R-SMC48K	107007B	Comparable	96
R-SMC48W	107007	Comparable	96
R-SSB-20X34	108839	Comparable	92, 250
R-SSP-11C	104204	Comparable	92
R-SSP-11D	104203	Comparable	92

Questions regarding close comparables? Contact us for details/samples.

If you do not see a Kinter match for what you are looking for, please contact our Sales Department for a prompt quotation.

* Kinter's (K International, Inc.'s) parts are not manufactured by or connected in any way with siffron™.

"Comparable" is defined as "may not be identical to the siffron part, but generally corresponds to the siffron part and is suitable for the customer's intended use."

"Close Comparable" is defined as "generally corresponds to the siffron part and is suitable for the customer's intended use, but may be slightly different in dimensions, aesthetics, materials or function."

siffron™ Reference #	Kinter Item #	Match Type	Page #	siffron™ Reference #	Kinter Item #	Match Type	Page #
R-SSP-11R	104205	Comparable	92	R16-3/4-LTE	150503	Comparable	219
R-SSSK24	110721	Close Comparable	95	R16-347037S	130200	Close Comparable	74
R-SSSK36	110722	Close Comparable	95	R16-347051S	130200 + 108009	Comparable	74 + 79
R-SSSK48	110723	Close Comparable	95	R16-35X55SH	108760	Comparable	127
R-SWCC-3	107018	Comparable	258	R16-35X55SHT	150160	Close Comparable	126
R-UMSH-3	106941	Comparable	104	R16-4W-100BG	107125	Close Comparable	130
R-UNITOOL-K10	105091	Comparable	224	R16-APSH-K2BX	150217B	Comparable	88
R-VPM-3555	150054	Comparable	171	R16-CC001	107015	Close Comparable	258
R-VPT-1252	150050	Comparable	171	R16-CC003	107025	Close Comparable	259
RJB-9713	200035B	Comparable	16, 66	R16-CC004	107025	Comparable	259
RJB-9713B	200030B	Comparable	16, 66	R16-CC005-6	107056	Close Comparable	252
RJB-9713Q	200031B	Comparable	16, 66	R16-CC006	106001	Comparable	97
RJB-9713Q2	200032B	Comparable	16, 66	R16-CC007-6	107036	Close Comparable	253
RJB-9713Y03	200033B	Comparable	16, 66	R16-CC011	107021	Comparable	262
RJB-9713Y05	200034B	Comparable	16, 66	R16-CHN12100	104003	Comparable	272
R0SHB005R	150287 + 150287B	Close Comparable	84	R16-CHN16250	104001	Close Comparable	273
R16-009	120400	Comparable	211	R16-CHNK24S4	104014	Comparable	273
R16-1-030	120418	Comparable	212	R16-CTP-002N	120208	Comparable	214
R16-104100	104100	Comparable	262	R16-CTP-004N	120210	Comparable	215
R16-11X85AHFSH	150232B	Close Comparable	88	R16-CTP-006N	120209	Comparable	215
R16-12-F	130202	Close Comparable	74	R16-CTP-008N	120205	Comparable	214
R16-12-F2125	130200	Close Comparable	74	R16-CTP-009N	120213	Comparable	215
R16-12-F3	130200	Close Comparable	74	R16-CTP-010N	120201	Comparable	215
R16-12-NLH	130218	Close Comparable	75	R16-CTP-011N	120203	Comparable	215
R16-12-STR	130201	Close Comparable	74	R16-CTP-025C	120418C	Close Comparable	212
R16-12-WCS	130216	Close Comparable	75	R16-HRS-C	150201B	Close Comparable	86
R16-12-WCS2	130215	Close Comparable	75	R16-HSR-1	101003	Comparable	232
R16-125-PWC	107100	Comparable	204	R16-HSR-150	101004	Comparable	232
R16-150-TT	130618	Close Comparable	163	R16-HSR-2	101005	Comparable	232
R16-2-CC	107164	Close Comparable	31	R16-HSR-3	101007	Comparable	232
R16-250-2	108829	Comparable	44	R16-HSR-750	101002	Comparable	232
R16-250-250	108033	Comparable	44	R16-HUW-C	150206B	Close Comparable	86
R16-250-3	108698	Close Comparable	44	R16-LEC-12	102002	Comparable	249
R16-250-78	108698	Comparable	44	R16-LEC-18	102003	Comparable	249
R16-250-CC	107170	Comparable	31	R16-LEC-24	102004	Comparable	249
R16-3-CC	107168	Comparable	31	R16-LEC-36	102005	Comparable	249
R16-3/4-HCE	150606	Comparable	219	R16-LEC-6	102001	Comparable	249
R16-3/4-HTE	150502	Comparable	219	R16-LP-1	109520	Comparable	209
R16-3/4-LCE	150607	Comparable	219	R16-PAN-12	120403	Comparable	209

Questions regarding close comparables? Contact us for details/samples.

If you do not see a Kinter match for what you are looking for, please contact our Sales Department for a prompt quotation.

* Kinter's (K International, Inc.'s) parts are not manufactured by or connected in any way with siffron™.

"Comparable" is defined as "may not be identical to the siffron part, but generally corresponds to the siffron part and is suitable for the customer's intended use."

"Close Comparable" is defined as "generally corresponds to the siffron part and is suitable for the customer's intended use, but may be slightly different in dimensions, aesthetics, materials or function."



siffron™ Reference #	Kinter Item #	Match Type	Page #	siffron™ Reference #	Kinter Item #	Match Type	Page #
R16-PAN-34	120404	Close Comparable	209	R21-6-M	160576	Comparable	51
R16-PAN-38	120403	Close Comparable	209	R21-6-S	160596	Comparable	51
R16-PSD2-PP	120451	Comparable	210	R21-8-H	160548	Comparable	51
R16-PWC-HD	107102	Close Comparable	204	R21-8-M	160578	Comparable	51
R16-PWC-HD2	107101	Comparable	204	R21-8-S	160598	Comparable	51
R16-PWC-HD3	107102	Comparable	204	R23	107701	Comparable	53, 152
R16-PWC-LW1	107107	Comparable	205	R23-10	161240	Comparable	53
R16-PWC-MW1	107115	Comparable	205	R23-12	161242	Comparable	53
R16-PWC-PSW1	107113	Comparable	206	R23-135	107505	Comparable	62
R16-PWC-SL15	107104	Comparable	204	R23-140-20	107163	Comparable	259
R16-PWC-SW1	107114	Comparable	205	R23-4	161244	Comparable	53
R16-PWC-WP1	107116	Comparable	205	R23-6	161246	Comparable	53
R16-SC-150-H	130611	Comparable	162	R23-8	161248	Comparable	53
R16-SC-EMH100	130602	Close Comparable	162	R24-S-1	108003	Comparable	79, 257, 271
R16-SC-EMH150	130603	Comparable	162	R24-S-2	108007	Close Comparable	79, 257, 272
R16-SC-MH212	130612	Comparable	162	R24-STR-S-B	108009	Comparable	79
R16-SC-MHD212	130604	Comparable	162	R24-STR-SPHB	108029	Close Comparable	79
R16-SC-MI-134	130609	Comparable	162	R30	107704	Close Comparable	53
R16-SC-PH134	130618	Close Comparable	163	R30-10	161270	Comparable	53
R16-SR-F	120320	Comparable	208	R30-12	161272	Comparable	53
R16-SR-M190	120325	Comparable	208	R30-4	161274	Comparable	53
R16-SR-M240	120327	Comparable	208	R30-6	161276	Comparable	53
R16-SR-M340	120329	Comparable	208	R30-8	161278	Comparable	53
R16-STR-SP-B	108029	Comparable	79	R33-10-212	160840	Comparable	51
R16-T-1	120458	Comparable	124	R33-10-212US	161040	Comparable	52
R16-T-1A	120459	Comparable	124	R33-12-212	160842	Comparable	51
R16-TREE-P1	120407	Close Comparable	211	R33-12-212US	161042	Comparable	52
R16-VRS-G	150421	Close Comparable	90	R33-186-100	107737	Comparable	52
R17-715	108100	Comparable	130	R33-212-100	107734	Comparable	52
R17-718-1/2	108529	Comparable	137	R33-4-186	160874	Comparable	51
R21-10-H	160540	Comparable	51	R33-4-186US	161074	Comparable	52
R21-10-M	160570	Comparable	51	R33-4-212	160844	Comparable	51
R21-12-H	160542	Comparable	51	R33-4-212US	161044	Comparable	52
R21-12-M	160572	Comparable	51	R33-6-186	160876	Comparable	51
R21-2-S	109508	Comparable	51	R33-6-186US	161076	Comparable	52
R21-4-H	160544	Comparable	51	R33-6-212	160846	Comparable	51
R21-4-M	160574	Comparable	51	R33-6-212US	161046	Comparable	41
R21-4-S	160594	Comparable	51	R33-8-186	160878	Comparable	51
R21-6-H	160546	Comparable	51	R33-8-212	160848	Comparable	51

Questions regarding close comparables? Contact us for details/samples.

If you do not see a Kinter match for what you are looking for, please contact our Sales Department for a prompt quotation.

* Kinter's (K International, Inc.'s) parts are not manufactured by or connected in any way with siffron™.

“Comparable” is defined as “may not be identical to the siffron part, but generally corresponds to the siffron part and is suitable for the customer's intended use.”

“Close Comparable” is defined as “generally corresponds to the siffron part and is suitable for the customer's intended use, but may be slightly different in dimensions, aesthetics, materials or function.”

siffron™ Reference #	Kinter Item #	Match Type	Page #	siffron™ Reference #	Kinter Item #	Match Type	Page #
R33-8-212US	161048	Comparable	52	R52-6-186US	161176	Close Comparable	50
R33LB-186-100	200009	Close Comparable	15, 64	R52-8-186US	161178	Close Comparable	50
R33LB-212-100	200009	Close Comparable	15, 64	R64-10-224-K	160248	Close Comparable	54
R35L-2	108695	Comparable	47	R64-4-224	160244	Comparable	54
R35L-3	140737	Comparable	47	R64-6-224	160246	Comparable	54
R35L-350	140681	Comparable	47	R64-6-224-K	160246	Comparable	54
R36L-2	108827	Comparable	47	R64-8-224	160248	Comparable	54
R36L-250	140881	Comparable	47	R64-8-224K	160248	Comparable	54
R43-WMH-HSRA	107122	Comparable	77	R72-23SSBH-W	104215W	Comparable	92
R43-WMH-HSRZ	107121	Comparable	77	RAD-15020-10	150170	Comparable	70
R43-WMHDCSH-A	107122	Close Comparable	77	RAD-15020-12	150171	Comparable	70
R44-WR-12	130203	Close Comparable	74	RAD-15020-14	150172	Comparable	70
R45-10-186US	161170	Comparable	50	RAD-15020-16	150173	Comparable	70
R45-10-212	160640	Comparable	50	RAD-15020-18	150174	Comparable	70
R45-10-212P2	160740	Comparable	50	RAL-2	150367	Close Comparable	10, 31
R45-10-212US	161140	Comparable	50	RAMS-3558	107118	Comparable	71
R45-12-212	160642	Comparable	50	RAPC-001-0 & RAPC-001-1	108505	Comparable	139
R45-12-212P2	160742	Comparable	50	RBC-CN312	102051	Comparable	273
R45-12-212US	161142	Comparable	50	RBC-CN612	102054	Comparable	273
R45-4-186	160674	Comparable	50	RBC-CN624	102055	Comparable	273
R45-4-186P2	160774	Comparable	50	RBC-CN660	102053	Comparable	273
R45-4-186US	161174	Comparable	50	RBMP-C01-1K	150651	Comparable	221
R45-4-212P2	160744	Comparable	50	RBMP-C05-1K	150650	Comparable	221
R45-6-186	160676	Comparable	50	RBS-LHW-0600	150141	Close Comparable	174
R45-6-186P2	160776	Comparable	50	RBS-LHW-9000	150142	Close Comparable	174
R45-6-186US	161176	Comparable	50	RBS-LK-4	150130	Close Comparable	174
R45-6-212	160646	Comparable	50	RBS-LT-403	150831	Comparable	177
R45-6-212P2	160746	Comparable	50	RBS-R1-1185	107410	Comparable	172
R45-8-186	160678	Comparable	50	RBS-R1-8511	107411	Comparable	126
R45-8-186P2	160778	Comparable	50	RBT-3-275A	150253	Comparable	73
R45-8-186US	161178	Comparable	50	RBT-325-125A	150252	Comparable	73
R45-8-212	160648	Comparable	50	RCBC-2-149	161402	Comparable	13, 54
R45-8-212P2	160748	Comparable	50	RCH-092	107003	Comparable	263
R45-8-212US	161148	Comparable	50	RCM2-114	107124	Comparable	124
R45AT-6-212US	200026	Comparable	14, 64	RCSS-100	107156	Comparable	189
R45AT-8-212US	200028	Comparable	14, 64	RCSS-100-AB	107159	Comparable	189
R45AT-10-212US	200020	Comparable	14, 64	RCSS-100-AB-ADH	107161	Comparable	189
R52-10-186US	161170	Close Comparable	50	RCSS-100-ADH	107158	Comparable	189
R52-4-186US	161174	Close Comparable	50	RCSS-15-20	107148	Comparable	188

Questions regarding close comparables? Contact us for details/samples.

If you do not see a Kinter match for what you are looking for, please contact our Sales Department for a prompt quotation.

* Kinter's (K International, Inc.'s) parts are not manufactured by or connected in any way with siffron™.

"Comparable" is defined as "may not be identical to the siffron part, but generally corresponds to the siffron part and is suitable for the customer's intended use."

"Close Comparable" is defined as "generally corresponds to the siffron part and is suitable for the customer's intended use, but may be slightly different in dimensions, aesthetics, materials or function."



siffron™ Reference #	Kinter Item #	Match Type	Page #	siffron™ Reference #	Kinter Item #	Match Type	Page #
RCSS-178-214	107140 + 107141	Comparable	188	RFG2-001-1	108523	Comparable	114
RCSS-200	107157	Comparable	189	RFG2-001-3	108524	Comparable	114, 239, 242, 245
RCSS-200-AB	107160	Comparable	189	RFG2-002-1	108525	Comparable	114
RCSS-238-214	107142 + 107143	Comparable	188	RFG2-002-1250	140670	Close Comparable	114
RDBTT2048-C	108625	Close Comparable	28	RFG2-002-3	108526	Comparable	114
RDBTT2048-W	108625W	Comparable	28	RFG2-002-3250	108527	Comparable	114
RDBTT3047E-C	108675	Comparable	28	RFG2-003-3	108520	Comparable	115
RDBTT3547E-C	108585W	Comparable	28	RFG2-003-3250	108551	Comparable	115
RDBTTG2029E-Q	140717	Comparable	28	RFG2-004-1	108515	Comparable	122
RDBTTG2047E-Q	108644	Comparable	28	RFG2-004-3	108517	Comparable	122
RDBTTGT2048-C	108778	Close Comparable	28	RFG2-008-1	130631	Comparable	161
RDBTTGT2048-W	108778	Close Comparable	28	RFG2-009-1	130632	Comparable	161
RDC-020	107202	Comparable	123	RFG2-010	108102	Comparable	131
RDC-021	107200	Comparable	129	RFG2-011-125	108637	Comparable	123
RDDWTF2030-W	140658W	Comparable	34	RFG2-013-200	108521	Comparable	137
RDFSTF2029-W	108692W	Comparable	35	RFG2-013-250	108665	Comparable	137
RDPHTFN2036H-C	108779	Close Comparable	45	RFG2-014	108608	Comparable	120
RDPHTFN2048H-C	108779	Close Comparable	45	RFG2-015	108676	Comparable	136
RDSH-WFD10	107146	Comparable	76	RFG2-016-1	108609	Comparable	138, 195
RDSICA2035G-K	108835B	Comparable	35	RFG2-016-150	108610	Comparable	138, 195
RDSIT2048-A	108785W	Close Comparable	29	RFG2-017-75	108579	Comparable	133
RDSIT2048-W	108785W	Comparable	29	RFG2-018-150	108503	Comparable	121
RDSITAN2048-A	108857	Close Comparable	30	RFG2-019-125	108590	Comparable	136
RDSITAN2048-W	108857	Close Comparable	30	RFG2-020-3	108730	Comparable	206
RDSITG2048-A	108757W	Close Comparable	29	RFG2-021-150	108580	Comparable	193
RDSITG2048-C	108757W	Close Comparable	29	RFG2-022-1	108105	Comparable	137
RDSITG2048-W	108757W	Comparable	29	RFG2-023-75	108103	Comparable	131
RDSOC2022K50	108849B	Comparable	34	RFG2-024-1	108518	Comparable	138, 195
RDSOC2027D-K	108850B	Comparable	34	RFG2-024-3	108519	Comparable	138, 196
RDSTTA2048-W	140984W	Close Comparable	10, 33	RFG2-026-2	108632	Comparable	115
RDSWTCLIP47DCI	108838	Comparable	41	RFG2-027-3	107093	Comparable	116
RDWBTF2002-C	108656	Comparable	41	RFG2-028-3	107092	Comparable	116
RDWBTF202D-C	108658	Comparable	41	RFG2-029-75	108101	Comparable	131
RDWBTF2047E-C	108657	Comparable	41	RFG2-030-1	108108	Comparable	119
RDWSTF2048-C	108680	Comparable	35	RFG2-031-1	108699	Comparable	120
RFAV-C16-K	107711B	Close Comparable	150	RFG2-034-3	108593	Comparable	122
RFAV-RN18-K	107712B	Close Comparable	150	RFG2-2496-6	108556	Comparable	148
RFAV-S16-K	107710B	Close Comparable	151	RFG2-BH22	110700	Comparable	237
RFAV-SA16-K	107718B	Close Comparable	151	RFG2-BH24	110701	Comparable	237

Questions regarding close comparables? Contact us for details/samples.

If you do not see a Kinter match for what you are looking for, please contact our Sales Department for a prompt quotation.

* Kinter's (K International, Inc.'s) parts are not manufactured by or connected in any way with siffron™.

"Comparable" is defined as "may not be identical to the siffron part, but generally corresponds to the siffron part and is suitable for the customer's intended use."

"Close Comparable" is defined as "generally corresponds to the siffron part and is suitable for the customer's intended use, but may be slightly different in dimensions, aesthetics, materials or function."

siffron™ Reference #	Kinter Item #	Match Type	Page #	siffron™ Reference #	Kinter Item #	Match Type	Page #
RF2-BH36	110702	Comparable	237	RLL-BF2WH-GF	107322	Comparable	56
RF2-BH48	110703	Comparable	237	RLL-BF3BK-GF	107323B	Comparable	56
RF2-WU-H100	106231	Comparable	107	RLL-BF3WH-GF	107323	Comparable	56
RF2-WU-H250	106232	Comparable	107	RLL-BF4BK-GF	107324B	Comparable	56
RF2-WU-NH100	106233	Comparable	107	RLL-BF4WH-GF	107324	Comparable	56
RF2-WU-NH250	106234	Comparable	107	RLL-BF5BK-GF	107325B	Comparable	56
RFLSH-MNT	107105	Comparable	206	RLL-BF5WH-GF	107325	Comparable	56
RFMT-1X1-2P	150681	Comparable	220	RLL-BF6BK-GF	107326B	Comparable	56
RFS3-10-2	109550	Comparable	48	RLL-BF6WH-GF	107326	Comparable	56
RFS3-4-2	109547	Comparable	48	RLL-BF7BK-GF	107327B	Comparable	56
RFS3-6-2	109548	Comparable	48	RLL-BF7WH-GF	107327	Comparable	56
RFS3-8-2	109549	Comparable	48	RLL-DH2BK-GF	107302B	Comparable	55
RFT-INS	105091	Close Comparable	224	RLL-DH2WH-GF	107302	Comparable	55
RFT-Q2-100-S	109500	Close Comparable	47	RLL-DH3BK-GF	107303B	Comparable	55
RHCH-48PVF060C	108602	Comparable	94	RLL-DH3WH-GF	107303	Comparable	55
RHT-1021-R	150250	Comparable	72	RLL-DH4BK-GF	107304B	Comparable	55
RHT-1091-SH	150251	Comparable	72	RLL-DH4WH-GF	107304	Comparable	55
RHT-1101	150260	Comparable	73	RLL-DH5BK-GF	107305B	Comparable	55
RHT-8001-WB	140402	Comparable	135	RLL-DH5WH-GF	107305	Comparable	55
RHT-8002-WB	140400	Comparable	135	RLL-DH6BK-GF	107306B	Comparable	55
RHT-8003-WB	140401	Comparable	135	RLL-DH6WH-GF	107306	Comparable	55
RHT-9001-CP	150220	Comparable	72	RLL-DH7WH-GF	107307	Comparable	55
RHT-9002-CP	150220	Close Comparable	72	RLL-DH8WH-GF	107308	Comparable	55
RICC20	107506W	Comparable	62	RMA-1321PA	106921	Comparable	105
RICC30	107507B	Comparable	62	RMA-1321PK	106921B	Comparable	105
RICT-2	107500	Close Comparable	62	RMA-1321UA	106903	Comparable	104
RICT-4	107501	Close Comparable	62	RMA-1321UK	106903B	Comparable	104
RIHC-10	107502	Comparable	61	RMD15030-3-14	140688	Comparable	67
RIHC-20	107503	Comparable	61	RMD15030-3-10	140109	Comparable	67
RIHC-30	107508B	Comparable	61	RMD15030-3-12	140110	Comparable	67
RIS-CBL-11	130506	Comparable	202	RMD-15030E-3-14	140689	Comparable	67
RIS-CBL-14	130507	Comparable	202	RMD15030-3-16	140111	Comparable	67
RIS-CBL-4	130500	Comparable	202	RMD15030-3-18	140112	Comparable	67
RIS-CBL-TIE	130504	Comparable	202	RMD15030-3-20	140113	Comparable	67
RJCH-48PVF060C	108600	Comparable	94	RMD15030-3-22	140114	Comparable	67
RJCH-48PVF125C	108601	Comparable	94	RMD15030-3-24	140115	Comparable	67
RJCH-48PVF250C	108631	Comparable	94	RMD15030-10	150000	Comparable	67
RKCH-7/8	107019	Comparable	259	RMD15030-12	150001	Comparable	67
RLL-BF2BK-GF	107322B	Comparable	56	RMD15030-14	150002	Comparable	67

Questions regarding close comparables? Contact us for details/samples.

If you do not see a Kinter match for what you are looking for, please contact our Sales Department for a prompt quotation.

* Kinter's (K International, Inc.'s) parts are not manufactured by or connected in any way with siffron™.

"Comparable" is defined as "may not be identical to the siffron part, but generally corresponds to the siffron part and is suitable for the customer's intended use."

"Close Comparable" is defined as "generally corresponds to the siffron part and is suitable for the customer's intended use, but may be slightly different in dimensions, aesthetics, materials or function."



siffron™ Reference #	Kinter Item #	Match Type	Page #	siffron™ Reference #	Kinter Item #	Match Type	Page #
RMD15030-16	150003	Comparable	67	RPH-205-3WH1000	107463	Comparable	59
RMD15030-18	150004	Comparable	67	RPH-205-4WH1000	107464	Comparable	59
RMD15030-20	150005	Comparable	67	RPH-205-6WH1000	107466	Comparable	59
RMD15030-22	150006	Comparable	67	RPH-205-8WH1000	107468	Comparable	59
RMD15030-24	150007	Comparable	67	RPH-20510WH1000	107468	Close Comparable	59
RMD-15030E-3-10	140116	Comparable	67	RPH-303-2WH250	107232	Comparable	55
RMD-15030E-3-12	140117	Comparable	67	RPH-303-3WH250	107233	Comparable	55
RMD-15030E-3-16	140118	Comparable	67	RPH-303-4WH250	107234	Comparable	55
RMD-15030E-3-18	140119	Comparable	67	RPH-303-6WH250	107236	Comparable	55
RMD-15030E-3-20	140120	Comparable	67	RPH-304-3WH250	107434	Close Comparable	55
RMD-15030E-3-22	140122	Comparable	67	RPH-304-4WH250	107434	Comparable	55
RMD-15030E-3-24	140124	Comparable	call for details	RPH-304-6WH250	107436	Comparable	55
RMD-15030E-10	150010	Comparable	126	RPH-305-2WH250	107262	Comparable	58
RMD-15030E-12	150011	Comparable	67	RPH-305-3WH250	107263	Comparable	58
RMD-15030E-14	150012	Comparable	67	RPH-305-4WH250	107264	Comparable	58
RMD-15030E-16	150013	Comparable	67	RPH-305-6WH250	107266	Comparable	58
RMD-15030E-18	150014	Comparable	67	RPH-305-8WH250	107268	Comparable	58
RMD-15030E-20	150015	Comparable	67	RPH-307-2WH250	107342	Comparable	60
RMD-15030E-22	150016	Comparable	67	RPH-307-4WH250	107344	Comparable	60
RMD-15030E-24	150017	Comparable	67	RPH-307-6WH250	107346	Comparable	60
RMF-48-C	140703	Comparable	68	RPH-308-4WH250	107284	Comparable	60
ROS-06	200016	Comparable	15, 64	RPH-308-6WH250	107286	Comparable	60
ROS-08	200018	Comparable	15, 64	RPHC-6	107046	Comparable	253
ROS-10	200020	Comparable	14, 64	RPM-21-A	106911	Comparable	103
RPDMP-65575	170966	Comparable	19, 82	RPOR-3/4	101027	Comparable	233
RPDMP-65595	170967	Comparable	19, 82	RPS-V2K-FSTNR	120401	Close Comparable	209
RPDMP-655115	170968	Comparable	19, 82	RPSR-12WM2	130200	Close Comparable	74
RPDMP-L21	150968	Comparable	19, 82	RQ-2	109502	Comparable	47
RPH-103-3WH1000	107363	Comparable	59	RQ-258	109595	Comparable	47
RPH-103-4WH1000	107364	Comparable	59	RRL-226	120300	Comparable	208
RPH-103-5WH1000	107365	Comparable	59	RRL-488	120302	Comparable	208
RPH-103-6WH1000	107366	Comparable	59	RRL-599	120303	Comparable	208
RPH-103-8WH1000	107366	Close Comparable	59	RRL-600	120305	Comparable	208, 239
RPH-203-2WH1000	107312	Comparable	59	RRL-833	120307	Comparable	208
RPH-203-3WH1000	107313	Comparable	59	RSAD-001-1	108500	Comparable	207
RPH-203-4WH1000	107314	Comparable	59	RSC-0001	150300	Comparable	157
RPH-203-6WH1000	107316	Comparable	59	RSC-0002	150303	Comparable	156
RPH-203-8WH1000	107316	Close Comparable	59	RSC-0003	150305	Close Comparable	156
RPH-205-2WH1000	107462	Comparable	59	RSC-0004K	150309	Close Comparable	157

Questions regarding close comparables? Contact us for details/samples.

If you do not see a Kinter match for what you are looking for, please contact our Sales Department for a prompt quotation.

* Kinter's (K International, Inc.'s) parts are not manufactured by or connected in any way with siffron™.

“Comparable” is defined as “may not be identical to the siffron part, but generally corresponds to the siffron part and is suitable for the customer’s intended use.”

“Close Comparable” is defined as “generally corresponds to the siffron part and is suitable for the customer’s intended use, but may be slightly different in dimensions, aesthetics, materials or function.”

siffron™ Reference #	Kinter Item #	Match Type	Page #	siffron™ Reference #	Kinter Item #	Match Type	Page #
RSC-0004W	150309	Comparable	157	RUS-3-SQTP	108743	Comparable	45
RSC-0005	150304	Comparable	156	RUSG-2-SQTP	108786	Comparable	46
RSC-0006	150305	Close Comparable	156	RWCH-12-092	108014	Comparable	256
RSC-0007	150301	Comparable	154	RWCH-16-092	108015	Comparable	256
RSC-0008	150302	Comparable	154	RWCH-24-092	108018	Comparable	256
RSC-0009	150308	Close Comparable	158	RWCH-36-092	108021	Comparable	256
RSC-0013	150313	Comparable	158	RWCH-4-092	108010	Comparable	256
RSC-0014	150307	Comparable	158	RWCH-6-092	108011	Comparable	256
RSC-0015	150306	Comparable	159	RWCH-8-092	108012	Comparable	256
RSC-0017	150310	Comparable	157	RWLM-2	107212	Comparable	42
RSL-LP01	109626	Comparable	14, 63	RWLM-3	107207	Comparable	42
RSL-ML01	109526	Comparable	63	RWLR-1-P	101001	Comparable	231
RSL-ML01-K	109526B	Comparable	63	S01-SH-CTB3	150837	Close Comparable	179
RSL-ML01-W	109526	Close Comparable	63	S01-SH-CTB8	150145	Comparable	178
RSL-MLKY	109527	Comparable	63	S01-SH-N1185	150166	Comparable	178
RSPC-FP-H11	150164	Close Comparable	126	S01-SH-N8555	150165	Close Comparable	178
RSPC-FP-H5	150160	Comparable	126	S01-SH-OTB7	150143	Comparable	179
RSPC-MP-H11	150164	Close Comparable	126	S01-SH-OTB8	150144	Comparable	179
RSPC-MP-H5	150123	Comparable	126	S01-SH-SLB2	150801	Comparable	179
RSPC-SH-H5	108681	Comparable	33	S01-SH-SLB4	150802	Comparable	179
RTP-LG	107061	Comparable	251	S01-SH-SLB7	150803	Comparable	179
RTP-SM	107060	Comparable	251	S01-SH-SLB8	150808	Comparable	179
RTSA-12-2	130200	Close Comparable	74	R40-111-4BXA	181518	Comparable	18, 81
RTSA-12-3	130200	Close Comparable	74	R40-111-2BX	181518S	Comparable	18, 81
RUCB-1-48-C	180200	Comparable	14, 54	R40-111-4BX	181518S	Comparable	18, 81
RUS-2-SQTP	108742	Comparable	45	R40-JMK	181522	Comparable	18, 81
RUS-2-TP	108697	Comparable	46	R-WSB21	150439	Close Comparable	90
RUS-250-SQTP	108810	Comparable	45				

Questions regarding close comparables? Contact us for details/samples.

If you do not see a Kinter match for what you are looking for, please contact our Sales Department for a prompt quotation.

* Kinter's (K International, Inc.'s) parts are not manufactured by or connected in any way with siffron™.

"Comparable" is defined as "may not be identical to the siffron part, but generally corresponds to the siffron part and is suitable for the customer's intended use."

"Close Comparable" is defined as "generally corresponds to the siffron part and is suitable for the customer's intended use, but may be slightly different in dimensions, aesthetics, materials or function."

ITEM	PAGE #	ITEM	PAGE #
360 Degree Trapeze Banner Hanger Adapter Kit	287	BetterView Adapter For Shelf Channel	143
Acrylic Slantback Sign Holder	179	BetterView Adapter For Wire & Corrugated	143
Acrylic Top-Load Sign Holder	179	BetterView Ratcheting Sign Holders	143
Acrylic Wall-Mount Sign Holder	172	BetterView Shovel Base Adapters	143
Adhesive Ceiling Loop	260	Beverage Shelf Extender	71
Adhesive Clip-On Knuckle Sign Holder	158	Bit Snap Link	234
Adhesive Strap Clip	201	Black Aluminum Binder Post & Screws 8-32	227
Adhesive Wire Grid Sign Holder	25, 139	Boot System Adhesive Base	98
Adhesive Wire/Pen Clip	140	Boot System Contoured Adhesive Base	98
Adjustable Pallet Guard	196	Boot System Gondola Top Gripper Base	99
Adjustable Trapeze Banner Hanger System	287	Boot System Heavy Duty Gripper Poster Channel	99
Aisle Sign Arm Hanger – Adjustable Hook	151	Boot System Magnetic Base	98
Aisle Sign Arm Hanger – Arched	150	Boot System Thin Poster Channel	99
Aisle Sign Arm Hanger – Curved	150	Branched Multi-Cord Ceiling Clips	253
Aisle Sign Arm Hanger – Shepherd	150	Brass Binder Post & Screws 8-32	227
Aisle Sign Arm Hanger – Straight	151	Brass Wire Mobile Hanger & Cord	252
Alcohol Swab	220	Bucket Clip Track Sign Holder	39, 142
All Purpose Adhesive Clip	139	Budget Banner Hanger/Stabilizer	247
All-Wire Pegboard Hook With Gripper	61	Budget “U” Channel Gripper Sign Holder	194
All-Wire Pegboard Hook With Scan Hook	50	Bullet Style Cable Adjuster	268
All-Wire Pegboard Hook With Scan Plate	50	Bullet Style Cable & Adjuster Kits	268
All-Wire Pegboard Hook With T-Scan Bar	50	Bumper Buttons	221
Aluminum Banner Joiner Hanger Clip	239	Business Card Holder	173
Aluminum Binder Post Extensions 8-32	226	Business Card Holder For Pegboard/Slatwall	26, 173
Aluminum Binder Post & Screws 8-32	226	Butterfly Corrugated/Wire Combo Display Hooks	59
Aluminum Ceiling Hook	259	Butterfly Display Hooks	56
Aluminum Roller Hook	231	Butterfly Hook Product Stop	61
Aluminum Twist Sign Holder	134	Cable & Adjuster Kits	271
Angled Double Wire Shelf Info Strip	34	Cable Sleeves (Crimps)	266
Angled Economy Info Strip Label Holder	29	Cable Ties (Locking Straps)	202
Angled Info Strip With Gripper	30	C-Channel for Metro® Shelving	12, 40
Angled Tag Molding	36	“C” Channel Shelf Molding	37, 94
Anti-Skid Divider	69	“C” Clamp Bracket	21, 109
Anti-Sweep Metal Hook With T-Scan Bar	14, 64	“C” Clamp Gripper Aisle Sign Holder	100
Atlas Banner Hanger	236	Ceiling Fan Sign Gripper	120
Banner Hanger Clip	236	Ceiling Hook & Cord	253
Banner Hanger Clip With Hook	237	Ceiling Swivel Loop Clip	260
Banner Hanger Track End Cap Retainer	248	Ceiling Twist Clip & Cord	253
Barbed Cords	254	Ceiling Twist Hook	258
Basket For Newspaper & Ad Stand Sign Holder	90	Ceiling Twist Loop	258
Beaded Chain	273	Ceiling Twist Side Exit Cable Adjuster	262, 270
Beaded Chain Accessories	273	Center Shelf Mount Covered-Face Sign Holder	127
Beaded Chain Assemblies	273	Channel-Mount Arm Hanger – Curved	150
Below Shelf Sign Holder	33	Channel Mount Arrow Fastener	124

ITEM	PAGE #	ITEM	PAGE #
Channel Mount Bracket	21, 109	Covered Face Channel With Adhesive	128
Channel Mount Gripper Sign Holder	101	Crystal Easel Ticket Holder	167
Channel Mount Gripper Sign Holder – Metal	101	Crystal Glass Shelf Ticket Holder	44
Channel Mount Spring Wobbler	134	Crystal Ticket Holder	44
Channel Mount Swivel Gripper	101	Crystal Wood Shelf Ticket Holder	44
Channel Mount Track Sign Holder	39	Curl Back Crossbar Hook	13, 54
Channel Mount With Adhesive	124	Dart (Arrow) Clip Fastener	212
Channel Wobbler Sign Holder	135	Dart Clip – Small	211
Chip Strip For Price Channel	31	Delta Hole Hang Tab – Bulk	72
Circular Hole Hang Tab – Sheet Form	73	Delta Hole Hang Tab – Sheet Form	72
Clear Display Hanger Strip	135	Diamond Hole Shelf Dart Clip	211
Clear Hinged Ceiling Hook	259	Diamond Hole Shelf Push-In Clip	211
Clear Power Wire Wing Clip	204	Display Caster With Adhesive	197
Clear Tabletop Bin	18, 82	Display Hook Product Stop	61
Clear UPC Tag Holder	41	Display Poles	198
Clever Clip Suction Cup	159	Double Barbed Graphic Fastener	243, 245
“C” Links	257	Double “C” Channel With Holes	11, 37
Clip For P.O.P. Sign Holder	41	Double “C” Hooks	256
Clip-On “C” Channel Label Holder	12, 40	Double Clip-On Curly Wire	157
Clip-On Ceiling Loop	260	Double Clip-On Knuckle Sign Holder	157
Clip-On Corrugated Shelf Supports	188	Double Curved “C” Channel For Shelf Channel	30
Clip-On Info Strip Label Holder	33	Double End X-Mas Tree Fastener	212
Clip-On Knuckle Sign Holder	156	Double Magnetic Adapter Base For Aisle Sign Arms	153
Clip-On Knuckle Wire Sign Holder	158	Double Merchandising Strip Hanger	77
Clip-On Sign Protector	155	Double “S” Hook	79
Clip-On Track Sign Channel	38	Double-Sided Peg Hook Strip	73
Combination Economy Wrench	223	Double-Sided Pre-Cut Foam Tape	220
Conduit Support Tube Hanging Clip	250	Double Suction Cup With Flag Gripper	160
Contoured Front Fence	69	Double Wire Shelf “C” Channel	35
Contoured Low Profile Front Fence	69	Double Wire Shelf Info Strip	34
Contoured Magnetic Back Shelf Gripper	68	Dual-Purpose Flip-Up Label Holder	12, 45
Contoured Shelf Divider	68	Dual-Purpose Info Strip Label Holder For Slotted Shelf	35
Corrugated Edge Molding	190	Easel Back Sign Holder	179
Corrugated Shelf Support Inserts	189	Easel Card Holder	168
Corrugated Tapered Back Display Hooks	55	Easel Card Holder – Angled	167
Corrugated Universal Butterfly Display Hooks	56	Easel Card Holder – Elevated Angled	168
Corrugated Universal Display Hooks	58	Easel Track Sign Holder	168
Corrugated Universal Display Hooks With “C” Channel	57	Easy-Flex Channel Mount Arrow Fastener	124
Corrugated Universal Display Hooks With Scan Plate	57	Easy-Flex Shelf Channel Sign Holder	124
Corrugated Universal Display Hooks With T-Scan Bar	57	Easy-Off Fastener & Label Remover Tool – Plastic	224
Corrugated/Wire Combo Display Hooks	59	Economy Card Holder	166
Corrugated/Wire Combo Display Hooks With “C” Channel	58	Economy “C” Channel Shelf Molding	11, 37, 93
Corrugated/Wire Combo Display Hooks With Scan Plate	58	Economy Covered-Face Center Mount Sign Holder	127
Counter Mat Sign Holder	87	Economy Fastener & Label Remover Tool	224

ITEM	PAGE #	ITEM	PAGE #
Economy Hand Swager	26, 274	Fold-Up Easel Back Literature Box	175
Economy Info Strip Flush Sign Holder	121	Fold-Up Rigid Literature Holder	174
Economy Info Strip Hinged Flush Sign Holder	120	Four-Level Brochure Holder	177
Economy Screwdrivers	223, 291	Four-Wire Label Holder For Scan Hooks	47
Economy Squeegee Applicator	169	Four-Wire Top Insert Label Holder For Scan Hooks	47
Economy Suction Cup With Flag Gripper	161	Freestanding Sign Holder With Business Card Pocket	178
Economy Suction Cup With Flush Gripper	161	Freestanding Sign Holder With Pocket	177
Elastic Barbed Cords	255	Freestanding Sign Holder With Spring Clip	165
Elliptical Banner Hanger – Aluminum	238	Front Load Plastic Sign Frame Rail	95
Elliptical Banner Hanger Clip	238, 240	Garment Display Hanger	151
Elliptical Banner Hanger – Plastic	240	Gondola Top Gripper Sign Holder	148
Elliptical End Cap	238	Gondola Upright Bracket	24, 112
Expand-A-Lock Connector	210	Gondola Upright Gripper Sign Holder	106
Extra Duty Info Strip Label Holder For Wire Basket	41	Gondola Upright “Offset” Gripper Sign Holder	20, 106
Extra Heavy Duty Magnetic Adapter	217	Goose Neck Telescopic Sign Holder With Spring Clip	26, 164
Extra Heavy-Duty Magnetic Hook	80, 261	Gourmet Clip Tag Holder	144
Extra Height Adjustable Pallet Sign Holder	89	Graphic Ratchet Fastener	239
Extra-Large Winged Back Literature Holder With Hole	176	Grid Ceiling Spanner Bar	262
Extruded Front Fence	69	Grip-On Gripper Info Strip	11, 36
Extruded Hinge With Adhesive	195	Gripper 60 Degree Panel Former	192
Fastener & Label Remover Tool	224	Gripper 60 Degree Two-Way Panel Former	194
Figure “8” Squeeze Clip	263	Gripper 90 Degree Four-Way Panel Former	194
Five Cavity Heavy Duty Swager	274	Gripper 90 Degree Panel Former	192
Fixed Style Cable End – Snap Hook	267	Gripper 90 Degree Two-Way Panel Former	194
Fixed Style Security Tie	203	Gripper 180 Degree “H” Panel Former	192
Flexible Display Foot	196	Gripper Apollo Banner Hanger	237
Flexible Magnetic “C” Channel	40	Gripper Apollo Banner Hanger With Adhesive	95
Flexible Magnets	218	Gripper Apollo Banner Hanger With Suction Cups	96
Flip Info Strip Gripper Label Holder For T-Scan Hook	46	Gripper Apollo Designer Series Banner Hanger	237
Flip Info Strip Label Holder For T-Scan Hook	45	Gripper Apollo Insert	239
Flip-Up “C” Channel Header	32	Gripper Atlas Banner Hanger	236
Flip-Up Covered Face Sign Holder	32	Gripper Budget Banner Hanger/Stabilizer	247
Flip-Up Double-Slot Sign Holder	32	Gripper Covered-Face Sign Holder	118
Flip-Up Double Wire Shelf Info Strip With “C” Channel	34	Gripper Covered-Face Sign Holder/Protector	119
Flip-Up Pallet Tag	32	Gripper Display Sign Holder	193
Flip-Up Snap-In Info Strip	31	Gripper Display Tracks	36
Floor Stand Corner Glide	196	Gripper Dual Action Flag Sign Holder	130
Floor Stand With Sign Frame & Bag Stem	89	Gripper Dual Panel Holder	193
Floor Stand With Welded Top Sign	89	Gripper Extended Sign Holder	132
Floral Stand With Bucket Holder	18, 81	Gripper Flip-Up Flush Sign Holder	122
Flush Mount Adapter With Adhesive	146	Gripper Flip-Up Info Strip Label Holder For Scan Hooks	45
Flush Sign Holder	95	Gripper Flush Sign Holder	122
Flute Wire	190	Gripper Flush Sign Holder For Slatwall	206
Foam Block Stand-Off	221, 284	Gripper Gondola Upright Header	97

ITEM	PAGE #	ITEM	PAGE #
Gripper "H" Clip	138, 195	Hinged "C" Channel Covered-Face Sign Holder	127
Gripper Hinged Flag Sign Holder For Wire	138	Hinged Gripper Concealed Panel Former	193
Gripper Hinged Flush Sign Holder For Wire	138	Hinged Gripper Flag Sign Holder	133
Gripper "H" Sign Holder	138, 195	Hinged Gripper Flush Mount Sign Holder	118
Gripper Long Leg Shelf Channel Sign Holder	123	Hinged Gripper Flush Sign Holder	119
Gripper L-Style Table Top Sign Holder	166	Hinged Gripper Offset Sign Holder	146
Gripper Scan Plate Flag Holder	133	Hinged Gripper Panel Former	193
Gripper Shelf Channel Sign Holder	123	Hinged Gripper Sign Holder	115
Gripper Shovel Base Sign Holder	118	Hinged Gripper Square Edge Sign Holder	148
Gripper Sign Holder	114	Hinged Gripper Square Shelf Flag Sign Holder	133
Gripper Sign Holder For Display Poles	199	Hinged Gripper Square Shelf Flush Sign Holder	119
Gripper Sign Holder Insert	239, 242, 245	Hinged Snap Rings	232
Gripper Simple Banner Hanger	246	Hinged "U" Channel Gripper Sign Holder	121
Gripper Square Bin Flush Sign Holder	120	Hook & Loop Fasteners	219
Gripper Square Edge Sign Holder	148	Indoor/Outdoor Sign-Mounting Bracket Kit	201
Gripper Square Shelf Flush Sign Holder	119	Indoor/Outdoor Spring Base Floor Stand	91
Gripper T-Style Table Top Sign Holder	115	Info Strip Flag Sign Holder	132
Gripper Twist-In Sign Holder	128	Info Strip For Cooler/Freezer Shelving	35
Gripper "U" Channel Panel Former	192	Info Strip For Glass Shelving	11, 36
Gripper UPC Tag/Sign Holder	123	Info Strip Gripper Flag Sign Holder	131
Gripper Warehouse Upright Header	97	Info Strip Gripper Label Holder For Scan Hook	13, 46
Gripper Wire Flag Sign Holder	137	Info Strip Hinged Angled Style Universal Flag Sign Holder	131
Gripper Wire Flush Sign Holder	137	Info Strip Hinged Gripper Flag Sign Holder	131
Gripper Wire Grid Sign Holder	136	Info Strip Hinged Universal Flag Sign Holder	131
Hanging Coil	263	Info Strip Label Holder For Metal Scan Plate	46
Harp Clip Sign Holder	164	Info Strip Label Holder For Multiple Scan Hooks	45
"H" Channel With Adhesive	94	Info Strip Label Holder For Scan Hook	47
Heavy Duty Clip-On Extended Knuckle Sign Holder	156	Info Strip Label Holder For Small Scan Plate	46
Heavy Duty Clip-On Knuckle Sign Holder	156	Info Strip Label Holder For Wood Shelving	35
Heavy Duty Corrugated Shelf Support Inserts	189	Info Strip Multi-Position Flag Sign Holder	132
Heavy Duty Expand-A-Lock	210	Info Strip Universal Flush Sign Holder	120
Heavy Duty Gripper Flush Sign Holder	122	Installation Poles	264
Heavy Duty Gripper Sign Holder – Extra Wide	114	Instant Flag Angled Display Base	149
Heavy Duty Gripper Sign Holder – Narrow	114	Instant Flag Gripper Display Tube	149
Heavy Duty Gripper Sign Holder – Wide	114	Instant Flag Slatwall/Pegboard Display Base	148
Heavy Duty Magnetic Adapter	217	Instant Flag Slitted Display Tube	149
Heavy Duty Magnetic Hook	261	Inventory Control Tube	62
Heavy-Duty Pegboard Hook Overlay	13, 48	Inventory Control Unit	62
Heavy Duty Power Wire Wing Clip	204	"J" Channel With Adhesive	94
Heavy Duty Round Graphic/Banner Joiner	243	"J" Hook Wire Sign Holder	139
Heavy Duty Self-Adhesive Info Strips	28	"J" Hook With Adhesive	260
Heavy Duty Self-Piercing Channel Flag Holder	129	K-Ads® Billboard Suction Cup Sign Holder	113
Heavy Duty "S" Hook	79	K-Ads® Shopping Cart Sign Frame	87
Heavy Duty Telescopic Clip-On Sign Holder	154	K-Frame Adhesive Holders	183

ITEM	PAGE #	ITEM	PAGE #
K-Frame Adjustable Magnetic Rotating Holder	185	Ladderless Magnetic "C" Channel Wall Banner Hanger	281
K-Frame "C" Clamp Aisle Holder	183	Ladderless Magnetic Gripper Apollo Banner Hanger	279
K-Frame Channel Mount Holders	183	Ladderless Magnetic Gripper Apollo Wall Banner Hanger	282
K-Frame Clip-On Rotating Thumb Sign Holder	186	Ladderless Magnetic Gripper Banner Hanger	279
K-Frame Gondola Upright Holder	182	Ladderless Magnetic Gripper Wall Banner Hanger	282
K-Frame Hanger Clip	186	Ladderless Mounting Plate Hardware Kits	291
K-Frame Magnetic Holders	184	Ladderless Mounting Plates	290
K-Frame Magnetic Shelf-Top Holder	185	Ladderless Mounting Plate Stud Screw	290
K-Frame Magnetic Under-Shelf Holder	184	Ladderless Mounting Strip	288
K-Frame Magnetic Under-Shelf L-Style Holder	184	Ladderless Multi-Use Hanger Clip	289
K-Frame Pegboard Holder	182	Ladderless Stackable "C" Channel Sign Board	283
K-Frames	181	Ladderless Stackable Spiral Sign Board	283
K-Frame Shelf-Top Holders	183	Ladderless Toggle Screw Mounting Plate Anchor	290
K-Frame Shovel Base	185	Ladder Style Permanent Locking Straps	203
K-Frame Shovel Bases With Adjustable Stem	185	"L" Bracket	195
K-Frame Suction Cup Holders	182	Legged Snap-In Info Strip	30
K-Frame Telescopic Aisle Holders	182	Literature Pockets	174
K-Frame Telescopic Clip-On Holder	185	Looped End Cable Assemblies	267
K-Frame Under-Shelf Hardware-Mount Holder	184	Looping Cable Adjuster	270
K-Frame Under-Shelf Holders	184	Loop Style Locking Strap	203
K-Frame Wall Mount Holder Kit	182	"L" Style Sign Holder With Adhesive	166
K-Frame Warehouse Upright Holder	183	Magnetic Adapter	216
K-Frame Wire Flush Hanger Clip	186	Magnetic Adapter With Adhesive	216
K-Lock® Security Tethers – Standard Duty	16, 66	Magnetic Adjustable Double-Hook Aisle Sign Arm	151
K-Stick® Ladderless Pole	277	Magnetic Ceiling Loop	261
Label Holder For Cooler/Freezer Shelf Channel	30	Magnetic Clamp With Adhesive	96
Label Holder For Double Wire Shelf	43	Magnetic Clamp With Adhesive – Heavy Duty	96
Label Holder For Wire Fixtures	42	Magnetic Clip-On Curly Wire	157
Ladderless 360 Degree Hook Banner Hanger	286	Magnetic Clip-On Knuckle Wire Sign Holder	158
Ladderless 360 Degree Magnetic Banner Hanger	278	Magnetic Flush-Style Adapter Base For Aisle Sign Arms	153
Ladderless Binder Cleat Wall Banner Hanger	284	Magnetic Gripper Flag Sign Holder	117
Ladderless Block End Hooks	289	Magnetic Gripper Flush Sign Holder	117
Ladderless "C" Channel Cleat Wall Banner Hanger	285	Magnetic Gripper Flush Sign Holder – Light Duty	117
Ladderless "C" Channel Clip & Cord	288	Magnetic Gripper Offset Sign Holder	117
Ladderless Cleat Banner Hanger For Glass	285	Magnetic Gripper Sign Holder	116
Ladderless Drill Bits	291	Magnetic Gripper Sign Holder – Extra Tall	116
Ladderless End Cap Retainer	289	Magnetic Gripper Sign Holder – Light Duty	116
Ladderless Hook Banner Hanger	286	Magnetic Hooks	80, 261
Ladderless Hook Banner Hanger – Heavy Duty	286	Magnetic Key For Stop Locks	63
Ladderless Magnetic Atlas Banner Hanger	280	Magnetic Ladderless Ceiling Clip & Cord	280
Ladderless Magnetic Atlas Wall Banner Hanger	282	Magnetic Ladderless Ceiling Clip With Holes	280
Ladderless Magnetic Banner Hanger	278	Magnetic Ladderless Ceiling Clothes Hanger Adapter	281
Ladderless Magnetic Banner Hanger – Heavy Duty	278	Magnetic Non-Tip Under-Shelf Gripper Sign Holder	103
Ladderless Magnetic "C" Channel Banner Hanger	279	Magnetic Shelf System – Divider	67

ITEM	PAGE #	ITEM	PAGE #
Magnetic Shelf System – End Cap	67	One-Piece Folding Aluminum Ceiling Hook	259
Magnetic Shelf System – Front Fence	68	Opti-Bins & Label Holder	19, 82
Magnetic Shelf-Top Gripper Sign Holder	102	Outdoor Lawn Sign Frame	91
Magnetic Sign Stand Adapter	153	Packaging Handles	191
Magnetic Under-Shelf Bracket	22, 110	Pallet Display Clip	191
Magnetic Under-Shelf Bracket – L-Style	22, 109	Pallet Sign Holder – Adjustable Height	88
Magnetic Under-Shelf Gripper Sign Holder	102	Pear Clips	231
Magnetic Under-Shelf Gripper Sign Holder – L-Style	102	Pegboard Bracket	23, 111
Merchandising Strip Hanger For Cooler Door	76	Pegboard Gripper Sign Holder	106
Merchandising Strip With Removable Header	74	Pegboard Hook Overlays	48
Metal Adapter For Crossbar & Wire Grids	152	Pegboard Paper/Vinyl Fastener	209
Metal Adjustable Shelf Extender	71	Pegboard/Slatwall Adapter	207
Metal Ceiling Twist Loop	262	Pegboard/Slatwall Adapter For Aisle Sign Arms	152
Metal Ceiling Twist Stud	262	Pegboard/Slatwall Display Hooks	59
Metal Jack Chain	272	Pegboard/Slatwall Display Hooks With “C” Channel	60
Metal Jack Chain Kit	272	Pegboard/Slatwall Display Hooks With Scan Plate	60
Metal Merchandising Strips	76	Pegboard/Slatwall Display Hooks With T-Scan Bar	60
Metal Mini Shelf Channel Adapter With Screw	125	Pegboard/Slatwall Plastic Back Adapter	53
Metal Power Wire Wing Clip	205	Pegboard/Slatwall Power Wing Clip	206
Metal Power Wire Wing Clip – Large Style	205	Peg Hook Product Stop	61
Metal Shelf Channel Adapter With Screw	125	Perforated Merchandising Strip	74
Metal Shelf-Top Bracket	21, 78, 108	Perf Shelf Channel Fastener	211
Metal Sign Frame – Adjustable Stem	86	Perf Shelf Dart Clip	211
Metal Sign Frame – Fixed Stem	86	Perf Shelf Flush Sign Holder With Adhesive	122
Metal Sign Frame – Magnetic Base	87	Perf Shelf Gripper Flag Sign Holder	129
Metal Sign Frame – No Stem	86	Perf Shelf Gripper Flush Sign Holder	121
Metal Squeeze Clip & Cord	252	Perf Shelf Plastic Loop Fastener	209
Metal Telescopic Bracket	23, 111	Perf Shelf “S” Hooks	79
Metal Vinyl Graphic Banner Rod System	250	Perf Shelf Universal Fasteners	210
Mid-Channel Mount Sign Protectors	126	Perf Shelf White Snap Rivet	210
Mini “Stick-On” Tag	10, 31	Perpendicular Gripper Sign Holder	25, 147
Mobile Springs	255	Pigtail Hook Side Exit Cable Adjuster	269
Modified Snap-In Info Strip	29	Pin-Up Hook	54
Modular Display Pole Shelf Support	199	Plastic Banner Dowel Rod	288
Modular Display Pole Shelf Support Cap	199	Plastic Double “C” Hooks – Locking Ends	256
Molded Plastic Display Feet Kit	198	Plastic Double “C” Hooks – Open Ends	256
Multi-Mount Covered-Face Sign Holder	127	Plastic Grid Clip With Hole	259
Multi-Purpose Formed Style Label Holder	42	Plastic Master Display Caster	197
Multi-Purpose Sign Holder	145	Plastic Modular Sign Frame System	84
Narrow Double-Wire Shelf Info Strip	10, 34	Plastic Oval Snap Ring	234
Newspaper & Ad Stand Sign Holder	90	Plastic Overlap Ring	233
Non-Scratch Magnetic Insert	216	Plastic “S” Hook Merchandiser	80
Notched Gripper Wire Flag Sign Holder	137	Plastic Sign Frame – Adjustable Stem	85
Notched Gripper Wire Flush Sign Holder	136	Plastic Sign Frame – Shovel Base	85

ITEM	PAGE #	ITEM	PAGE #
Plastic Snap Ring	233	Round Magnetic Adapter	218
Plastic Spiral Ring	233	Round Neo Disk Magnet	218
Plastic Vinyl Graphic Banner Dowel Rod	248	Round or Square Economy Banner Joiner	243, 245
Pole Gripper	200	Screw Lock Rings	232
Pole Gripper Sign Holder	200	Security Peg Back Lock	15, 64
Pole Sign Cable Tie Kits	201	Self-Adhesive Gripper Info Strip	28
P.O.P. Sign Holder With Clips	41	Self-Adhesive Info Strips	28
Poster Frame Floor Display Stand	90	Self-Adhesive Info Strip With Guidebar	28
Power Panel Bar	203	Self-Adhesive Track Sign Channel	38
Power Wire Wing Clip	204	Self-Piercing Channel Flag Holder	129
Power Wire Wing Clip – Long Style	204	Self-Piercing Channel Flush Holder	123
Premium Graphic Board Floor Stand	91	Self-Piercing Covered Ticket Holder	42
Premium Pole Gripper – Flush	200	Self-Piercing Flag Sign Holder	129
Premium Suction Cup – Metal Hook	162	Self-Piercing Flush Sign Holder	121
Premium Suction Cup – Mushroom Head	162	Self-Piercing Suction Cup Flag Sign Holder	161
Premium Suction Cup – Pilot Hole	162	Self-Piercing Wire Flush Sign Holder	136
Price Channel Gripper Flag Sign Holder	130	Self-Sticking Cardboard Easel	180
Price Channel Sign Holder	130	Serpentine Metal Shelf Extender	71
Print Protectors	169	Shelf Channel Adapter With Screw	125
Produce Bin Overhanging Sign Frame	142	Shelf Extender Clip	78
Quadway Mobile Kit	251	Shelf Support Clips	188
Quick-Grip Washer Fastener	209	Shelf-Top Adhesive Info Strips	10, 33
Quick-Strip Molded Merchandising Strip	75	Shelf-Top Bracket	21, 108
Quick-Strip Molded Merchandising Strip With Header	75	Shelf-Top Flag Sign Holder	128
Rapid Assembly Plastic Binder Post & Screws 10-24	230	Shelf-Top Gripper Sign Holder	100
Ratchet Rivet Fastener	208	Shelf-Top Gripper Sign Holder – Metal	100
Ratchet-Style Deli Sign Clip	144	Shelf-Top Hook For Flag Or Flush Merchandising	77
R-Clip With Adhesive	25, 139	Shelf-Top Merchandising Strip Hanger – Plastic	78
Rectangular Neo Magnet With Adhesive	217	Shelf-Top Metal Merchandising Strips	17, 76
Releasable Beaded Locking Straps	202	Shelf-Top Swivel Merchandising Strip Hanger	78
Re-Order Hanging Label Holder	73	Shoe Clip Sign Holder	145
Re-Order Peg Back Label Holder	73	“S” Hooks	79, 257, 271
Rigid Covered Sign Holder With Holes	172	Side Insert Label Holder For Scan Hook	48
Rigid Display Feet	196	Sign Board Pallet Sign Holder – Adjustable Height	88
Rigid Freestanding Literature Holder	174	Simple Banner Hanger	246
Rigid Wall Mount Coupon Holder	173	Single End Economy Wrenches	223
Rigid Wall Mount Literature Holder	174	Single Jack Chain Lengths	272
Ring Handles	232	Single-Pocket Winged Back Literature Holder	175
Roller Style Pear Clip	231	Single-Pocket Winged Back Literature Holder With Hole	175
Rotatable Gripper Sign Holder	115	Single Prong All-Wire Pegboard Hook	51
Round Graphic/Banner End Cap	242	Single Prong Metal Grid Hook	54
Round Graphic/Banner Hanger	242	Single Prong Plastic Back Metal Pegboard Hook	53
Round Graphic/Banner Hanger Clip	242	Slantback Fold-Up Sign Holder	178
Round Inventory Control Unit	62	Slatwall Adapter With Adhesive	207

ITEM	PAGE #	ITEM	PAGE #
Slatwall Bracket	24, 111	Stackable Push-In Fastener	283
Slatwall Gripper Sign Holder	106	Stainless Steel Barrel Bolts & Screws 10-24	229
Slatwall Power Wing Clip	206	Stainless Steel Binder Post & Screws 8-32	228
Slide-On Gripper Sign Holders	20, 108	Stainless Steel Pan Clip	145
Slim-Line Dual Mount Sign Protector	126	Static Cling Print Protector	169
Slim-Line Front Fence	70	Steel Barrel Bolt Extension 10-24	229
Slim-Line Oversized Sign Protector	126	Steel Barrel Bolts & Screws 1/4-20	230
Slim-Line Shelf Divider	70	Steel Barrel Bolts & Screws 10-24	229
Slim-Line Sign Protector	126	Steel Binder Post & Screws 8-32	228
Snap-Down Metal Sign Frame	85	Steel Cable	266
Snap Hook Bottom Exit Cable Adjuster	269	Steel Cable (Wire Rope) Cutter	274
Snap-In Gripper Info Strip	29	Stop Lock For Loop Hooks	14, 63
Snap-In Info Strip	29	Stop Lock For Stem Hooks	63
Snap-Lock Ceiling Clip & Cord	252	Suction Cup Clip-On Knuckle Wire Sign Holder	159
Snap Rivet Fastener	208	Suction Cup With Flag Gripper	160
Snap-Shut Banner Hanger	246	Suction Cup With Flush Gripper	160
Snap-Shut Label Holder For Scan Hook	47	Suction Cup With Metal Screw	163
Solid Contoured Shelf Divider	17, 70	Suction Cup With Thumb Screw	163
Space General Banner Hanger	241	Suction Cup With Thumbtack	163
Space General End Cap	241	Swivel Ceiling Grid Clip	258
Space General Hanger Clip	241	Swivel Display Caster With Corner Bracket	197
Space General Hanger Clip With Hook	241	Swiveling Clever Clip	140
Speedy-Back Adapter For Straight Entry Metal Hook	52	Swiveling Clever Clip – Jumbo	140
Speedy-Back Metal Peg Hook With Scan Hook	51	Swivel Snail Disk With Adhesive	263
Speedy-Back Metal Peg Hook With T-Scan Bar	52	Synthetic Wicker Basket	19, 82
Spiral Base Card Holder	164	Table Top Card Holder	166
Spiral “Break-Away” Sign Holder	93	Take-One Metal Hook With T-Scan Bar	15, 64
Spiral Cone Card Holder	165	Take-One Outdoor Literature Holder	180
Spiral Dual-Channel Sign Holder	93	Tapered Display Hooks With “C” Channel	55
Spiral Sign Board	92, 250	Tapered Display Hooks With Scan Plate	55
Spiral Sign Board Brackets	92	Tapered Display Hooks With T-Scan Bar	56
Spiral Sign Board Pads	92	Telescopic Double-Hook Aisle Sign Holder – Gondola	105
Spring Clip-On Extended Knuckle Sign Holder	154	Telescopic Double-Hook Aisle Sign Holder – Pegboard/Slatwall	105
Spring Clip-On Knuckle Sign Holder	154	Telescopic Gripper Aisle Sign Holder – Gondola	104
Spring Clip-On Rotating Thumb Sign Holder	155	Telescopic Gripper Aisle Sign Holder – Pegboard	105
Spring Clip-On Track Sign Holder	39, 144	Threaded Extension Pole	264
Spring Clip-On Two-Way Ratcheting Sign Holder	155	Threaded Side Exit Cable Adjuster	269
Spring Wobbler	134	Three Cavity Hand Swager	274
Square Edge Power Wing Clip	206	Three-Level Brochure Holder	177
Square Graphic/Banner End Cap	244	Three-Level Merchandise Floor Bin	17, 81
Square Graphic/Banner Hanger	244	Thumbsnap Fastener	209
Square Graphic/Banner Hanger Clip	244	Ticket Holder For Wire Fixtures	42
Squeeze Clip	263	Toggler® Anchor	222
Squeeze Style Inventory Control Unit	62	Tool-Free Telescopic Gripper Aisle Sign Holder – Gondola	104

ITEM	PAGE #	ITEM	PAGE #
Top Sign Holder For Display Poles	199	Vinyl Pouch With Magnetic Strips	171
Track Sign Channel With Bonus Slot	38	Vinyl Pouch With Side Opening	170
Track Sign Holders With Ratcheting Heads	141	Vinyl Pouch With Two Mounting Holes	170
Triway Mobile Kit	251	Wall Anchor – Heavy Duty Toggle Wing	222
T-Style Bottom-Load Sign Holder	178	Wall Anchor – Light Duty Conical	222
T-Style Sign Holder With Business Card Pocket	178	Wall Anchor – Medium Duty Zip-It®	222
T-Style Sign Holder With Pocket	177	Wall-Mount Sign Holder	172
Twin Wheel Casters	197	Warehouse Ceiling Hook For Solid Beam	264
Two-Level Brochure Holder	176	Warehouse Ceiling Hook For Split Beam	264
Two-Level Winged Back Brochure Holder	176	Warehouse Power Wing Clip – Metal	205
Two-Way Gripper Sign Holder	133	Warehouse Power Wing Clip – Plastic	205
Two-Way Merchandising Strip With Header	75	Warehouse Upright Adapter	175
Two-Way Sign Clip	145	Warehouse Upright Bracket	24, 112
Two-Way Winged Back Literature Holder	176	Warehouse Upright Bracket For Square Holes	24, 112
“U” Hook	234, 257	Warehouse Upright Gripper Sign Holder	107
Under-Shelf Bracket	22, 110	Warehouse Upright Gripper Sign Holder – Canadian	107
Under-Shelf Hardware-Mount Bracket	23, 110	Warehouse Upright Sign Holder For Square Holes	107
Under-Shelf Hardware-Mount Gripper Sign Holder	104	Weighted Base Flat Sign Holder	26, 165
Under-Shelf Hardware-Mount Merchandising Hanger	77	Weighted Base Sign Holder With Gripper	165
Under-Shelf Screw-Mount Gripper Sign Holder	103	Wide Base Gripper Sign Holder	115
Under-Shelf Spring-Mount Gripper Sign Holder	103	Wing Nut & Bolt Kit	223
Universal Adjustable Flush Grippers	147	Wire Basket Label Holder	43
Universal Crossbar	14, 54	Wire Basket Round Label Holder	43
Universal Info Strip Hinged Covered-Face Sign Holder	128	Wire Display Pole Foot	198
Universal Magnetic Adapter For Aisle Sign Arms	152	Wire Grid Sign Holder	136
Universal Pallet Floor Sign Holders	20, 88	Wire Mobile Hanger & Cord	252
Universal Three-Sided Mobile Kit	251	Wire Power Wing	18, 81
Upright Flip Inserts	221	Wire Snap Link	257, 271
Upward Shelf-Top Adhesive Sign Holder – Metal	146	Wobbler – Straight	135
Valance Clip	247	Wobbler – Tapered	135
“V” Clip	263	Wooden Banner Dowel End Cap	249
Vented Bin For Glass	19, 82	Wooden Banner Dowel Joiner	249
Versa Merchandising Strip	74	Wooden Banner Dowel Rods	249
Versa-Tab Coupon Holder	72	Wooden Banner Dowel Screw Eye	249
Versa-Tab With Butterfly Hole	72	X-Mas Tree Clip Fastener – Fin Type “P” – Reusable	213
Viking Clip Fastener – Push On Type	209	X-Mas Tree Clip Fastener – Fin Type “R” – Ratchet	214
Vinyl Graphic Banner Hanger Track	248	X-Mas Tree Clip Fastener – Fin Type “X” – Standard	215
Vinyl Pouch Tag Pocket With Adhesive	171	X-Mas Tree Clip Fasteners	213
Vinyl Pouch With Adhesive	171	“Y” Drop Style Cable Assemblies	270
Vinyl Pouch With Hanging Hole	170	Z-Bar Slatwall Adapter	207

ITEM #	DESCRIPTION	PAGE #	ITEM #	DESCRIPTION	PAGE #
100030	Aluminum Binder Post Extension 8-32, 1/4" L.	226	100063B	Black Aluminum Binder Post 8-32, Closed End, 1-3/4" L.	227
100031	Aluminum Binder Post Extension 8-32, 1/2" L.	226	100064	Aluminum Binder Post 8-32, Closed End, 2" L.	226
100032	Aluminum Binder Post Extension 8-32, 3/4" L.	226	100064B	Black Aluminum Binder Post 8-32, Closed End, 2" L.	227
100033	Aluminum Binder Post Extension 8-32, 1" L.	226	100065	Aluminum Binder Post 8-32, Closed End, 2-1/4" L.	226
100043	Gray Plastic Push-In Binder Screw 8/32, 3/8" L.	226	100066	Aluminum Binder Post 8-32, Closed End, 2-1/2" L.	226
100045	Aluminum Binder Post 8-32, Closed End, 1/4" L.	226	100067	Aluminum Binder Post 8-32, Closed End, 2-3/4" L.	226
100047	Aluminum Binder Post 8-32, Closed End, 3/8" L.	226	100068	Aluminum Binder Post 8-32, Closed End, 3" L.	226
100048	Aluminum Binder Post 8-32, Open End, 1/8" L.	226	100069	Aluminum Binder Post 8-32, Closed End, 3-1/4" L.	226
100048B	Black Aluminum Binder Post 8-32, Open End, 1/8" L.	227	100070	Aluminum Binder Post 8-32, Closed End, 3-1/2" L.	226
100049	Nickel Plated Steel PermaLock Binder Screw, 3/8" L.	226, 228	100072	Aluminum Binder Post 8-32, Closed End, 4" L.	226
100050	Aluminum Binder Screw 8-32, 3/16" L.	226	100073	Aluminum Binder Post 8-32, Closed End, 4-1/2" L.	226
100050B	Black Aluminum Binder Screw 8-32, 3/16" L.	227	100074	Aluminum Binder Post 8-32, Closed End, 5" L.	226
100051	Aluminum Binder Screw 8-32, 1/4" L.	226	100076	Aluminum Binder Post 8-32, Closed End, 6" L.	226
100051B	Black Aluminum Binder Screw 8-32, 1/4" L.	227	100147	Steel Binder Post 8-32, Closed End, 3/8" L.	228
100052	Aluminum Binder Screw 8-32, 3/8" L.	226	100151	Steel Binder Screw 8-32, 1/4" L.	228
100052B	Black Aluminum Binder Screw 8-32, 3/8" L.	227	100152	Steel Binder Screw 8-32, 3/8" L.	228
100053	Aluminum Binder Post 8-32, Open End, 3/16" L.	226	100153	Steel Binder Post 8-32, Open End, 3/16" L.	228
100053B	Black Aluminum Binder Post 8-32, Open End, 3/16" L.	227	100154	Steel Binder Post 8-32, Open End, 1/4" L.	228
100054	Aluminum Binder Post 8-32, Open End, 1/4" L.	226	100156	Steel Binder Post 8-32, Closed End, 1/2" L.	228
100054B	Black Aluminum Binder Post 8-32, Open End, 1/4" L.	227	100157	Steel Binder Post 8-32, Closed End, 5/8" L.	228
100055	Aluminum Binder Post 8-32, Open End, 3/8" L.	226	100158	Steel Binder Post 8-32, Closed End, 3/4" L.	228
100055B	Black Aluminum Binder Post 8-32, Open End, 3/8" L.	227	100160	Steel Binder Post 8-32, Closed End, 1" L.	228
100056	Aluminum Binder Post 8-32, Closed End, 1/2" L.	226	100161	Steel Binder Post 8-32, Closed End, 1-1/4" L.	228
100056B	Black Aluminum Binder Post 8-32, Closed End, 1/2" L.	227	100162	Steel Binder Post 8-32, Closed End, 1-1/2" L.	228
100057	Aluminum Binder Post 8-32, Closed End, 5/8" L.	226	100163	Steel Binder Post 8-32, Closed End, 1-3/4" L.	228
100057B	Black Aluminum Binder Post 8-32, Closed End, 5/8" L.	227	100164	Steel Binder Post 8-32, Closed End, 2" L.	228
100058	Aluminum Binder Post 8-32, Closed End, 3/4" L.	226	100231	Steel Barrel Bolt Extension 10-24	229
100058B	Black Aluminum Binder Post 8-32, Closed End, 3/4" L.	227	100242	Steel Barrel Screw 10-24, 5/16" L.	229
100059	Aluminum Binder Post 8-32, Closed End, 7/8" L.	226	100254	Steel Barrel Bolt 10-24, Open End, 1/4" L.	229
100060	Aluminum Binder Post 8-32, Closed End, 1" L.	226	100255	Steel Barrel Bolt 10-24, Closed End, 3/8" L.	229
100060B	Black Aluminum Binder Post 8-32, Closed End, 1" L.	227	100256	Steel Barrel Bolt 10-24, Closed End, 1/2" L.	229
100061	Aluminum Binder Post 8-32, Closed End, 1-1/4" L.	226	100257	Steel Barrel Bolt 10-24, Closed End, 5/8" L.	229
100061B	Black Aluminum Binder Post 8-32, Closed End, 1-1/4" L.	227	100258	Steel Barrel Bolt 10-24, Closed End, 3/4" L.	229
100062	Aluminum Binder Post 8-32, Closed End, 1-1/2" L.	226	100260	Steel Barrel Bolt 10-24, Closed End, 1" L.	229
100062B	Black Aluminum Binder Post 8-32, Closed End, 1-1/2" L.	227	100261	Steel Barrel Bolt 10-24, Closed End, 1-1/4" L.	229
100063	Aluminum Binder Post 8-32, Closed End, 1-3/4" L.	226	100262	Steel Barrel Bolt 10-24, Closed End, 1-1/2" L.	229
			100264	Steel Barrel Bolt 10-24, Closed End, 2" L.	229
			100342	Brass Binder Screw 8-32, 5/16" L.	227
			100347	Brass Binder Post 8-32, Closed End, 3/8" L.	227

ITEM #	DESCRIPTION	PAGE #	ITEM #	DESCRIPTION	PAGE #
100348	Brass Binder Post 8-32, Open End, 1/8" L.	227	100556	Rapid Assembly Plastic Binder Post 10-24, 1/2" L., White	230
100350	Brass Binder Screw 8-32, 3/16" L.	227	100556B	Rapid Assembly Plastic Binder Post 10-24, 1/2" L., Black	230
100351	Brass Binder Screw 8-32, 1/4" L.	227	100558	Rapid Assembly Plastic Binder Post 10-24, 3/4" L., White	230
100353	Brass Binder Post 8-32, Open End, 3/16" L.	227	100558B	Rapid Assembly Plastic Binder Post 10-24, 3/4" L., Black	230
100354	Brass Binder Post 8-32, Open End, 1/4" L.	227	100642	Stainless Steel Barrel Screw 10-24, 5/16" L.	229
100356	Brass Binder Post 8-32, Closed End, 1/2" L.	227	100654	Stainless Steel Barrel Bolt 10-24, Open End, 1/4" L.	229
100357	Brass Binder Post 8-32, Closed End, 5/8" L.	227	100655	Stainless Steel Barrel Bolt 10-24, Closed End, 3/8" L.	229
100358	Brass Binder Post 8-32, Closed End, 3/4" L.	227	100656	Stainless Steel Barrel Bolt 10-24, Closed End, 1/2" L.	229
100360	Brass Binder Post 8-32, Closed End, 1" L.	227	100657	Stainless Steel Barrel Bolt 10-24, Closed End, 5/8" L.	229
100361	Brass Binder Post 8-32, Closed End, 1-1/4" L.	227	100658	Stainless Steel Barrel Bolt 10-24, Closed End, 3/4" L.	229
100362	Brass Binder Post 8-32, Closed End, 1-1/2" L.	227	100660	Stainless Steel Barrel Bolt 10-24, Closed End, 1" L.	229
100363	Brass Binder Post 8-32, Closed End, 1-3/4" L.	227	100661	Stainless Steel Barrel Bolt 10-24, Closed End, 1-1/4" L.	229
100364	Brass Binder Post 8-32, Closed End, 2" L.	227	100662	Stainless Steel Barrel Bolt 10-24, Closed End, 1-1/2" L.	229
100447	Stainless Steel Binder Post 8-32, Closed End, 3/8" L.	228	100664	Stainless Steel Barrel Bolt 10-24, Closed End, 2" L.	229
100451	Stainless Steel Binder Screw 8-32, 1/4" L.	228	100742	Steel Barrel Screw 1/4-20, 5/16" L.	230
100452	Stainless Steel Binder Screw 8-32, 3/8" L.	228	100755	Steel Barrel Bolt 1/4-20, 3/8" L.	230
100453	Stainless Steel Binder Post 8-32, Open End, 3/16" L.	228	100756	Steel Barrel Bolt 1/4-20, 1/2" L.	230
100454	Stainless Steel Binder Post 8-32, Open End, 1/4" L.	228	100757	Steel Barrel Bolt 1/4-20, 5/8" L.	230
100456	Stainless Steel Binder Post 8-32, Closed End, 1/2" L.	228	100758	Steel Barrel Bolt 1/4-20, 3/4" L.	230
100457	Stainless Steel Binder Post 8-32, Closed End, 5/8" L.	228	100760	Steel Barrel Bolt 1/4-20, 1" L.	230
100458	Stainless Steel Binder Post 8-32, Closed End, 3/4" L.	228	100761	Steel Barrel Bolt 1/4-20, 1-1/4" L.	230
100460	Stainless Steel Binder Post 8-32, Closed End, 1" L.	228	100762	Steel Barrel Bolt 1/4-20, 1-1/2" L.	230
100461	Stainless Steel Binder Post 8-32, Closed End, 1-1/4" L.	228	100764	Steel Barrel Bolt 1/4-20, 2" L.	230
100462	Stainless Steel Binder Post 8-32, Closed End, 1-1/2" L.	228	101001	Pear Clip, Zinc Plated Steel	231
100463	Stainless Steel Binder Post 8-32, Closed End, 1-3/4" L.	228	101002	Hinged Snap Ring, 3/4" I.D., Nickel Finish	232
100464	Stainless Steel Binder Post 8-32, Closed End, 2" L.	228	101003	Hinged Snap Ring, 1" I.D., Nickel Finish	232
100545	Rapid Assembly Plastic Binder Post 10-24, 1/4" L., Slotted Drive, White	230	101004	Hinged Snap Ring, 1-1/2" I.D., Nickel Finish	232
100545B	Rapid Assembly Plastic Binder Post 10-24, 1/4" L., Black	230	101005	Hinged Snap Ring, 2" I.D., Nickel Finish	232
100547	Rapid Assembly Plastic Binder Post 10-24, 3/8" L., White	230	101006	Hinged Snap Ring, 2-1/2" I.D., Nickel Finish	232
100547B	Rapid Assembly Plastic Binder Post 10-24, 3/8" L., Black	230	101007	Hinged Snap Ring, 3" I.D., Nickel Finish	232
100550	Rapid Assembly Plastic Binder Screw 10-24, 1/4" L., No Drive, White	230	101008	Pear Clip, Brass Plated Steel	231
100551	Rapid Assembly Plastic Binder Screw 10-24, 1/4" L., Slotted Drive, White	230	101009	Pear Clip, Stainless Steel	231
100551B	Rapid Assembly Plastic Binder Screw 10-24, 1/4" L., Slotted Drive, Black	230	101010	Roller Style Pear Clip	231
100552	Rapid Assembly Plastic Binder Screw 10-24, 3/8" L., Slotted Drive, White	230	101011	Aluminum Roller Hook	231
100552B	Rapid Assembly Plastic Binder Screw 10-24, 3/8" L., Slotted Drive, Black	230	101015	Hinged Snap Ring, 1/2" I.D., Nickel Finish	232
100553	Rapid Assembly Plastic Binder Post 10-24, 1/4" L., No Drive, White	230	101016	Hinged Snap Ring, 1-1/4" I.D., Nickel Finish	232
			101017	Hinged Snap Ring, 3/4" I.D., Brass Finish	232
			101018	Hinged Snap Ring, 1" I.D., Brass Finish	232

ITEM #	DESCRIPTION	PAGE #	ITEM #	DESCRIPTION	PAGE #
101019	Hinged Snap Ring, 1-1/2" I.D., Brass Finish	232	102055	Beaded Chain Assembly, #6 Size, 24" L.	273
101025	Plastic Snap Ring, White	233	102056	Beaded Chain Assembly, #10 Size, 6" L.	273
101025B	Plastic Snap Ring, Black	233	102057	Beaded Chain Assembly, #10 Size, 12" L.	273
101025C	Plastic Snap Ring, Clear	233	102058	Beaded Chain Assembly, #10 Size, 24" L.	273
101026	Plastic Spiral Ring, White	233	103001	Steel Cable, 1/32" Dia., 100 ft., No Coating	266
101026C	Plastic Spiral Ring, Clear	233	103002	Steel Cable, 1/32" Dia., 250 ft., No Coating	266
101027	Plastic Overlap Ring, White	233	103003	Steel Cable, 1/32" Dia., 500 ft., No Coating	266
101027C	Plastic Overlap Ring, Clear	233	103004	Steel Cable, 1/32" Dia., 1,000 ft., No Coating	266
101028	Plastic Oval Snap Ring, White	234	103005	Steel Cable, 1/16" Dia., 100 ft., No Coating	266
101028C	Plastic Oval Snap Ring, Clear	234	103006	Steel Cable, 1/16" Dia., 250 ft., No Coating	266
101037	Ring Handle, 7" L.	232	103007	Steel Cable, 1/16" Dia., 500 ft., No Coating	266
101039	Ring Handle, 9" L.	232	103008	Steel Cable, 1/16" Dia., 1,000 ft., No Coating	266
101040	Ring Handle, 10" L.	232	103009	Steel Cable, 1/16" Dia., 100 ft., Vinyl Coating	266
101052	Screw Lock Ring, 2" I.D.	232	103010	Steel Cable, 1/16" Dia., 250 ft., Vinyl Coating	266
101053	Screw Lock Ring, 3" I.D.	232	103011	Steel Cable, 1/16" Dia., 500 ft., Vinyl Coating	266
101054	Screw Lock Ring, 4" I.D.	232	103012	Steel Cable, 1/16" Dia., 1,000 ft., Vinyl Coating	266
101055	Screw Lock Ring, 5" I.D.	232	103013	Steel Cable, 1/32" Dia., 10,000 ft., No Coating	266
101056	Screw Lock Ring, 6" I.D.	232	103014	Steel Cable, 1/16" Dia., 5,000 ft., No Coating	266
101057	Screw Lock Ring, 7" I.D.	232	103015	Steel Cable, 1/16" Dia., 5,000 ft., Vinyl Coating	266
101058	Screw Lock Ring, 8" I.D.	232	103017	Steel Cable, 1/8" Dia., 100 ft., No Coating	266
101060	Screw Lock Ring, 10" I.D.	232	103018	Steel Cable, 1/8" Dia., 250 ft., No Coating	266
101074	Wire Snap Link	257, 271	103019	Steel Cable, 1/8" Dia., 500 ft., No Coating	266
101075	Bit Snap Link	234	103022	Steel Cable, 1/8" Dia., 5,000 ft., No Coating	266
102001	Looped End Cable Assembly, 1/32" Dia., 6" L.	267	103023	Steel Cable, 1/32" Dia., 100 ft., Nylon Coating	266
102002	Looped End Cable Assembly, 1/32" Dia., 12" L.	267	103024	Steel Cable, 1/32" Dia., 250 ft., Nylon Coating	266
102003	Looped End Cable Assembly, 1/32" Dia., 18" L.	267	103025	Steel Cable, 1/32" Dia., 500 ft., Nylon Coating	266
102004	Looped End Cable Assembly, 1/32" Dia., 24" L.	267	103026	Steel Cable, 1/32" Dia., 1,000 ft., Nylon Coating	266
102005	Looped End Cable Assembly, 1/32" Dia., 36" L.	267	103029	Steel Cable, 1/32" Dia., 5,000 ft., Nylon Coating	266
102006	Looped End Cable Assembly, 1/16" Dia., 6" L.	267	103031	Steel Cable, 3/32" Dia., 100 ft., No Coating	266
102007	Looped End Cable Assembly, 1/16" Dia., 12" L.	267	103032	Steel Cable, 3/32" Dia., 250 ft., No Coating	266
102008	Looped End Cable Assembly, 1/16" Dia., 18" L.	267	103033	Steel Cable, 3/32" Dia., 500 ft., No Coating	266
102009	Looped End Cable Assembly, 1/16" Dia., 24" L.	267	103034	Steel Cable, 3/32" Dia., 1,000 ft., No Coating	266
102010	Looped End Cable Assembly, 1/16" Dia., 36" L.	267	103037	Steel Cable, 3/32" Dia., 5,000 ft., No Coating	266
102011	Looped End Cable Assembly, 1/16" Dia., 48" L.	267	104001	Metal Jack Chain, #16 Size, 250 ft., Bright Galvanized Steel	272
102012	Looped End Cable Assembly, 1/32" Dia., 48" L.	267	104001B	Metal Jack Chain, #16 Size, 250 ft., Black Oxide	272
102049	Beaded Chain Assembly, #3 Size, 4" L.	273	104002	Metal Jack Chain, #14 Size, 250 ft., Bright Galvanized Steel	272
102050	Beaded Chain Assembly, #3 Size, 6" L.	273	104003	Metal Jack Chain, #12 Size, 100 ft., Bright Galvanized Steel	272
102051	Beaded Chain Assembly, #3 Size, 12" L.	273	104010	Beaded Chain, #3 Size, 100 ft.	273
102052	Beaded Chain Assembly, #3 Size, 24" L.	273	104011	Beaded Chain, #3 Size, 250 ft.	273
102053	Beaded Chain Assembly, #6 Size, 6" L.	273	104012	Beaded Chain, #6 Size, 100 ft.	273
102054	Beaded Chain Assembly, #6 Size, 12" L.	273			

ITEM #	DESCRIPTION	PAGE #	ITEM #	DESCRIPTION	PAGE #
104013	Beaded Chain, #3 Size, 250 ft.	273	105052	Three Cavity Hand Swager	274
104014	Metal Jack Chain Kit, Bright Galvanized Steel	272	105053	Five Cavity Heavy Duty Swager	274
104014B	Metal Jack Chain Kit, Black Oxide	272	105060	Single End Economy Wrench, 1/4"	223
104015	Beaded Chain, #10 Size, 100 ft.	273	105061	Single End Economy Wrench, 5/16"	223
104016	Beaded Chain, #10 Size, 250 ft.	273	105062	Single End Economy Wrench, 3/8"	223
104020	Indoor/Outdoor Sign-Mounting Bracket Kit	201	105063	Single End Economy Wrench, 7/16"	223
104025	Beaded Chain Connector for #3 Size	273	105064	Single End Economy Wrench, 1/2"	223
104026	Beaded Chain Connector for #6 Size	273	105065	Combination Economy Wrench	223
104027	Beaded Chain Adjustable Coupling for #10 Size	273	105075	Economy Screwdriver, #2 Phillips Drive, 3" L.	223, 291
104029	Beaded Chain Adjustable Coupling for #3 Size	273	105076	Economy Screwdriver, #2 Phillips Drive, 4" L.	223, 291
104030	Beaded Chain Adjustable Coupling for #6 Size	273	105077	Economy Screwdriver, #2 Phillips Drive, 6" L.	223, 291
104041	Single Jack Chain Length, #16 Size, 12" L., Bright Galvanized Steel	272	105078	Economy Screwdriver, #3 Phillips Drive, 6" L.	223, 291
104042	Single Jack Chain Length, #16 Size, 24" L., Bright Galvanized Steel	272	105085	Economy Screwdriver, 1/4" Slotted Drive, 3" L.	223, 291
104043	Single Jack Chain Length, #16 Size, 36" L., Bright Galvanized Steel	272	105086	Economy Screwdriver, 1/4" Slotted Drive, 4" L.	223, 291
104043B	Single Jack Chain Length, #16 Size, 36" L., Black Oxide	272	105087	Economy Screwdriver, 1/4" Slotted Drive, 6" L.	223, 291
104044	Single Jack Chain Length, #16 Size, 48" L., Bright Galvanized Steel	272	105090	Fastener & Label Remover Tool	224
104044B	Single Jack Chain Length, #16 Size, 48" L., Black Oxide	272	105091	Economy Fastener & Label Remover Tool	224
104046	Single Jack Chain Length, #16 Size, 72" L., Bright Galvanized Steel	272	105092	Easy-Off Fastener & Label Remover Tool - Plastic	224
104100	Grid Ceiling Spanner Bar	262	105113	Fixed Style Cable End - Snap Hook	267
104200	Spiral Sign Board Pads, 8" H., Dollar Pad, White Sheet	92	105115	Bullet Style Cable Adjuster	268
104200B	Spiral Sign Board Pads, 8" H., Dollar Pad, Black Sheet	92	105125	Cable & Adjuster Kit, 5 ft.	271
104201	Spiral Sign Board Pads, 8" H., Cent Pad, White Sheet	92	105126	Cable & Adjuster Kit, 10 ft.	271
104201B	Spiral Sign Board Pads, 8" H., Cent Pad, Black Sheet	92	105127	Cable & Adjuster Kit, 15 ft.	271
104202	Spiral Sign Board Pads, 8" H., Reading Pad, White Sheet	92	105128	Cable & Adjuster Kit, 20 ft.	271
104203	Spiral Sign Board Pads, 11-1/8" H., Dollar Pad, White Sheet	92	105129	Cable & Adjuster Kit, 30 ft.	271
104204	Spiral Sign Board Pads, 11-1/8" H., Cent Pad, White Sheet	92	105130	Adjustable Trapeze Banner Hanger System, 30 ft. Cable Assembly	250, 287
104205	Spiral Sign Board Pads, 11-1/8" H., Reading Pad, White Sheet	92	105140	Bullet Style Cable & Adjuster Kit, 5 ft.	268
104206B	Spiral Sign Board Pads, 8" H., Beverage Pad, Black Sheet	92	105141	Bullet Style Cable & Adjuster Kit, 10 ft.	268
104215W	Spiral Sign Board Brackets	92	105142	Bullet Style Cable & Adjuster Kit, 20 ft.	268
105001	Cable Sleeve (Crimp), 1/32" Dia.	266	105143	Bullet Style Cable & Adjuster Kit, 30 ft.	268
105002	Cable Sleeve (Crimp), 1/16" Dia.	266	105155	Looping Cable Adjuster, for 1/32" & 1/16" Dia. Cable	270
105003	Cable Sleeve (Crimp), 1/8" Dia.	266	105156	Looping Cable Adjuster, for 3/32" & 1/8" Dia. Cable	270
105006	Cable Sleeve (Crimp), 3/32" Dia.	266	105157	Threaded Side Exit Cable Adjuster, Female Thread	269
105010	Alcohol Swab	220	105158	Pigtail Hook Side Exit Cable Adjuster	269
105015	Wing Nut & Bolt Kit	223	105159	Snap Hook Bottom Exit Cable Adjuster	269
105050	Steel Cable (Wire Rope) Cutter	274	105160	Ceiling Twist Side Exit Cable Adjuster	262, 270
105051	Economy Hand Swager, for 1/16" Dia. Cable	26, 274	105161	Threaded Side Exit Cable Adjuster, Male Thread	269
			106001	Hanging Coil, 1-1/4" L.	263

ITEM #	DESCRIPTION	PAGE #	ITEM #	DESCRIPTION	PAGE #
106002	"U" Hook	234, 257	106233	Warehouse Upright Sign Holder For Square Holes, No Hinge, up to .100" Grip	107
106005	Hanging Coil, 1" L.	263	106234	Warehouse Upright Sign Holder For Square Holes, No Hinge, .100" to .250" Grip	107
106020	Boot System Adhesive Base, White	98	106301	Gondola Upright Gripper Sign Holder, With Hinge, up to .100" Grip	106
106020B	Boot System Adhesive Base, Black	98	106302	Gondola Upright Gripper Sign Holder, With Hinge, .100" to .250" Grip	106
106021	Boot System Gondola Top Gripper Base, White	99	106303	Gondola Upright Gripper Sign Holder, No Hinge, up to .100" Grip	106
106021B	Boot System Gondola Top Gripper Base, Black	99	106304	Gondola Upright Gripper Sign Holder, No Hinge, .100" to .250" Grip	106
106022	Boot System Contoured Adhesive Base, White	98	106306	Gondola Upright "Offset" Gripper Sign Holder, With Hinge, up to .100"	20, 106
106022B	Boot System Contoured Adhesive Base, Black	98	106307	K-Frame Gondola Upright Holder, With Hinge	182
106025	Boot System Magnetic Base, White	98	106308	K-Frame Gondola Upright Holder, No Hinge	182
106025B	Boot System Magnetic Base, Black	98	106309	Gondola Upright "Offset" Gripper Sign Holder, With Hinge, .100 to .250"	20, 106
106095	K-Frame Hanger Clip	186	106310	Gripper Gondola Upright Header, Left End, 4" L.	97
106098	K-Frame Wire Flush Hanger Clip	186	106311	Gripper Gondola Upright Header, Right End, 4" L.	97
106117	K-Frame Holder With Adhesive, With Hinge	183	106312	Gripper Gondola Upright Header, Center, 4" L.	97
106118	K-Frame Holder With Adhesive, No Hinge	183	106313	Gripper Gondola Upright Header, Left End, 8" L.	97
106119	K-Frame Flush Holder With Adhesive	183	106314	Gripper Gondola Upright Header, Right End, 8" L.	97
106140	K-Frame Wall Mount Holder Kit	182	106315	Gripper Gondola Upright Header, Center, 8" L.	97
106201	Warehouse Upright Gripper Sign Holder, With Hinge, up to .100" Grip	107	106316	Gripper Gondola Upright Header, Left End, 12" L.	97
106202	Warehouse Upright Gripper Sign Holder, With Hinge, .100" to .250" Grip	107	106317	Gripper Gondola Upright Header, Right End, 12" L.	97
106203	Warehouse Upright Gripper Sign Holder, No Hinge, up to .100" Grip	107	106318	Gripper Gondola Upright Header, Center, 12" L.	97
106204	Warehouse Upright Gripper Sign Holder, No Hinge, .100" to .250" Grip	107	106319	Gripper Gondola Upright Header, Left End, 16" L.	97
106207	K-Frame Warehouse Upright Holder, With Hinge	183	106320	Gripper Gondola Upright Header, Right End, 16" L.	97
106208	K-Frame Warehouse Upright Holder, No Hinge	183	106321	Gripper Gondola Upright Header, Center, 16" L.	97
106210	Gripper Warehouse Upright Header, Left End, 4" L.	97	106401	Shelf-Top Gripper Sign Holder, With Hinge, up to .100" Grip, Beige	100
106211	Gripper Warehouse Upright Header, Right End, 4" L.	97	106401B	Shelf-Top Gripper Sign Holder, With Hinge, up to .100" Grip, Black	100
106212	Gripper Warehouse Upright Header, Center, 4" L.	97	106402	Shelf-Top Gripper Sign Holder, With Hinge, .100" to .250" Grip, Beige	100
106213	Gripper Warehouse Upright Header, Left End, 8" L.	97	106402B	Shelf-Top Gripper Sign Holder, With Hinge, .100" to .250" Grip, Black	100
106214	Gripper Warehouse Upright Header, Right End, 8" L.	97	106403	Shelf-Top Gripper Sign Holder, No Hinge, up to .100" Grip, Beige	100
106215	Gripper Warehouse Upright Header, Center, 8" L.	97	106403B	Shelf-Top Gripper Sign Holder, No Hinge, up to .100" Grip, Black	100
106216	Gripper Warehouse Upright Header, Left End, 12" L.	97	106404	Shelf-Top Gripper Sign Holder, No Hinge, .100" to .250" Grip, Beige	100
106217	Gripper Warehouse Upright Header, Right End, 12" L.	97	106404B	Shelf-Top Gripper Sign Holder, No Hinge, .100" to .250" Grip, Black	100
106218	Gripper Warehouse Upright Header, Center, 12" L.	97	106407	K-Frame Plastic Shelf-Top Holder, With Hinge	183
106219	Gripper Warehouse Upright Header, Left End, 16" L.	97	106408	K-Frame Plastic Shelf-Top Holder, No Hinge	183
106220	Gripper Warehouse Upright Header, Right End, 16" L.	97	106450	Upward Shelf-Top Adhesive Sign Holder - Metal	146
106221	Gripper Warehouse Upright Header, Center, 16" L.	97	106461	Slatwall Gripper Sign Holder, With Hinge, up to .100" Grip	106
106230	Perpendicular Gripper Sign Holder	25, 147			
106231	Warehouse Upright Sign Holder For Square Holes, With Hinge, up to .100" Grip	107			
106232	Warehouse Upright Sign Holder For Square Holes, With Hinge, .100" to .250" Grip	107			

ITEM #	DESCRIPTION	PAGE #	ITEM #	DESCRIPTION	PAGE #
106462	Slatwall Gripper Sign Holder, With Hinge, .100" to .250" Grip	106	106802	Shelf-Top Gripper Sign Holder - Metal, With Hinge, .100" to .250" Grip	100
106463	Slatwall Gripper Sign Holder, No Hinge, up to .100" Grip	106	106803	Shelf-Top Gripper Sign Holder - Metal, No Hinge, up to .100" Grip	100
106464	Slatwall Gripper Sign Holder, No Hinge, .100" to .250" Grip	106	106804	Shelf-Top Gripper Sign Holder - Metal, No Hinge, .100" to .250" Grip	100
106501	Pegboard Gripper Sign Holder, With Hinge, up to .100" Grip	106	106807	K-Frame Metal Shelf-Top Holder, With Hinge	183
106502	Pegboard Gripper Sign Holder, With Hinge, .100" to .250" Grip	106	106808	K-Frame Metal Shelf-Top Holder, No Hinge	183
106503	Pegboard Gripper Sign Holder, No Hinge, up to .100" Grip	106	106881	Warehouse Upright Gripper Sign Holder - Canadian, With Hinge, up to .100" Grip	107
106504	Pegboard Gripper Sign Holder, No Hinge, .100" to .250" Grip	106	106882	Warehouse Upright Gripper Sign Holder - Canadian, With Hinge, .100" to .250" Grip	107
106507	K-Frame Pegboard Holder, With Hinge	182	106883	Warehouse Upright Gripper Sign Holder - Canadian, No Hinge, up to .100" Grip	107
106508	K-Frame Pegboard Holder, No Hinge	182	106884	Warehouse Upright Gripper Sign Holder - Canadian, No Hinge, .100" to .250" Grip	107
106601	Channel Mount Gripper Sign Holder, With Hinge, up to .100" Grip	101	106890	Magnetic Adjustable Double-Hook Aisle Sign Arm	151
106602	Channel Mount Gripper Sign Holder, With Hinge, .100" to .250" Grip	101	106901	Telescopic Gripper Aisle Sign Holder - Gondola, With Hinge, up to .100" Grip, Beige	104
106603	Channel Mount Gripper Sign Holder, No Hinge, up to .100" Grip	101	106901B	Telescopic Gripper Aisle Sign Holder - Gondola, With Hinge, up to .100" Grip, Black	104
106604	Channel Mount Gripper Sign Holder, No Hinge, .100" to .250" Grip	101	106902	Telescopic Gripper Aisle Sign Holder - Gondola, With Hinge, .100" to .250" Grip, Beige	104
106607	K-Frame Plastic Channel Mount Holder, With Hinge	183	106902B	Telescopic Gripper Aisle Sign Holder - Gondola, With Hinge, .100" to .250" Grip, Black	104
106608	K-Frame Plastic Channel Mount Holder, No Hinge	183	106903	Telescopic Gripper Aisle Sign Holder - Gondola, No Hinge, up to .100" Grip, Beige	104
106621	Channel Mount Gripper Sign Holder - Metal, Thumb Screw, With Hinge, up to .100" Grip	101	106903B	Telescopic Gripper Aisle Sign Holder - Gondola, No Hinge, up to .100" Grip, Black	104
106622	Channel Mount Gripper Sign Holder - Metal, Thumb Screw, With Hinge, .100" to .250" Grip	101	106904	Telescopic Gripper Aisle Sign Holder - Gondola, No Hinge, .100" to .250" Grip, Beige	104
106623	Channel Mount Gripper Sign Holder - Metal, Thumb Screw, No Hinge, up to .100" Grip	101	106904B	Telescopic Gripper Aisle Sign Holder - Gondola, No Hinge, .100" to .250" Grip, Black	104
106624	Channel Mount Gripper Sign Holder - Metal, Thumb Screw, No Hinge, .100" to .250" Grip	101	106905	Telescopic Double-Hook Aisle Sign Holder - Gondola	105
106627	K-Frame Metal Channel Mount Holder, With Hinge	183	106906	Telescopic Double-Hook Aisle Sign Holder - Pegboard/Slatwall	105
106628	K-Frame Metal Channel Mount Holder, No Hinge	183	106907	K-Frame Telescopic Gondola Aisle Holder, With Hinge	182
106701	Under-Shelf Spring-Mount Gripper Sign Holder, With Hinge, up to .100" Grip	103	106908	K-Frame Telescopic Gondola Aisle Holder, No Hinge	182
106702	Under-Shelf Spring-Mount Gripper Sign Holder, With Hinge, .100" to .250" Grip	103	106911	Under-Shelf Screw-Mount Gripper Sign Holder, With Hinge, up to .100" Grip	103
106703	Under-Shelf Spring-Mount Gripper Sign Holder, No Hinge, up to .100" Grip	103	106912	Under-Shelf Screw-Mount Gripper Sign Holder, With Hinge, .100" to .250" Grip	103
106704	Under-Shelf Spring-Mount Gripper Sign Holder, No Hinge, .100" to .250" Grip	103	106913	Under-Shelf Screw-Mount Gripper Sign Holder, No Hinge, up to .100" Grip	103
106707	K-Frame Under-Shelf Spring-Mount Holder, With Hinge	184	106914	Under-Shelf Screw-Mount Gripper Sign Holder, No Hinge, .100" to .250" Grip	103
106708	K-Frame Under-Shelf Spring-Mount Holder, No Hinge	184	106917	K-Frame Under-Shelf Screw-Mount Holder, With Hinge	184
106781	Magnetic Shelf-Top Gripper Sign Holder, With Hinge, up to .100" Grip	102	106918	K-Frame Under-Shelf Screw-Mount Holder, No Hinge	184
106782	Magnetic Shelf-Top Gripper Sign Holder, With Hinge, .100" to .250" Grip	102	106921	Telescopic Gripper Aisle Sign Holder - Pegboard, With Hinge, up to .100" Grip, Beige	105
106783	Magnetic Shelf-Top Gripper Sign Holder, No Hinge, up to .100" Grip	102	106921B	Telescopic Gripper Aisle Sign Holder - Pegboard, With Hinge, up to .100" Grip, Black	105
106784	Magnetic Shelf-Top Gripper Sign Holder, No Hinge, .100" to .250" Grip	102	106922	Telescopic Gripper Aisle Sign Holder - Pegboard, With Hinge, .100" to .250" Grip, Beige	105
106787	K-Frame Magnetic Shelf-Top Holder, With Hinge	185	106922B	Telescopic Gripper Aisle Sign Holder - Pegboard, With Hinge, .100" to .250" Grip, Black	105
106788	K-Frame Magnetic Shelf-Top Holder, No Hinge	185			
106801	Shelf-Top Gripper Sign Holder - Metal, With Hinge, up to .100" Grip	100			

ITEM #	DESCRIPTION	PAGE #	ITEM #	DESCRIPTION	PAGE #
106923	Telescopic Gripper Aisle Sign Holder - Pegboard, No Hinge, up to .100" Grip, Beige	105	106972B	Magnetic Under-Shelf Gripper Sign Holder - L-Style, With Hinge, .100" to .250" Grip, Black	102
106923B	Telescopic Gripper Aisle Sign Holder - Pegboard, No Hinge, up to .100" Grip, Black	105	106973	Magnetic Under-Shelf Gripper Sign Holder - L-Style, No Hinge, up to .100" Grip	102
106924	Telescopic Gripper Aisle Sign Holder - Pegboard, No Hinge, .100" to .250" Grip, Beige	105	106973B	Magnetic Under-Shelf Gripper Sign Holder - L-Style, No Hinge, up to .100" Grip, Black	102
106924B	Telescopic Gripper Aisle Sign Holder - Pegboard, No Hinge, .100" to .250" Grip, Black	105	106974	Magnetic Under-Shelf Gripper Sign Holder - L-Style, No Hinge, .100" to .250" Grip	102
106927	K-Frame Telescopic Pegboard Aisle Holder, With Hinge	182	106974B	Magnetic Under-Shelf Gripper Sign Holder - L-Style, No Hinge, .100" to .250" Grip, Black	102
106928	K-Frame Telescopic Pegboard Aisle Holder, No Hinge	182	106977	K-Frame Magnetic Under-Shelf L-Style Holder, With Hinge	184
106930	"C" Clamp Bracket	21, 109	106978	K-Frame Magnetic Under-Shelf L-Style Holder, No Hinge	184
106931	"C" Clamp Gripper Aisle Sign Holder - Pegboard, With Hinge, up to .100" Grip	100	106981	Magnetic Non-Tip Under-Shelf Gripper Sign Holder, With Hinge, up to .100" Grip, Beige	103
106932	"C" Clamp Gripper Aisle Sign Holder - Pegboard, With Hinge, .100" to .250" Grip	100	106981B	Magnetic Non-Tip Under-Shelf Gripper Sign Holder, With Hinge, up to .100" Grip, Black	103
106933	"C" Clamp Gripper Aisle Sign Holder - Pegboard, No Hinge, up to .100" Grip	100	106982	Magnetic Non-Tip Under-Shelf Gripper Sign Holder, With Hinge, .100" to .250" Grip, Beige	103
106934	"C" Clamp Gripper Aisle Sign Holder - Pegboard, No Hinge, .100" to .250" Grip	100	106982B	Magnetic Non-Tip Under-Shelf Gripper Sign Holder, With Hinge, .100" to .250" Grip, Black	103
106937	K-Frame "C" Clamp Aisle Holder, With Hinge	183	106983	Magnetic Non-Tip Under-Shelf Gripper Sign Holder, No Hinge, up to .100" Grip, Beige	103
106938	K-Frame "C" Clamp Aisle Holder, No Hinge	183	106983B	Magnetic Non-Tip Under-Shelf Gripper Sign Holder, No Hinge, up to .100" Grip, Black	103
106941	Under-Shelf Hardware-Mount Gripper Sign Holder, With Hinge, up to .100" Grip	104	106984	Magnetic Non-Tip Under-Shelf Gripper Sign Holder, No Hinge, .100" to .250" Grip, Beige	103
106942	Under-Shelf Hardware-Mount Gripper Sign Holder, With Hinge, .100" to .250" Grip	104	106984B	Magnetic Non-Tip Under-Shelf Gripper Sign Holder, No Hinge, .100" to .250" Grip, Black	103
106943	Under-Shelf Hardware-Mount Gripper Sign Holder, No Hinge, up to .100" Grip	104	106991	Tool-Free Telescopic Gripper Aisle Sign Holder - Gondola, With Hinge, up to .100" Grip	104
106944	Under-Shelf Hardware-Mount Gripper Sign Holder, No Hinge, .100" to .250" Grip	104	106992	Tool-Free Telescopic Gripper Aisle Sign Holder - Gondola, With Hinge, .100" to .250" Grip	104
106947	K-Frame Under-Shelf Hardware-Mount Holder, With Hinge	184	106993	Tool-Free Telescopic Gripper Aisle Sign Holder - Gondola, No Hinge, up to .100" Grip	104
106948	K-Frame Under-Shelf Hardware-Mount Holder, No Hinge	184	106994	Tool-Free Telescopic Gripper Aisle Sign Holder - Gondola, No Hinge, .100" to .250" Grip	104
106961	Magnetic Under-Shelf Gripper Sign Holder, With Hinge, up to .100" Grip, Beige	102	106997	K-Frame Tool-Free Telescopic Gondola Aisle Holder, With Hinge	182
106961B	Magnetic Under-Shelf Gripper Sign Holder, With Hinge, up to .100" Grip, Black	102	106998	K-Frame Tool-Free Telescopic Gondola Aisle Holder, No Hinge	182
106962	Magnetic Under-Shelf Gripper Sign Holder, With Hinge, .100" to .250" Grip, Beige	102	107001	"V" Clip	263
106962B	Magnetic Under-Shelf Gripper Sign Holder, With Hinge, .100" to .250" Grip, Black	102	107003	Squeeze Clip	263
106963	Magnetic Under-Shelf Gripper Sign Holder, No Hinge, up to .100" Grip, Beige	102	107004	Figure "8" Squeeze Clip	263
106963B	Magnetic Under-Shelf Gripper Sign Holder, No Hinge, up to .100" Grip, Black	102	107005	Magnetic Clamp With Adhesive, 3" L., White	96
106964	Magnetic Under-Shelf Gripper Sign Holder, No Hinge, .100" to .250" Grip, Beige	102	107005B	Magnetic Clamp With Adhesive, 3" L., Black	96
106964B	Magnetic Under-Shelf Gripper Sign Holder, No Hinge, .100" to .250" Grip, Black	102	107006	Magnetic Clamp With Adhesive, 6" L., White	96
106967	K-Frame Magnetic Under-Shelf Holder, With Hinge, Beige	184	107006B	Magnetic Clamp With Adhesive, 6" L., Black	96
106967B	K-Frame Magnetic Under-Shelf Holder, With Hinge, Black	184	107007	Magnetic Clamp With Adhesive, 48" L., White	96
106968	K-Frame Magnetic Under-Shelf Holder, No Hinge, Beige	184	107007B	Magnetic Clamp With Adhesive, 48" L., Black	96
106968B	K-Frame Magnetic Under-Shelf Holder, No Hinge, Black	184	107008	Warehouse Ceiling Hook For Split Beam	264
106971	Magnetic Under-Shelf Gripper Sign Holder - L-Style, With Hinge, up to .100" Grip	102	107009	Warehouse Ceiling Hook For Solid Beam	264
106971B	Magnetic Under-Shelf Gripper Sign Holder - L-Style, With Hinge, up to .100" Grip, Black	102	107010	Ceiling Twist Loop, Round Base, White	258
106972	Magnetic Under-Shelf Gripper Sign Holder - L-Style, With Hinge, .100" to .250" Grip	102	107014	Swivel Snail Disk With Adhesive	263
			107015	Ceiling Twist Loop, Rectangular Base, White	258
			107015C	Ceiling Twist Loop, Rectangular Base, Clear	258

ITEM #	DESCRIPTION	PAGE #	ITEM #	DESCRIPTION	PAGE #
107017	Ceiling Twist Hook, White	258	107048C	Ceiling Hook & Cord, 8 ft., Clear	253
107017C	Ceiling Twist Hook, Clear	258	107049	Extra Heavy Duty Magnetic Adapter	217
107018	Swivel Ceiling Grid Clip	258	107050	Heavy Duty Magnetic Adapter	217
107019	Plastic Grid Clip With Hole, Clear	259	107051	Round Neo Disk Magnet, 7/16" Dia.	218
107020	Plastic Grid Clip With Hole, White	259	107053	Branched Multi-Cord Ceiling Clip, Twist-On, 3 Branches	253
107021	Metal Ceiling Twist Loop	262	107054	Branched Multi-Cord Ceiling Clip, Twist-On, 4 Branches	253
107022	Metal Ceiling Twist Stud	262	107055	Round Magnetic Adapter, 1-13/32" O.D.	218
107023	Adhesive Ceiling Loop	260	107056	Metal Squeeze Clip & Cord, White	252
107024	Clip-On Ceiling Loop	260	107056B	Metal Squeeze Clip & Cord, Black	252
107025	Clear Hinged Ceiling Hook	259	107059	Rectangular Neo Magnet With Adhesive	217
107026	Aluminum Ceiling Hook, Left	259	107060	Triway Mobile Kit, Small	251
107027	Aluminum Ceiling Hook, Right	259	107061	Triway Mobile Kit, Large	251
107028	"J" Hook With Adhesive	260	107062	K-Frame Flush Suction Cup Holder	182
107029	Ceiling Swivel Loop Clip	260	107063	Branched Multi-Cord Ceiling Clip, Hook, 3 Branches	253
107030	Magnetic Hook, 1" Base O.D., White	80, 261	107064	Branched Multi-Cord Ceiling Clip, Hook, 4 Branches	253
107031	Magnetic Hook, 1-1/4" Base O.D., White	80, 261	107065	Quadway Mobile Kit	251
107032	Magnetic Hook, 2" Base O.D., Chrome	80, 261	107066	K-Frame Flag Suction Cup Holder	182
107033	Magnetic Adapter, 1" L.	216	107067	K-Frame Magnetic Holder, With Hinge	184
107034	Ceiling Twist Clip & Cord, 4 ft., White	253	107068	K-Frame Magnetic Holder, No Hinge	184
107034C	Ceiling Twist Clip & Cord, 4 ft., Clear	253	107069	K-Frame Flush Magnetic Holder	184
107035	Magnetic Ceiling Loop, 2" L.	261	107070	Magnetic Clamp With Adhesive - Heavy Duty, 3" L., White	96
107036	Ceiling Twist Clip & Cord, 6 ft., White	253	107070B	Magnetic Clamp With Adhesive - Heavy Duty, 3" L., Black	96
107036C	Ceiling Twist Clip & Cord, 6 ft., Clear	253	107071	Magnetic Clamp With Adhesive - Heavy Duty, 6" L., White	96
107037	Magnetic Adapter, 3" L.	216	107071B	Magnetic Clamp With Adhesive - Heavy Duty, 6" L., Black	96
107038	Ceiling Twist Clip & Cord, 8 ft., White	253	107072	Magnetic Clamp With Adhesive - Heavy Duty, 48" L., White	96
107038C	Ceiling Twist Clip & Cord, 8 ft., Clear	253	107072B	Magnetic Clamp With Adhesive - Heavy Duty, 48" L., Black	96
107039	Magnetic Ceiling Loop, 1" L.	261	107073	Flexible Magnetic "C" Channel	40
107040	Non-Scratch Magnetic Insert	216	107075	Twin Wheel Casters, Threaded, Non-Locking	197
107041	Flexible Magnets, Roll of 1,200 Pieces, 1/2" W. x 1" L. Each	218	107076	Twin Wheel Casters, Threaded, Locking	197
107042	Flexible Magnets, Roll of 600 Pieces, 1" W. x 2" L. Each	218	107077	Twin Wheel Casters, Non-Threaded, Non-Locking	197
107043	Flexible Magnets, 100 Ft. Roll, 1" W.	218	107078	Twin Wheel Casters, Non-Threaded, Locking	197
107044	Ceiling Hook & Cord, 4 ft., White	253	107079	Magnetic Gripper Flush Sign Holder - Light Duty	117
107044B	Ceiling Hook & Cord, 4 ft., Black	253	107080	Magnetic Adapter With Adhesive, 1" L.	216
107044C	Ceiling Hook & Cord, 4 ft., Clear	253	107083	Magnetic Adapter With Adhesive, 3" L.	216
107045	Heavy Duty Magnetic Hook	261	107084	Snap-Lock Ceiling Clip & Cord, 4 ft., White	252
107046	Ceiling Hook & Cord, 6 ft., White	253	107084C	Snap-Lock Ceiling Clip & Cord, 4 ft., Clear	252
107046B	Ceiling Hook & Cord, 6 ft., Black	253	107085	Contoured Magnetic Back Shelf Gripper	68
107046C	Ceiling Hook & Cord, 6 ft., Clear	253	107086	Snap-Lock Ceiling Clip & Cord, 6 ft., White	252
107047	Round Magnetic Adapter, 2" O.D.	218			
107048	Ceiling Hook & Cord, 8 ft., White	253			
107048B	Ceiling Hook & Cord, 8 ft., Black	253			

ITEM #	DESCRIPTION	PAGE #	ITEM #	DESCRIPTION	PAGE #
107086C	Snap-Lock Ceiling Clip & Cord, 6 ft., Clear	252	107125	Price Channel Sign Holder	130
107087	Magnetic Sign Stand Adapter	153	107127	Shelf Extender Clip, With 1/4" Hole	78
107088	Snap-Lock Ceiling Clip & Cord, 8 ft., White	252	107128	Shelf Extender Clip, With Adhesive	78
107088C	Snap-Lock Ceiling Clip & Cord, 8 ft., Clear	252	107129	Swivel Display Caster With Corner Bracket, Non-Locking	197
107089	Magnetic Gripper Sign Holder - Light Duty, No Hinge	116	107130	Spring Wobbler	134
107090	Magnetic Gripper Flush Sign Holder, 1" L.	117	107131	Channel Mount Spring Wobbler	134
107091	Magnetic Gripper Flush Sign Holder, 3" L.	117	107133	Swivel Display Caster With Corner Bracket, Locking	197
107092	Magnetic Gripper Sign Holder - Light Duty, With Hinge	116	107134	Floor Stand Corner Glide	196
107093	Magnetic Gripper Sign Holder, With Hinge, up to .100" Grip	116	107135	Easel Card Holder - Angled	167
107094	Magnetic Gripper Sign Holder, With Hinge, .100" to .250" Grip	116	107136	Table Top Card Holder	166
107095	Magnetic Gripper Sign Holder, No Hinge, up to .100" Grip	116	107137	Flexible Display Foot	196
107096	Magnetic Gripper Sign Holder, No Hinge, .100" to .250" Grip	116	107138	Plastic Master Display Caster	197
107097	Magnetic Gripper Flag Sign Holder	117	107139	Display Caster With Adhesive, 2" x 2" Square	197
107098	Magnetic Gripper Sign Holder - Extra Tall	116	107140	Shelf Support Clips, Small, Male, White	188
107099	Magnetic Gripper Offset Sign Holder	117	107140B	Shelf Support Clips, Small, Male, Black	188
107100	Power Wire Wing Clip - Long Style	204	107141	Shelf Support Clips, Small, Female, White	188
107101	Power Wire Wing Clip	204	107141B	Shelf Support Clips, Small, Female, Black	188
107102	Heavy Duty Power Wire Wing Clip	204	107142	Shelf Support Clips, Large, Male, White	188
107103	Clear Power Wire Wing Clip, 1" W.	204	107143	Shelf Support Clips, Large, Female, White	188
107104	Clear Power Wire Wing Clip, 1-1/2" W.	204	107144	Rigid Display Feet, Corner	196
107105	Pegboard/Slatwall Power Wing Clip	206	107145	Rigid Display Feet, Center	196
107106	Shoe Clip Sign Holder	145	107146	Merchandising Strip Hanger For Cooler Door	76
107107	Metal Power Wire Wing Clip	205	107147B	Adjustable Pallet Guard	196
107108	Power Panel Bar, 15-1/2" L.	203	107148	Clip-On Corrugated Shelf Supports, Vertical, Standard	188
107110	Instant Flag Slatwall/Pegboard Display Base	148	107149	Clip-On Corrugated Shelf Supports, Horizontal, Heavy Duty	188
107111	Instant Flag Angled Display Base, No Adhesive	149	107151	Adhesive Strap Clip	201
107112	Instant Flag Angled Display Base, With Adhesive	149	107152	Pole Gripper, Small	200
107113	Slatwall Power Wing Clip	206	107153	Pole Gripper, Medium	200
107114	Metal Power Wire Wing Clip - Large Style	205	107154	Metal Mini Shelf Channel Adapter With Screw	125
107115	Warehouse Power Wing Clip - Metal	205	107156	Corrugated Shelf Support Inserts, 1/4" Single, No Adhesive	189
107116	Warehouse Power Wing Clip - Plastic	205	107157	Corrugated Shelf Support Inserts, 3/8" Double, No Adhesive	189
107117	Under-Shelf Hardware-Mount Merchandising Hanger	77	107158	Corrugated Shelf Support Inserts, 1/4" Single, With Adhesive	189
107118	Metal Adjustable Shelf Extender	71	107159	Heavy Duty Corrugated Shelf Support Inserts, 1/4" Single Capacity, No Adhesive	189
107119	Power Panel Bar, 19-1/4" L.	203	107160	Heavy Duty Corrugated Shelf Support Inserts, 3/8" Double Capacity, No Adhesive	189
107120	Pallet Display Clip	191	107161	Heavy Duty Corrugated Shelf Support Inserts, 1/4" Single Capacity, With Adhesive	189
107121	Double Merchandising Strip Hanger, Zinc Plated	77	107163	One-Piece Folding Aluminum Ceiling Hook	259
107122	Double Merchandising Strip Hanger, Painted Beige	77	107164	Chip Strip For Price Channel, Rectangular, 1-3/16" H. x 2" L.	31
107123	Channel Mount With Adhesive, 1" L.	124	107168	Chip Strip For Price Channel, Rectangular, 1-1/4" H. x 3" L.	31
107124	Channel Mount With Adhesive, 2" L.	124			

ITEM #	DESCRIPTION	PAGE #
107170	Chip Strip For Price Channel, Rectangular, 1-1/4" H. x 2-1/2" L.	31
107171	Chip Strip For Price Channel, "T" Shape With Tab, 1-1/4" H. x 2-1/2" L.	31
107176	Chip Strip For Price Channel, 1-1/4" x 1-1/2"	31
107180	Metal Shelf Channel Adapter With Screw	125
107181	Shelf Channel Adapter With Screw	125
107182	Side Insert Label Holder For Scan Hook	48
107198	Multi-Purpose Formed Style Label Holder	42
107200	Self-Piercing Flag Sign Holder	129
107201	Self-Piercing Channel Flag Holder, Standard	129
107202	Self-Piercing Channel Flush Holder	123
107203	Self-Piercing Flush Sign Holder	121
107204	Label Holder For Wire Fixtures, 2" W., Natural	42
107205	Label Holder For Wire Fixtures, 3" W., Natural	42
107205W	Label Holder For Wire Fixtures, 3" W., White	42
107206	Label Holder For Wire Fixtures, 3-1/2" W., Natural	42
107206W	Label Holder For Wire Fixtures, 3-1/2" W., White	42
107207	Ticket Holder For Wire Fixtures, 3" W.	42
107208	Self-Piercing Wire Flush Sign Holder	136
107209	Self-Piercing Channel Flag Holder, Angled	129
107211	Heavy Duty Self-Piercing Channel Flag Holder	129
107212	Ticket Holder For Wire Fixtures, 2" W.	42
107213	Label Holder For Double Wire Shelf	43
107214	Ticket Holder For Wire Fixtures, 4-1/2" W.	42
107215	Wire Basket Label Holder, 2" W.	43
107216	Wire Basket Label Holder, 2-1/8" W.	43
107217	Wire Basket Label Holder, 3-3/8" W.	43
107225	Shelf-Top Flag Sign Holder	128
107227	Round Neo Disk Magnet, 1" Dia.	218
107232	Tapered Display Hooks With Scan Plate, 2" L.	55
107233	Tapered Display Hooks With Scan Plate, 3" L.	55
107234	Tapered Display Hooks With Scan Plate, 4" L.	55
107236	Tapered Display Hooks With Scan Plate, 6" L.	55
107242	Tapered Display Hooks With T-Scan Bar, 2" L.	56
107244	Tapered Display Hooks With T-Scan Bar, 4" L.	56
107246	Tapered Display Hooks With T-Scan Bar, 6" L.	56
107250	K-Ads Billboard Suction Cup Sign Holder, Aluminum, 14" L.	113
107251	K-Ads Billboard Suction Cup Sign Holder, Plastic, 14" L.	113
107253	K-Ads Billboard Suction Cup Sign Holder, Aluminum, 7" L.	113
107254	K-Ads Billboard Suction Cup Sign Holder, Plastic, 7" L.	113

ITEM #	DESCRIPTION	PAGE #
107262	Corrugated/Wire Combo Display Hooks With Scan Plate, 2" L.	58
107263	Corrugated/Wire Combo Display Hooks With Scan Plate, 3" L.	58
107264	Corrugated/Wire Combo Display Hooks With Scan Plate, 4" L.	58
107266	Corrugated/Wire Combo Display Hooks With Scan Plate, 6" L.	58
107268	Corrugated/Wire Combo Display Hooks With Scan Plate, 8" L.	58
107282	Pegboard/Slatwall Display Hooks With T-Scan Bar, 2" L.	60
107284	Pegboard/Slatwall Display Hooks With T-Scan Bar, 4" L.	60
107286	Pegboard/Slatwall Display Hooks With T-Scan Bar, 6" L.	60
107293	Corrugated Universal Butterfly Display Hooks, 3" L.	56
107294	Corrugated Universal Butterfly Display Hooks, 4" L.	56
107295	Corrugated Universal Butterfly Display Hooks, 5" L.	56
107296	Corrugated Universal Butterfly Display Hooks, 6" L.	56
107298	Corrugated Universal Butterfly Display Hooks, 8" L.	56
107301	Corrugated Tapered Back Display Hooks, 1" L., White	55
107301B	Corrugated Tapered Back Display Hooks, 1" L., Black	55
107302	Corrugated Tapered Back Display Hooks, 2" L., White	55
107302B	Corrugated Tapered Back Display Hooks, 2" L., Black	55
107303	Corrugated Tapered Back Display Hooks, 3" L., White	55
107303B	Corrugated Tapered Back Display Hooks, 3" L., Black	55
107304	Corrugated Tapered Back Display Hooks, 4" L., White	55
107304B	Corrugated Tapered Back Display Hooks, 4" L., Black	55
107305	Corrugated Tapered Back Display Hooks, 5" L., White	55
107305B	Corrugated Tapered Back Display Hooks, 5" L., Black	55
107306	Corrugated Tapered Back Display Hooks, 6" L., White	55
107306B	Corrugated Tapered Back Display Hooks, 6" L., Black	55
107307	Corrugated Tapered Back Display Hooks, 7" L., White	55
107307B	Corrugated Tapered Back Display Hooks, 7" L., Black	55
107308	Corrugated Tapered Back Display Hooks, 8" L., White	55
107308B	Corrugated Tapered Back Display Hooks, 8" L., Black	55
107312	Corrugated/Wire Combo Display Hooks, 2" L., White	59
107312B	Corrugated/Wire Combo Display Hooks, 2" L., Black	59
107313	Corrugated/Wire Combo Display Hooks, 3" L., White	59
107313B	Corrugated/Wire Combo Display Hooks, 3" L., Black	59

ITEM #	DESCRIPTION	PAGE #	ITEM #	DESCRIPTION	PAGE #
107314	Corrugated/Wire Combo Display Hooks, 4" L., White	59	107394	Corrugated Universal Display Hooks With Scan Plates, 4" L.	57
107314B	Corrugated/Wire Combo Display Hooks, 4" L., Black	59	107396	Corrugated Universal Display Hooks With Scan Plates, 6" L.	57
107315	Corrugated/Wire Combo Display Hooks, 5" L., White	59	107400	Self-Sticking Cardboard Easel, 5" H., Single-Wing, White	180
107315B	Corrugated/Wire Combo Display Hooks, 5" L., Black	59	107400B	Self-Sticking Cardboard Easel, 5" H., Single-Wing, Black	180
107316	Corrugated/Wire Combo Display Hooks, 6" L., White	59	107401	Self-Sticking Cardboard Easel, 7" H., Single-Wing, White	180
107316B	Corrugated/Wire Combo Display Hooks, 6" L., Black	59	107401B	Self-Sticking Cardboard Easel, 7" H., Single-Wing, Black	180
107321	Butterfly Display Hooks, 1" L., White	56	107402	Self-Sticking Cardboard Easel, 7" H., Double-Wing, White	180
107322	Butterfly Display Hooks, 2" L., White	56	107402B	Self-Sticking Cardboard Easel, 7" H., Double-Wing, Black	180
107322B	Butterfly Display Hooks, 2" L., Black	56	107403	Self-Sticking Cardboard Easel, 12" H., Double-Wing, White	180
107323	Butterfly Display Hooks, 3" L., White	56	107403B	Self-Sticking Cardboard Easel, 12" H., Double-Wing, Black	180
107323B	Butterfly Display Hooks, 3" L., Black	56	107405	Easel Back Sign Holder, 8-1/2" W. x 11" H., Portrait	179
107324	Butterfly Display Hooks, 4" L., White	56	107406	Easel Back Sign Holder, 11" W. x 14" H., Portrait	179
107324B	Butterfly Display Hooks, 4" L., Black	56	107407	Static Cling Print Protector	169
107325	Butterfly Display Hooks, 5" L., White	56	107408	Print Protectors, 4" x 6"	169
107325B	Butterfly Display Hooks, 5" L., Black	56	107409	Print Protectors, 8-1/2" x 11"	169
107326	Butterfly Display Hooks, 6" L., White	56	107410	Acrylic Wall-Mount Sign Holder, Landscape	172
107326B	Butterfly Display Hooks, 6" L., Black	56	107411	Acrylic Wall-Mount Sign Holder, Portrait	172
107327	Butterfly Display Hooks, 7" L., White	56	107412	Slim-Line Oversized Sign Protector, 8" W. x 5-1/2" H.	126
107327B	Butterfly Display Hooks, 7" L., Black	56	107413	Slim-Line Oversized Sign Protector, 8" W. x 11" H.	126
107334	Pegboard/Slatwall Display Hooks With "C" Channel, 4" L.	60	107414	Rigid Covered Sign Holder With Holes	172
107336	Pegboard/Slatwall Display Hooks With "C" Channel, 6" L.	60	107415	Counter Mat Sign Holder, for 8-1/2" x 11" Graphic	87
107342	Pegboard/Slatwall Display Hooks With Scan Plate, 2" L.	60	107416	Counter Mat Sign Holder, for 11" x 17" Graphic	87
107344	Pegboard/Slatwall Display Hooks With Scan Plate, 4" L.	60	107422	Corrugated Universal Display Hooks With T-Scan Bar, 2" L.	57
107346	Pegboard/Slatwall Display Hooks With Scan Plate, 6" L.	60	107424	Corrugated Universal Display Hooks With T-Scan Bar, 4" L.	57
107362	Butterfly Corrugated/Wire Combo Display Hooks, 2" L.	59	107426	Corrugated Universal Display Hooks With T-Scan Bar, 6" L.	57
107363	Butterfly Corrugated/Wire Combo Display Hooks, 3" L.	59	107432	Tapered Display Hooks With "C" Channel, 2" L.	55
107364	Butterfly Corrugated/Wire Combo Display Hooks, 4" L.	59	107434	Tapered Display Hooks With "C" Channel, 4" L.	55
107365	Butterfly Corrugated/Wire Combo Display Hooks, 5" L.	59	107436	Tapered Display Hooks With "C" Channel, 6" L.	55
107366	Butterfly Corrugated/Wire Combo Display Hooks, 6" L.	59	107444	Corrugated/Wire Combo Display Hooks With "C" Channel, 4" L.	58
107371	Corrugated Universal Display Hooks, 1-1/4" L.	58	107446	Corrugated/Wire Combo Display Hooks With "C" Channel, 6" L.	58
107372	Corrugated Universal Display Hooks, 2" L.	58	107462	Pegboard/Slatwall Display Hooks, 2" L., White	59
107374	Corrugated Universal Display Hooks, 4" L.	58	107462B	Pegboard/Slatwall Display Hooks, 2" L., Black	59
107376	Corrugated Universal Display Hooks, 6" L.	58	107463	Pegboard/Slatwall Display Hooks, 3" L., White	59
107378	Corrugated Universal Display Hooks, 8" L.	58	107463B	Pegboard/Slatwall Display Hooks, 3" L., Black	59
107384	Corrugated Universal Display Hooks With "C" Channel, 4" L.	57	107464	Pegboard/Slatwall Display Hooks, 4" L., White	59
107386	Corrugated Universal Display Hooks With "C" Channel, 6" L.	57	107464B	Pegboard/Slatwall Display Hooks, 4" L., Black	59
107392	Corrugated Universal Display Hooks With Scan Plates, 2" L.	57	107466	Pegboard/Slatwall Display Hooks, 6" L., White	59

ITEM #	DESCRIPTION	PAGE #	ITEM #	DESCRIPTION	PAGE #
107466B	Pegboard/Slatwall Display Hooks, 6" L., Black	59	107734	Speedy-Back Adapter For Straight Entry Metal Hook, Heavy-Duty	15, 52, 64
107468	Pegboard/Slatwall Display Hooks, 8" L., White	59	107737	Speedy-Back Adapter For Straight Entry Metal Hook, Medium-Duty	52
107468B	Pegboard/Slatwall Display Hooks, 8" L., Black	59	107995	Shelf-Top Merchandising Strip Hanger - Plastic	78
107500	Inventory Control Tube, 2" L.	62	107999	Double "S" Hook	79
107501	Inventory Control Tube, 3" L.	62	108000	Heavy Duty "S" Hook	79
107502	Display Hook Product Stop	61	108001	"C" Link, 1-1/2" L.	257
107503	Butterfly Hook Product Stop	61	108002	"C" Link, 3" L.	257
107504	Round Inventory Control Unit, White	62	108003	"S" Hook, .080" Dia., 1" L., Bright Galvanized Steel	79, 257, 271
107504B	Round Inventory Control Unit, Black	62	108003B	"S" Hook, .080" Dia., 1" L., Black Oxide	79, 257, 271
107504C	Round Inventory Control Unit, Clear	62	108004	"S" Hook, .093" Dia., 7/8" L., Bright Galvanized Steel	79, 257, 271
107505	Inventory Control Unit	62	108005	"S" Hook, .120" Dia., 1-5/16" L., Bright Galvanized Steel	79, 257, 271
107506W	Squeeze Style Inventory Control Unit, .162" to .207" Grip, White	62	108006	"S" Hook, .135" Dia., 1-5/8" L., Bright Galvanized Steel	79, 257, 271
107507B	Squeeze Style Inventory Control Unit, .200" to .280" Grip, Black	62	108007	"S" Hook, .148" Dia., 2" L., Bright Galvanized Steel	79, 257, 271
107508B	Peg Hook Product Stop	61	108008	"S" Hook, .177" Dia., 2-7/8" L., Bright Galvanized Steel	79, 257, 271
107600	Display Poles, Male, Small, White	198	108009	Perf Shelf "S" Hook, Standard	79
107601	Display Poles, Male, Medium, White	198	108010	Double "C" Hook, 4" L.	256
107601B	Display Poles, Male, Medium, Black	198	108011	Double "C" Hook, 6" L.	256
107602	Display Poles, Male, Large, White	198	108012	Double "C" Hook, 8" L.	256
107602B	Display Poles, Male, Large, Black	198	108013	Double "C" Hook, 10" L.	256
107603	Display Poles, Female, Small	198	108014	Double "C" Hook, 12" L.	256
107604	Display Poles, Female, Medium, White	198	108015	Double "C" Hook, 16" L.	256
107604B	Display Poles, Female, Medium, Black	198	108016	Double "C" Hook, 18" L.	256
107605	Display Poles, Female, Large, White	198	108017	Double "C" Hook, 20" L.	256
107605B	Display Poles, Female, Large, Black	198	108018	Double "C" Hook, 24" L.	256
107606	Display Pole, Male, Extra Large, White	198	108020	Double "C" Hook, 30" L.	256
107606B	Display Pole, Male, Extra Large, Black	198	108021	Double "C" Hook, 36" L.	256
107607	Display Pole, Female, Extra Large, White	198	108022	Double "C" Hook, 40" L.	256
107607B	Display Pole, Female, Extra Large, Black	198	108023	Double "C" Hook, 48" L.	256
107700B	Universal Magnetic Adapter For Aisle Sign Arms	152	108029	Perf Shelf "S" Hook, Pinched	79
107701	Pegboard/Slatwall Adapter For Aisle Sign Arms, Heavy-Duty	53, 152	108030	Mobile Springs, 6" L.	255
107702	Metal Adapter For Crossbar & Wire Grids	152	108031	Mobile Springs, 8" L.	255
107703B	Double Magnetic Adapter Base For Aisle Sign Arms	153	108032	Mobile Springs, 12" L.	255
107704	Pegboard/Slatwall Adapter For Aisle Sign Arms, Medium-Duty	53	108033	Crystal Ticket Holder, 1-1/4" H. x 2-1/2" L.	44
107710B	Aisle Sign Arm Hanger - Straight	151	108035	Shelf-Top Hook For Flag Merchandising	77
107711B	Aisle Sign Arm Hanger - Curved	150	108036	Shelf-Top Hook For Flush Merchandising	77
107712B	Aisle Sign Arm Hanger - Shepherd	150	108040	Wire Mobile Hanger & Cord	252
107713B	Aisle Sign Arm Hanger - Arched	150	108041	Brass Wire Mobile Hanger & Cord, 4 ft. L.	252
107714W	Channel-Mount Arm Hanger - Curved	150	108042	Brass Wire Mobile Hanger & Cord, 6 ft. L.	252
107716B	Garment Display Hanger	151	108050	Wire Display Pole Foot, Small	198
107718B	Aisle Sign Arm Hanger - Adjustable Hook	151			

ITEM #	DESCRIPTION	PAGE #	ITEM #	DESCRIPTION	PAGE #
108051	Wire Display Pole Foot, Medium	198	108516	Gripper Flush Sign Holder, 1-1/2" L.	122
108052	Wire Display Pole Foot, Large	198	108517	Gripper Flush Sign Holder, 3" L.	122
108053	Wire Display Pole Foot, Extra Large	198	108518	Gripper "H" Sign Holder, 1" L.	138, 195
108055B	Molded Plastic Display Feet Kit	198	108519	Gripper "H" Sign Holder, 3" L.	138, 195
108060	Gripper Sign Holder For Display Poles	199	108520	Hinged Gripper Sign Holder, 3" L., up to .100" Grip	115
108070	Flute Wire, .072" Dia., 6" L.	190	108521	Gripper Wire Flag Sign Holder, .200" Wire Dia. Capacity	137
108071	Flute Wire, .072" Dia., 12" L.	190	108522	Gripper Wire Flush Sign Holder, 1/2" L.	137
108072	Flute Wire, .072" Dia., 24" L.	190	108523	Gripper Sign Holder, 1" L., 1/2" W., "Permanent" Adhesive	114
108073	Flute Wire, .080" Dia., 6" L.	190	108523R	Gripper Sign Holder, 1" L., 1/2" W., "Removable" Adhesive	114
108074	Flute Wire, .080" Dia., 12" L.	190	108524	Gripper Sign Holder Insert, Standard	114, 239, 242, 245
108075	Flute Wire, .080" Dia., 24" L.	190	108524R	Gripper Sign Holder, 3" L., 1/2" W., "Removable" Adhesive	114
108100	Price Channel Gripper Flag Sign Holder, Standard	130	108525	Gripper Sign Holder, 1" L., 1" W., "Permanent" Adhesive	114
108101	Info Strip Hinged Gripper Flag Sign Holder	131	108525R	Gripper Sign Holder, 1" L., 1" W., "Removable" Adhesive	114
108102	Info Strip Gripper Flag Sign Holder, Standard	131	108526	Gripper Sign Holder, 3" L., 1" W., "Permanent" Adhesive	114
108103	Info Strip Hinged Universal Flag Sign Holder	131	108526R	Gripper Sign Holder, 3" L., 1" W., "Removable" Adhesive	114
108104	Perf Shelf Gripper Flag Sign Holder	129	108527	Heavy Duty Gripper Sign Holder - Wide, 3" L.	114
108105	Notched Gripper Wire Flag Sign Holder	137	108527R	Heavy Duty Gripper Sign Holder - Wide, 3" L. with Removable Adhesive	114
108106	Gripper Dual Action Flag Sign Holder	130	108528	Heavy Duty Gripper Sign Holder - Wide, 6" L.	114
108107	Hinged Gripper Flag Sign Holder	133	108529	Gripper Wire Flush Sign Holder, 1" L.	137
108108	Hinged Gripper Flush Sign Holder	119	108530	Hinged Gripper Offset Sign Holder	146
108109	Hinged Gripper Square Shelf Flag Sign Holder	133	108531	Heavy Duty Gripper Sign Holder - Narrow, 1-1/2" L.	114
108110	Hinged Gripper Square Shelf Flush Sign Holder, for 1/2" thru 5/8" Shelves	119	108532	Gripper Sign Holder Insert, Heavy Duty	114, 239, 242, 245
108111	Info Strip Flag Sign Holder	132	108533	Heavy Duty Gripper Sign Holder - Narrow, 6" L.	114
108500	Slatwall Adapter With Adhesive, 1" L.	207	108535	Gripper Sign Holder, 6" L., 1" W., "Permanent" Adhesive	114
108501	Adhesive Wire/Pen Clip	140	108536	Rotatable Gripper Sign Holder	115
108503	Economy Info Strip Flush Sign Holder	121	108537	Gripper "U" Channel Panel Former, 1/8" to 3/16" Grip, Clear	192
108504	Slatwall Adapter With Adhesive, 4" L.	207	108537W	Gripper "U" Channel Panel Former, 1/8" to 3/16" Grip, White	192
108505	All Purpose Adhesive Clip, .300" I.D., 1.000" L.	139	108538	Gripper "U" Channel Panel Former, 3/16" to 1/4" Grip, Clear	192
108506	All Purpose Adhesive Clip, .180" I.D., .844" L.	139	108538W	Gripper "U" Channel Panel Former, 3/16" to 1/4" Grip, White	192
108507	Boot System Thin Poster Channel, 12" L.	99	108539	Hinged Gripper Sign Holder, 36" L., up to .100" Grip	115
108508	Boot System Thin Poster Channel, 18" L.	99	108542	Heavy Duty Gripper Flush Sign Holder, 1-1/2" L.	122
108509C	Pegboard/Slatwall Adapter, 2 Prongs, No Adhesive, Clear	207	108543	Heavy Duty Gripper Flush Sign Holder, 3" L.	122
108510	Pegboard/Slatwall Adapter, 2 Prongs, With Adhesive, White	207	108544	Hinged Gripper Flush Mount Sign Holder, 3" L., up to .100" Grip	118
108510C	Pegboard/Slatwall Adapter, 2 Prongs, With Adhesive, Clear	207	108546	Flip-Up Pallet Tag	32
108511	Pegboard/Slatwall Adapter, 4 Prongs, With Adhesive, Natural	207	108547	Heavy Duty Gripper Sign Holder - Extra Wide, 3" L.	114
108512	Z-Bar Slatwall Adapter	207	108548	Heavy Duty Gripper Sign Holder - Extra Wide, 6" L.	114
108513	Boot System Heavy Duty Gripper Poster Channel, 12" L.	99			
108514	Boot System Heavy Duty Gripper Poster Channel, 18" L.	99			
108515	Gripper Flush Sign Holder, 1" L.	122			

ITEM #	DESCRIPTION	PAGE #	ITEM #	DESCRIPTION	PAGE #
108549	Gripper Twist-In Sign Holder	128	108585W	Heavy Duty Self-Adhesive Info Strip	28
108551	Hinged Gripper Sign Holder, 3" L., .125" to .187" Grip	115	108586	Economy Card Holder, 6" L.	166
108552	Hinged Gripper Sign Holder, 36" L., .125" to .187" Grip	115	108587	Economy Card Holder, 3" L.	166
108553	Gripper T-Style Table Top Sign Holder, 3" L.	115	108590	Gripper Wire Grid Sign Holder	136
108554	Gripper T-Style Table Top Sign Holder, 6" L.	115	108591	Pole Gripper Sign Holder, for Small Poles	200
108555	Gondola Top Gripper Sign Holder, 3" L.	148	108592	Below Shelf Sign Holder, 3" H., 48" L.	33
108556	Gondola Top Gripper Sign Holder, 6" L.	148	108593	Gripper Flip-Up Flush Sign Holder	122
108557	Gripper 180 Degree "H" Panel Former, 1/8" to 3/16" Grip, Clear	192	108594	Universal Info Strip Hinged Covered-Face Sign Holder	128
108557W	Gripper 180 Degree "H" Panel Former, 1/8" to 3/16" Grip, White	192	108600	"J" Channel With Adhesive, up to .060" Grip, Clear, Foam Tape	94
108558	Gripper 180 Degree "H" Panel Former, 3/16" to 1/4" Grip, Clear	192	108600B	"J" Channel With Adhesive, up to .060" Grip, Black, Foam Tape	94
108558W	Gripper 180 Degree "H" Panel Former, 3/16" to 1/4" Grip, White	192	108600T	"J" Channel With Adhesive, up to .060" Grip, Black, Adhesive Transfer Tape	94
108559	Flip-Up Covered Face Sign Holder, 2" H.	32	108600W	"J" Channel With Adhesive, up to .060" Grip, White, Foam Tape	94
108561	Flip-Up Covered Face Sign Holder, 3" H.	32	108601	"J" Channel With Adhesive, up to .125" Grip, Clear, Foam Tape	94
108562	"J" Hook Wire Sign Holder	139	108601B	"J" Channel With Adhesive, up to .125" Grip, Black, Foam Tape	94
108563	Gripper Square Edge Sign Holder, .625" to .750" Base Capacity	148	108601W	"J" Channel With Adhesive, up to .125" Grip, White, Foam Tape	94
108564	Gripper Square Edge Sign Holder, .875" to 1.000" Base Capacity	148	108602	"H" Channel With Adhesive, Clear	94
108566	Tip-On Flush Sign Holder, 1" L., Foam Tape	95	108602B	"H" Channel With Adhesive, Black	94
108567	Tip-On Flush Sign Holder, 3" L., Foam Tape	95	108602W	"H" Channel With Adhesive, White	94
108568	Tip-On Flush Sign Holder, 6" L., Foam Tape	95	108603	Gripper 90 Degree Panel Former, 1/8" to 3/16" Grip, Clear	192
108569	Tip-On Flush Sign Holder, 48" L., Foam Tape	95	108603W	Gripper 90 Degree Panel Former, 1/8" to 3/16" Grip, White	192
108569T	Tip-On Flush Sign Holder, 48" L., Adhesive Transfer Tape	95	108604	Gripper 90 Degree Panel Former, 3/16" to 1/4" Grip, Clear	192
108570	"C" Channel Shelf Molding, 1-1/4" H., Clear with Foam Tape	37, 94	108604W	Gripper 90 Degree Panel Former, 3/16" to 1/4" Grip, White	192
108570B	"C" Channel Shelf Molding, 1-1/4" H., Black with Foam Tape	37, 94	108605	Hinged Gripper Panel Former, 1" L.	193
108570T	"C" Channel Shelf Molding, 1-1/4" H., Clear with Adhesive Transfer Tape	37, 94	108606	Hinged Gripper Panel Former, 3" L.	193
108570W	"C" Channel Shelf Molding, 1-1/4" H., White with Foam Tape	37, 94	108607	Hinged Gripper Panel Former, 48" L.	193
108571	Gripper 90 Degree Two-Way Panel Former	194	108608	Info Strip Universal Flush Sign Holder	120
108572	"C" Channel Shelf Molding, 2" H., Clear with Foam Tape	37, 94	108609	Gripper "H" Clip, 1" L.	138, 195
108572W	"C" Channel Shelf Molding, 2" H., White with Foam Tape	37, 94	108610	Gripper "H" Clip, 1-1/2" L.	138, 195
108573	Flip-Up Covered Face Sign Holder, 3-1/2" H.	32	108612	Heavy Duty Gripper Flush Sign Holder, 48" L.	122
108574	Spiral "Break-Away" Sign Holder, 17" L., White	93	108613	Extruded Hinge With Adhesive	195
108575	Spiral "Break-Away" Sign Holder, 24" L., White	93	108615	Gripper 60 Degree Panel Former, 1/8" to 3/16" Grip, Clear	192
108576	Spiral "Break-Away" Sign Holder, 30" L., White	93	108615W	Gripper 60 Degree Panel Former, 1/8" to 3/16" Grip, White	192
108577	Spiral "Break-Away" Sign Holder, 48" L., White	93	108616	Gripper 60 Degree Panel Former, 3/16" to 1/4" Grip, Clear	192
108577B	Spiral "Break-Away" Sign Holder, 48" L., Black	93	108616W	Gripper 60 Degree Panel Former, 3/16" to 1/4" Grip, White	192
108579	Gripper Scan Plate Flag Holder	133	108617	Double Wire Shelf "C" Channel, White	35
108580	Gripper Display Sign Holder	193	108617B	Double Wire Shelf "C" Channel, Black	35
108581	Gripper 60 Degree Two-Way Panel Former	194	108618	Gripper Flush Sign Holder, 48" L.	122
108582	Hinged Gripper Square Edge Sign Holder	148			

ITEM #	DESCRIPTION	PAGE #	ITEM #	DESCRIPTION	PAGE #
108621	Heavy Duty Self-Adhesive Info Strip	28	108671	Hinged Gripper Concealed Panel Former, 3/16" to 1/4" Grip, Clear	193
108623	Universal Adjustable Flush Grippers, Retail Environment, 3" L., .100" to .187" Grip	147	108671W	Hinged Gripper Concealed Panel Former, 3/16" to 1/4" Grip, White	193
108624	Universal Adjustable Flush Grippers, Retail Environment, 6" L., .100" to .187" Grip	147	108674	Flip-Up Covered Face Sign Holder, 4" H.	32
108625	Self-Adhesive Info Strip, 1-1/4" H., Clear	28	108675	Self-Adhesive Info Strip, 3" H., Clear	28
108625B	Self-Adhesive Info Strip, 1-1/4" H., Black	28	108676	Notched Gripper Wire Flush Sign Holder, 1-3/8" W.	136
108625W	Self-Adhesive Info Strip, 1-1/4" H., White	28	108677	Notched Gripper Wire Flush Sign Holder, 2-1/2" W.	136
108626	Self-Adhesive Info Strip, 2" H., Clear	28	108678	Double Curved "C" Channel For Shelf Channel	30
108627	Self-Adhesive Info Strip, 1-3/4" H., Clear	28	108679	Info Strip Label Holder For Wood Shelving, 2" L., 1" thru 1-1/8" Shelf Thickness	35
108631	"J" Channel With Adhesive, up to .250" Grip, Clear, Foam Tape	94	108680	Info Strip Label Holder For Wood Shelving, 48" L., 1" thru 1-1/8" Shelf Thickness	35
108631B	"J" Channel With Adhesive, up to .250" Grip, Black, Foam Tape	94	108681	Below Shelf Sign Holder, 3-1/2" H., 5-1/2" L.	33
108631W	"J" Channel With Adhesive, up to .250" Grip, White, Foam Tape	94	108682	Below Shelf Sign Holder, 3-1/2" H., 48" L.	33
108632	Wide Base Gripper Sign Holder	115	108683	Gripper Long Leg Shelf Channel Sign Holder	123
108633	"L" Style Sign Holder With Adhesive, 3-1/2" L.	166	108684	"C" Channel Shelf Molding, 4" H., Clear with Foam Tape	37, 94
108634	"L" Style Sign Holder With Adhesive, 6" L.	166	108684W	"C" Channel Shelf Molding, 4" H., White with Foam Tape	37, 94
108635	Universal Adjustable Flush Grippers, Warehouse Environment, 3" L., .100" to .187" Grip	147	108685	Crystal Wood Shelf Ticket Holder, 2-7/8" L.	44
108636	Universal Adjustable Flush Grippers, Warehouse Environment, 6" L., .100" to .187" Grip	147	108686	Crystal Wood Shelf Ticket Holder, 3-1/8" L.	44
108637	Gripper UPC Tag/Sign Holder	123	108688	"L" Bracket, 3" L., No Adhesive	195
108638	Gripper Shelf Channel Sign Holder, 1/2" L.	123	108689	"L" Bracket, 48" L., No Adhesive	195
108639	Gripper Shelf Channel Sign Holder, 1" L.	123	108690	"C" Channel Shelf Molding, 3" H., Clear with Foam Tape	37, 94
108640	Universal Adjustable Flush Grippers, Retail Environment, 3" L., up to .100" Grip	147	108690W	"C" Channel Shelf Molding, 3" H., White with Foam Tape	37, 94
108641	Universal Adjustable Flush Grippers, Retail Environment, 6" L., up to .100" Grip	147	108691	Crystal Easel Ticket Holder	167
108642	Universal Adjustable Flush Grippers, Warehouse Environment, 3" L., up to .100" Grip	147	108692W	Info Strip For Cooler/Freezer Shelving	35
108643	Universal Adjustable Flush Grippers, Warehouse Environment, 6" L., up to .100" Grip	147	108693	Spiral "Break-Away" Sign Holder, 12" L., White	93
108644	Self-Adhesive Info Strip With Guidebar, 47-5/8" L.	28	108695	Info Strip Label Holder For Scan Hook, 2" L., 7 Gauge Wire Size	47
108653	Gripper Covered-Face Sign Holder	118	108696	Info Strip Label Holder For Small Scan Plate	46
108656	Extra Duty Info Strip Label Holder For Wire Basket, 2" L.	41	108697	Info Strip Label Holder For Metal Scan Plate	46
108657	Extra Duty Info Strip Label Holder For Wire Basket, 46-1/4" L.	41	108698	Crystal Ticket Holder, 2-7/8" L.	44
108658	Extra Duty Info Strip Label Holder For Wire Basket, 2-1/2" L.	41	108699	Economy Info Strip Hinged Flush Sign Holder	120
108664	Perf Shelf Flush Sign Holder With Adhesive	122	108703	Flip-Up "C" Channel Header	32
108665	Gripper Wire Flag Sign Holder, .250" Wire Dia. Capacity	137	108704	"L" Bracket, 3" L., With Adhesive	195
108666	Self-Adhesive Info Strip, 1-1/2" H., Clear	28	108705	"L" Bracket, 48" L., With Adhesive	195
108666W	Self-Adhesive Info Strip, 1-1/2" H., White	28	108706	Clear UPC Tag Holder, with Plastic Overlap Rings	41
108667	Perf Shelf Gripper Flush Sign Holder	121	108707	Clear UPC Tag Holder, with Plastic Spiral Rings	41
108668	Extruded Front Fence, 36" L.	69	108708	Clear UPC Tag Holder, with Cable Ties	41
108669	Extruded Front Fence, 48" L.	69	108713	Magnetic Gripper Sign Holder, No Hinge, .125" to .250" Grip	116
108670	Hinged Gripper Concealed Panel Former, 1/8" to 3/16" Grip, Clear	193	108719	Gripper Hinged Flag Sign Holder For Wire	138
108670W	Hinged Gripper Concealed Panel Former, 1/8" to 3/16" Grip, White	193	108721	Gripper Display Track	36
			108723	Gripper Dual Panel Holder	193

ITEM #	DESCRIPTION	PAGE #	ITEM #	DESCRIPTION	PAGE #
108724	Premium Pole Gripper - Flush, With Holes	200	108787	Gripper Square Bin Flush Sign Holder	120
108725	Premium Pole Gripper - Flush, With Adhesive	200	108791	Spiral Dual-Channel Sign Holder, 24" L., White	93
108726	Easy-Flex Shelf Channel Sign Holder	124	108792	Spiral Dual-Channel Sign Holder, 30" L., White	93
108727	Gripper 90 Degree Four-Way Panel Former	194	108793	Spiral Dual-Channel Sign Holder, 48" L., White	93
108728	Gripper Shovel Base Sign Holder	118	108793B	Spiral Dual-Channel Sign Holder, 48" L., Black	93
108730	Gripper Flush Sign Holder For Slatwall	206	108794	Gripper Covered-Face Sign Holder/Protector	119
108733W	Legged Snap-In Info Strip	30	108795	Flip-Up Double-Slot Sign Holder	32
108735W	Flip-Up Snap-In Info Strip	31	108800	Angled Economy Info Strip Label Holder	29
108736	Info Strip Label Holder For Scan Hook, 3-1/2" L., 7 Gauge Wire Size	47	108801	Self-Adhesive Info Strip, 2-1/2" H., Clear	28
108737	Two-Way Sign Clip	145	108803	Flip Info Strip Label Holder For T-Scan Hook, 3-1/2" L.	45
108742	Flip Info Strip Label Holder For T-Scan Hook, 2" L.	45	108807	Flip-Up Covered Face Sign Holder, 1-1/4" H.	32
108743	Flip Info Strip Label Holder For T-Scan Hook, 3" L.	45	108810	Flip Info Strip Label Holder For T-Scan Hook, 2-1/2" L.	45
108744	Hinged Gripper Square Shelf Flush Sign Holder, for 3/4" thru 1" Shelves	119	108812	Info Strip Gripper Flag Sign Holder, Angled	131
108751	Hinged Gripper Sign Holder, 22" L., up to .100" Grip	115	108813	Price Channel Gripper Flag Sign Holder, Angled	130
108752	Hinged Gripper Sign Holder, 22" L., .125" to .187" Grip	115	108816	Info Strip Label Holder For Wood Shelving, 2" L., 5/8" thru 3/4" Shelf Thickness	35
108753	Gripper Square Shelf Flush Sign Holder, for 1/2" thru 5/8" Shelves	119	108817	Info Strip Label Holder For Wood Shelving, 48" L., 5/8" thru 3/4" Shelf Thickness	35
108754	Gripper Square Shelf Flush Sign Holder, for 3/4" thru 1" Shelves	119	108822	Contoured Front Fence	69
108755	Gripper L-Style Table Top Sign Holder	166	108827	Info Strip Label Holder For Scan Hook, 2" L., 4 Gauge Wire Size	47
108756	Two-Way Gripper Sign Holder	133	108828	Info Strip Label Holder For Scan Hook, 3" L., 4 Gauge Wire Size	47
108757B	Snap-In Gripper Info Strip, 1-1/4" H., Black Backing	29	108829	Crystal Ticket Holder, 2" L.	44
108757C	Snap-In Gripper Info Strip, 1-1/4" H., Clear Backing	29	108835B	Dual-Purpose Info Strip Label Holder For Slotted Shelf, 35-7/8" L.	35
108757W	Snap-In Gripper Info Strip, 1-1/4" H., White Backing	29	108838	P.O.P. Sign Holder With Clips	41
108760	Economy Covered-Face Center Mount Sign Holder	127	108839	Spiral Sign Board, 34" L. x 20-3/8" H., White	92, 250
108761W	Heavy Duty Self-Adhesive Info Strip	28	108844	Gourmet Clip Tag Holder	144
108767	Contoured Low Profile Front Fence	69	108845	Info Strip Label Holder For Multiple Scan Hooks	45
108770	Pole Gripper Sign Holder, for Large Poles	200	108849B	Flip-Up Double Wire Shelf Info Strip With "C" Channel, 22" L.	34
108774W	Clip-On Info Strip Label Holder	33	108850B	Flip-Up Double Wire Shelf Info Strip With "C" Channel, 27-1/2" L.	34
108775	Hinged Gripper Flush Mount Sign Holder, 3" L., .100" to .250" Grip	118	108857	Angled Info Strip With Gripper	30
108776	Hinged Gripper Flush Mount Sign Holder, 48" L., .100" to .250" Grip	118	108866	Gripper Extended Sign Holder	132
108777C	Snap-In Gripper Info Strip, 1-3/8" H., Clear Backing	29	108868	Wire Grid Sign Holder	136
108778	Self-Adhesive Gripper Info Strip	28	108869	Crystal Glass Shelf Ticket Holder	44
108779	Gripper Flip-Up Info Strip Label Holder For Scan Hooks	45	108881	Hinged "C" Channel Covered-Face Sign Holder	127
108784	Info Strip Label Holder For Scan Hook, 3" L., 7 Gauge Wire Size	47	108882	Info Strip Multi-Position Flag Sign Holder	132
108785B	Snap-In Info Strip, 1-1/4" H., Black	29	108884B	Dual-Purpose Info Strip Label Holder For Slotted Shelf, 47-7/8" L.	35
108785C	Snap-In Info Strip, 1-1/4" H., Clear	29	108893	Easel Card Holder	168
108785W	Snap-In Info Strip, 1-1/4" H., White	29	108897	Gripper Hinged Flush Sign Holder For Wire	138
108786	Flip Info Strip Gripper Label Holder For T-Scan Hook	46	108898	Info Strip Hinged Angled Style Universal Flag Sign Holder	131
			108900	Ratchet-Style Deli Sign Clip	144

ITEM #	DESCRIPTION	PAGE #	ITEM #	DESCRIPTION	PAGE #
108917	Ceiling Fan Sign Gripper	120	109053	Elastic Barbed Cord, 3" L., White	255
108930	Dual-Purpose Flip-Up Label Holder	12, 45	109053B	Elastic Barbed Cord, 3" L., Black	255
108953W	Snap-In Info Strip, 2" H., White	29	109054	Elastic Barbed Cord, 4" L., White	255
108981	Hinged "U" Channel Gripper Sign Holder	121	109054B	Elastic Barbed Cord, 4" L., Black	255
109001	Barbed Cord, 1" L., White	254	109056	Elastic Barbed Cord, 6" L., White	255
109001B	Barbed Cord, 1" L., Black	254	109056B	Elastic Barbed Cord, 6" L., Black	255
109001C	Barbed Cord, 1" L., Clear	254	109058	Elastic Barbed Cord, 8" L., White	255
109002	Barbed Cord, 2" L., White	254	109058B	Elastic Barbed Cord, 8" L., Black	255
109002B	Barbed Cord, 2" L., Black	254	109060	Elastic Barbed Cord, 10" L., White	255
109002C	Barbed Cord, 2" L., Clear	254	109060B	Elastic Barbed Cord, 10" L., Black	255
109003	Barbed Cord, 3" L., White	254	109062	Elastic Barbed Cord, 12" L., White	255
109003B	Barbed Cord, 3" L., Black	254	109062B	Elastic Barbed Cord, 12" L., Black	255
109003C	Barbed Cord, 3" L., Clear	254	109068	Elastic Barbed Cord, 18" L., White	255
109004	Barbed Cord, 4" L., White	254	109068B	Elastic Barbed Cord, 18" L., Black	255
109004B	Barbed Cord, 4" L., Black	254	109500	Four-Wire Top Insert Label Holder For Scan Hooks	47
109004C	Barbed Cord, 4" L., Clear	254	109502	Four-Wire Label Holder For Scan Hooks	47
109006	Barbed Cord, 6" L., White	254	109505	K-Ads Shopping Cart Sign Frame	87
109006B	Barbed Cord, 6" L., Black	254	109506B	Spiral Sign Board, 34" L. x 20-3/8" H., White	92, 250
109006C	Barbed Cord, 6" L., Clear	254	109508	Single Prong All-Wire Pegboard Hook, .149" Dia., 2" L.	51
109008	Barbed Cord, 8" L., White	254	109509	All-Wire Pegboard Hook With T-Scan Bar, .186" Dia., 11" L.	50
109008B	Barbed Cord, 8" L., Black	254	109510	Extra Heavy-Duty Magnetic Hook	80, 261
109008C	Barbed Cord, 8" L., Clear	254	109511	Pin-Up Hook	54
109010	Barbed Cord, 10" L., White	254	109512W	Economy Squeegee Applicator	169
109010B	Barbed Cord, 10" L., Black	254	109513	Self-Piercing Covered Ticket Holder	42
109010C	Barbed Cord, 10" L., Clear	254	109514	Modular Display Pole Shelf Support	199
109012	Barbed Cord, 12" L., White	254	109515	Modular Display Pole Shelf Support Cap	199
109012B	Barbed Cord, 12" L., Black	254	109517	Plastic "S" Hook Merchandiser	80
109012C	Barbed Cord, 12" L., Clear	254	109519	Top Sign Holder For Display Poles	199
109018	Barbed Cord, 18" L., White	254	109520	Perf Shelf Plastic Loop Fastener	209
109018B	Barbed Cord, 18" L., Black	254	109521	Square Edge Power Wing Clip	206
109018C	Barbed Cord, 18" L., Clear	254	109522	Packaging Handles, Light Duty, White	191
109024	Barbed Cord, 24" L., White	254	109522B	Packaging Handles, Light Duty, Black	191
109024B	Barbed Cord, 24" L., Black	254	109523	Packaging Handles, Medium Duty, White	191
109024C	Barbed Cord, 24" L., Clear	254	109524B	Packaging Handles, Heavy Duty, Black	191
109036	Barbed Cord, 36" L., White	254	109525	Round Backer Washer For Packaging Handles	191
109036B	Barbed Cord, 36" L., Black	254	109526	Stop Lock For Stem Hooks, Red	63
109036C	Barbed Cord, 36" L., Clear	254	109526B	Stop Lock For Stem Hooks, Black	63
109051	Elastic Barbed Cord, 1" L., White	255	109527	Magnetic Key For Stop Locks	63
109051B	Elastic Barbed Cord, 1" L., Black	255	109529B	Magnetic Flush-Style Adapter Base For Aisle Sign Arms	153
109052	Elastic Barbed Cord, 2" L., White	255	109531	"Y" Drop Style Cable Assemblies, Toggle End	270
109052B	Elastic Barbed Cord, 2" L., Black	255			

ITEM #	DESCRIPTION	PAGE #	ITEM #	DESCRIPTION	PAGE #
109537	"Y" Drop Style Cable Assemblies, Snap Hook End	270	110503B	Banner Hanger Clip, Black	236, 241
109543	Universal Three-Sided Mobile Kit	251	110503W	Banner Hanger Clip, White	236, 241
109544	Display Caster With Adhesive, 1" Round	197	110504B	Aluminum Banner Joiner Hanger Clip	239
109545	Shelf-Top Swivel Merchandising Strip Hanger	78	110505B	Round or Square Economy Banner Joiner	243-245
109547	Pegboard Hook Overlays, Fits 4" to 5" L. Hooks	48	110506	Banner Hanger Clip With Hook, Clear	237, 241
109548	Pegboard Hook Overlays, Fits 6" to 7" L. Hooks	48	110506B	Banner Hanger Clip With Hook, Black	237, 241
109549	Pegboard Hook Overlays, Fits 8" to 9" L. Hooks	48	110506W	Banner Hanger Clip With Hook, White	237, 241
109550	Pegboard Hook Overlays, Fits 10" to 11" L. Hooks	48	110507	Valance Clip	247
109556	Freestanding Sign Holder With Pocket	177	110508	Space General End Cap, Silver	241
109559	All-Wire Pegboard Hook With Gripper	61	110508B	Space General End Cap, Black	241
109564	Multi-Purpose Sign Holder	145	110508C	Space General End Cap, Clear	241
109571	Indoor/Outdoor Spring Base Floor Stand	91	110511	Clip For P.O.P. Sign Holder	41
109595	Four-Wire Label Holder For Scan Hooks	47	110600W	Atlas Banner Hanger, 22" L., White	236
109626	Stop Lock For Loop Hooks	14, 63	110601W	Atlas Banner Hanger, 24" L., White	236
109650	Heavy-Duty Pegboard Hook Overlay	13, 48	110602W	Atlas Banner Hanger, 36" L., White	236
109661	Triway Mobile Kit, 20" to 40" with Ceiling Twist Clip & Cord	251	110603B	Atlas Banner Hanger, 48" L., Black	236
110017B	Round Graphic/Banner Hanger, 36" L.	242	110603W	Atlas Banner Hanger, 48" L., White	236
110018B	Round Graphic/Banner Hanger, 48" L.	242	110700	Gripper Apollo Banner Hanger, 22" L., Clear	237
110019B	Round Graphic/Banner Hanger, 72" L.	242	110701	Gripper Apollo Banner Hanger, 24" L., Clear	237
110020B	Square Graphic/Banner Hanger, 72" L.	244	110702	Gripper Apollo Banner Hanger, 36" L., Clear	237
110021B	Square Graphic/Banner Hanger, 36" L.	244	110703	Gripper Apollo Banner Hanger, 48" L., Clear	237
110022B	Square Graphic/Banner Hanger, 48" L.	244	110703B	Gripper Apollo Banner Hanger, 48" L., Black	237
110023	Elliptical Banner Hanger - Aluminum, 24" L.	238	110720	Gripper Apollo Banner Hanger With Adhesive, 22" L., Clear	95
110024	Elliptical Banner Hanger - Aluminum, 36" L.	238	110721	Gripper Apollo Banner Hanger With Adhesive, 24" L., Clear	95
110025	Elliptical Banner Hanger - Aluminum, 48" L.	238	110721B	Gripper Apollo Banner Hanger With Adhesive, 24" L., Black	95
110026	Front Load Plastic Sign Frame Rail, Silver	95	110722	Gripper Apollo Banner Hanger With Adhesive, 36" L., Clear	95
110026B	Front Load Plastic Sign Frame Rail, Black	95	110722B	Gripper Apollo Banner Hanger With Adhesive, 36" L., Black	95
110026C	Front Load Plastic Sign Frame Rail, Clear	95	110723	Gripper Apollo Banner Hanger With Adhesive, 48" L., Clear	95
110027	Instant Flag Gripper Display Tube, 12" L.	149	110723B	Gripper Apollo Banner Hanger With Adhesive, 48" L., Black	95
110028	Instant Flag Gripper Display Tube, 24" L.	149	110724	Gripper Apollo Banner Hanger With Adhesive, 3" L., Clear	95
110050	Instant Flag Slitted Display Tube, 12" L.	149	110731	Snap-Shut Banner Hanger, 24" L.	246
110051	Instant Flag Slitted Display Tube, 24" L.	149	110732	Snap-Shut Banner Hanger, 36" L.	246
110322C	Elliptical Banner Hanger - Plastic, 22" L.	240	110733	Snap-Shut Banner Hanger, 48" L.	246
110324C	Elliptical Banner Hanger - Plastic, 24" L.	240	110736	Gripper Apollo Banner Hanger With Suction Cups, 22" L.	96
110336C	Elliptical Banner Hanger - Plastic, 36" L.	240	110738	Gripper Apollo Banner Hanger With Suction Cups, 36" L.	96
110348C	Elliptical Banner Hanger - Plastic, 48" L.	240	110740	Gripper Apollo Designer Series Banner Hanger, 22" L., Clear	237
110500B	Elliptical End Cap	238	110740B	Gripper Apollo Designer Series Banner Hanger, 22" L., Black	237
110502	Elliptical Banner Hanger Clip, Clear	238, 240	110741	Gripper Apollo Designer Series Banner Hanger, 24" L., Clear	237
110502B	Elliptical Banner Hanger Clip, Black	238, 240			
110503	Banner Hanger Clip, Clear	236, 241			

ITEM #	DESCRIPTION	PAGE #	ITEM #	DESCRIPTION	PAGE #
110741B	Gripper Apollo Designer Series Banner Hanger, 24" L., Black	237	110814B	Gripper Budget Banner Hanger/Stabilizer, 48" L., Black	247
110742	Gripper Apollo Designer Series Banner Hanger, 36" L., Clear	237	110815	Budget "U" Channel Gripper Sign Holder, 1/4" Base W., .015" to .080" Grip	194
110742B	Gripper Apollo Designer Series Banner Hanger, 36" L., Black	237	110816	Budget "U" Channel Gripper Sign Holder, 3/8" Base W., .125" to .187" Grip	194
110742W	Gripper Apollo Designer Series Banner Hanger, 36" L., White	237	110825	Simple Banner Hanger, 22" L., Clear	246
110743	Gripper Apollo Designer Series Banner Hanger, 48" L., Clear	237	110825W	Simple Banner Hanger, 22" L., White	246
110743B	Gripper Apollo Designer Series Banner Hanger, 48" L., Black	237	110826	Simple Banner Hanger, 24" L., Clear	246
110743W	Gripper Apollo Designer Series Banner Hanger, 48" L., White	237	110826W	Simple Banner Hanger, 24" L., White	246
110746	Space General Banner Hanger, 24" L., Silver	241	110827	Simple Banner Hanger, 36" L., Clear	246
110746B	Space General Banner Hanger, 24" L., Black	241	110827W	Simple Banner Hanger, 36" L., White	246
110746C	Space General Banner Hanger, 24" L., Clear	241	110828	Simple Banner Hanger, 48" L., Clear	246
110747	Space General Banner Hanger, 36" L., Silver	241	110828W	Simple Banner Hanger, 48" L., White	246
110747B	Space General Banner Hanger, 36" L., Black	241	110850	Gripper Simple Banner Hanger, 22" L., Clear	246
110747C	Space General Banner Hanger, 36" L., Clear	241	110851	Gripper Simple Banner Hanger, 24" L., Clear	246
110748	Space General Banner Hanger, 48" L., Silver	241	110852	Gripper Simple Banner Hanger, 36" L., Clear	246
110748B	Space General Banner Hanger, 48" L., Black	241	110853	Gripper Simple Banner Hanger, 48" L., Clear	246
110748C	Space General Banner Hanger, 48" L., Clear	241	110853B	Gripper Simple Banner Hanger, 48" L., Black	246
110751	Gripper Apollo Insert, 24" L.	239	116101	Slide-On Gripper Sign Holder, 3" L., With Hinge, up to .100"	20, 108
110752	Gripper Apollo Insert, 36" L.	239	116102	Slide-On Gripper Sign Holder, 3" L., With Hinge, .100" to .250"	20, 108
110753	Gripper Apollo Insert, 48" L.	239	116103	Slide-On Gripper Sign Holder, 3" L., No Hinge, up to .100"	20, 108
110800	Gripper Atlas Banner Hanger, .015" to .080" Grip, 22" L.	236	116104	Slide-On Gripper Sign Holder, 3" L., No Hinge, .100" to .250"	20, 108
110801	Gripper Atlas Banner Hanger, .015" to .080" Grip, 24" L.	236	116106	Slide-On Gripper Sign Holder, Offset Style, 3" L., With Hinge, up to .100"	20, 108
110802	Gripper Atlas Banner Hanger, .015" to .080" Grip, 36" L.	236	116109	Slide-On Gripper Sign Holder, Offset Style, 3" L., With Hinge, .100" to .250"	20, 108
110803	Gripper Atlas Banner Hanger, .015" to .080" Grip, 48" L.	236	116200	Warehouse Upright Bracket	24, 112
110804	Budget Banner Hanger/Stabilizer, 22" L., Clear	247	116230	Warehouse Upright Bracket For Square Holes	24, 112
110805	Budget Banner Hanger/Stabilizer, 24" L., Clear	247	116300	Gondola Upright Bracket	24, 112
110806	Budget Banner Hanger/Stabilizer, 36" L., Clear	247	116400	Shelf-Top Bracket, Beige	21, 108
110806W	Budget Banner Hanger/Stabilizer, 36" L., White	247	116400B	Shelf-Top Bracket, Black	21, 108
110807	Budget Banner Hanger/Stabilizer, 48" L., Clear	247	116460	Slatwall Bracket	24, 111
110807W	Budget Banner Hanger/Stabilizer, 48" L., White	247	116500	Pegboard Bracket	23, 111
110808	Gripper Atlas Banner Hanger, .125" to .250" Grip, 22" L.	236	116600	Channel Mount Bracket	21, 109
110809	Gripper Atlas Banner Hanger, .125" to .250" Grip, 36" L.	236	116621	Channel Mount Gripper Sign Holder - Metal, Phillips Pan Head Screw, With Hinge, up to .100" Grip	101
110810	Gripper Atlas Banner Hanger, .125" to .250" Grip, 48" L.	236	116622	Channel Mount Gripper Sign Holder - Metal, Phillips Pan Head Screw, With Hinge, .100" to .250" Grip	101
110811	Gripper Budget Banner Hanger/Stabilizer, 22" L., Clear	247	116623	Channel Mount Gripper Sign Holder - Metal, Phillips Pan Head Screw, No Hinge, up to .100" Grip	101
110812	Gripper Budget Banner Hanger/Stabilizer, 24" L., Clear	247	116624	Channel Mount Gripper Sign Holder - Metal, Phillips Pan Head Screw, No Hinge, .100" to .250" Grip	101
110813	Gripper Budget Banner Hanger/Stabilizer, 36" L., Clear	247	116700	Under-Shelf Bracket, Spring-Mount	22, 110
110814	Gripper Budget Banner Hanger/Stabilizer, 48" L., Clear	247			



ITEM #	DESCRIPTION	PAGE #	ITEM #	DESCRIPTION	PAGE #
116800	Metal Shelf-Top Bracket	21, 78, 108	120209B	X-Mas Tree Clip Fastener, Fin Type "X", .234" Hole, .945" Shank L., .500" Head O.D., Black	215
116900	Metal Telescopic Bracket, Gondola With Flip Nut, Beige	23, 111	120210	X-Mas Tree Clip Fastener, Fin Type "X", .187" Hole, .640" Shank L., .437" Head O.D., Natural	215
116900B	Metal Telescopic Bracket, Gondola With Flip Nut, Black	23, 111	120210B	X-Mas Tree Clip Fastener, Fin Type "X", .187" Hole, .640" Shank L., .437" Head O.D., Black	215
116910	Under-Shelf Bracket, Screw-Mount	22, 110	120211	X-Mas Tree Clip Fastener, Fin Type "X", .187" Hole, .560" Shank L., .337" Head O.D., Natural	215
116920	Metal Telescopic Bracket, Pegboard, Beige	23, 111	120211B	X-Mas Tree Clip Fastener, Fin Type "X", .187" Hole, .560" Shank L., .337" Head O.D., Black	215
116920B	Metal Telescopic Bracket, Pegboard, Black	23, 111	120212	X-Mas Tree Clip Fastener, Fin Type "X", .234" Hole, .500" Shank L., .609" Head O.D., Natural	215
116940	Under-Shelf Hardware-Mount Bracket	23, 110	120212B	X-Mas Tree Clip Fastener, Fin Type "X", .234" Hole, .500" Shank L., .609" Head O.D., Black	215
116960	Magnetic Under-Shelf Bracket, Beige	22, 110	120212C	X-Mas Tree Clip Fastener, Fin Type "X", .234" Hole, .500" Shank L., .609" Head O.D., Clear	215
116960B	Magnetic Under-Shelf Bracket, Black	22, 110	120213	X-Mas Tree Clip Fastener, Fin Type "R", .250" Hole, 1.060" Shank L., .700" Head O.D., Natural	214
116970	Magnetic Under-Shelf Bracket – L-Style, Beige	22, 109	120213B	X-Mas Tree Clip Fastener, Fin Type "R", .250" Hole, 1.060" Shank L., .700" Head O.D., Black	214
116970B	Magnetic Under-Shelf Bracket – L-Style, Black	22, 109	120214	X-Mas Tree Clip Fastener, Fin Type "R", .187" Hole, .680" Shank L., .437" Head O.D., Natural	214
116990	Metal Telescopic Bracket, Gondola Tool-Free, Beige	23, 111	120214B	X-Mas Tree Clip Fastener, Fin Type "R", .187" Hole, .680" Shank L., .437" Head O.D., Black	214
118729	Flush Mount Adapter With Adhesive	146	120215	X-Mas Tree Clip Fastener, Fin Type "X", .281" Hole, 1.310" Shank L., .600" Head O.D., Natural	215
120200	X-Mas Tree Clip Fastener, Fin Type "X", .250" Hole, .500" Shank L., .750" Head O.D., Natural	215	120215B	X-Mas Tree Clip Fastener, Fin Type "X", .281" Hole, 1.310" Shank L., .600" Head O.D., Black	215
120200B	X-Mas Tree Clip Fastener, Fin Type "X", .250" Hole, .500" Shank L., .750" Head O.D., Black	215	120216	X-Mas Tree Clip Fastener, Fin Type "X", .281" Hole, .703" Shank L., .937" Head O.D., Natural	215
120200C	X-Mas Tree Clip Fastener, Fin Type "X", .250" Hole, .500" Shank L., .750" Head O.D., Clear	215	120216B	X-Mas Tree Clip Fastener, Fin Type "X", .281" Hole, .703" Shank L., .937" Head O.D., Black	215
120201	X-Mas Tree Clip Fastener, Fin Type "X", .250" Hole, 1.440" Shank L., 1.000" Head O.D., Natural	215	120217	X-Mas Tree Clip Fastener, Fin Type "X", .281" Hole, 1.190" Shank L., 1.250" Head O.D., Natural	215
120201B	X-Mas Tree Clip Fastener, Fin Type "X", .250" Hole, 1.440" Shank L., 1.000" Head O.D., Black	215	120217B	X-Mas Tree Clip Fastener, Fin Type "X", .281" Hole, 1.190" Shank L., 1.250" Head O.D., Black	215
120202	X-Mas Tree Clip Fastener, Fin Type "X", .281" Hole, 1.260" Shank L., .760" Head O.D., Natural	215	120218	X-Mas Tree Clip Fastener, Fin Type "X", .187" Hole, .700" Shank L., .470" Head O.D., Natural	215
120202B	X-Mas Tree Clip Fastener, Fin Type "X", .281" Hole, 1.260" Shank L., .760" Head O.D., Black	215	120218B	X-Mas Tree Clip Fastener, Fin Type "X", .187" Hole, .700" Shank L., .470" Head O.D., Black	215
120203	X-Mas Tree Clip Fastener, Fin Type "X", .281" Hole, .745" Shank L., .625" Head O.D., Natural	215	120219	Double End X-Mas Tree Fastener, 1.350" L., Natural	212
120203B	X-Mas Tree Clip Fastener, Fin Type "X", .281" Hole, .745" Shank L., .625" Head O.D., Black	215	120219B	Double End X-Mas Tree Fastener, 1.350" L., Black	212
120204B	Double Barbed Graphic Fastener	212, 243, 245	120220	X-Mas Tree Clip Fastener, Fin Type "R", .187" Hole, .480" Shank L., .437" Head O.D., Round Head, Natural	214
120205	X-Mas Tree Clip Fastener, Fin Type "R", .250" Hole, .802" Shank L., .700" Head O.D., Natural	214	120220B	X-Mas Tree Clip Fastener, Fin Type "R", .187" Hole, .480" Shank L., .437" Head O.D., Round Head, Black	214
120205B	X-Mas Tree Clip Fastener, Fin Type "R", .250" Hole, .802" Shank L., .700" Head O.D., Black	214	120221	X-Mas Tree Clip Fastener, Fin Type "R", .125" Hole, .308" Shank L., .240" Head O.D., Natural	215
120205C	X-Mas Tree Clip Fastener, Fin Type "R", .250" Hole, .802" Shank L., .700" Head O.D., Clear	214	120221B	X-Mas Tree Clip Fastener, Fin Type "R", .125" Hole, .308" Shank L., .240" Head O.D., Black	215
120205W	X-Mas Tree Clip Fastener, Fin Type "R", .250" Hole, .802" Shank L., .700" Head O.D., White	214	120222	X-Mas Tree Clip Fastener, Fin Type "X", .312" Hole, .660" Shank L., .500" Head O.D., Natural	215
120206	X-Mas Tree Clip Fastener, Fin Type "X", .203" Hole, .700" Shank L., .750" Head O.D., Natural	215	120222B	X-Mas Tree Clip Fastener, Fin Type "X", .312" Hole, .660" Shank L., .500" Head O.D., Black	215
120206B	X-Mas Tree Clip Fastener, Fin Type "X", .203" Hole, .700" Shank L., .750" Head O.D., Black	215	120223	X-Mas Tree Clip Fastener, Fin Type "R", .394" Hole, 1.110" Shank L., .846" Head O.D., Natural	214
120207	X-Mas Tree Clip Fastener, Fin Type "X", .156" Hole, .531" Shank L., .375" Head O.D., Natural	215	120223B	X-Mas Tree Clip Fastener, Fin Type "R", .394" Hole, 1.110" Shank L., .846" Head O.D., Black	214
120207B	X-Mas Tree Clip Fastener, Fin Type "X", .156" Hole, .531" Shank L., .375" Head O.D., Black	215			
120208	X-Mas Tree Clip Fastener, Fin Type "X", .187" Hole, .438" Shank L., .437" Head O.D., Natural	215			
120208B	X-Mas Tree Clip Fastener, Fin Type "X", .187" Hole, .438" Shank L., .437" Head O.D., Black	215			
120209	X-Mas Tree Clip Fastener, Fin Type "X", .234" Hole, .945" Shank L., .500" Head O.D., Natural	215			

ITEM #	DESCRIPTION	PAGE #	ITEM #	DESCRIPTION	PAGE #
120224	X-Mas Tree Clip Fastener, Fin Type "R", .406" Hole, .820" Shank L., 1.00" Head O.D., Natural	214	120242	X-Mas Tree Clip Fastener, Fin Type "X", .250" Hole, 1.065" Shank L., .750" Head O.D., Natural	215
120224B	X-Mas Tree Clip Fastener, Fin Type "R", .406" Hole, .820" Shank L., 1.00" Head O.D., Black	214	120242B	X-Mas Tree Clip Fastener, Fin Type "X", .250" Hole, 1.065" Shank L., .750" Head O.D., Black	215
120225	X-Mas Tree Clip Fastener, Fin Type "R", .281" Hole, 1.200" Shank L., .750" Head O.D., Natural	214	120243	X-Mas Tree Clip Fastener, Fin Type "R", .218" Hole, .500" Shank L., .650" Head O.D., Natural	214
120225B	X-Mas Tree Clip Fastener, Fin Type "R", .281" Hole, 1.200" Shank L., .750" Head O.D., Black	214	120243B	X-Mas Tree Clip Fastener, Fin Type "R", .218" Hole, .500" Shank L., .650" Head O.D., Black	214
120226	X-Mas Tree Clip Fastener, Fin Type "R", .250" Hole, .610" Shank L., .700" Head O.D., Natural	214	120244	X-Mas Tree Clip Fastener, Fin Type "P", .197" Hole, .496" Shank L., .433" Head O.D., Natural	213
120226B	X-Mas Tree Clip Fastener, Fin Type "R", .250" Hole, .610" Shank L., .700" Head O.D., Black	214	120244B	X-Mas Tree Clip Fastener, Fin Type "P", .197" Hole, .496" Shank L., .433" Head O.D., Black	213
120227B	X-Mas Tree Clip Fastener, Fin Type "R", .343" Hole, .752" Shank L., .630" Head O.D., Black	214	120245	X-Mas Tree Clip Fastener, Fin Type "P", .118" Hole, .386" Shank L., .216" Head O.D., Natural	213
120228	X-Mas Tree Clip Fastener, Fin Type "R", .156" Hole, .432" Shank L., .360" Head O.D., Natural	214	120245B	X-Mas Tree Clip Fastener, Fin Type "P", .118" Hole, .386" Shank L., .216" Head O.D., Black	213
120228B	X-Mas Tree Clip Fastener, Fin Type "R", .156" Hole, .432" Shank L., .360" Head O.D., Black	214	120246	X-Mas Tree Clip Fastener, Fin Type "P", .312" Hole, .895" Shank L., .752" Head O.D., Natural	213
120229	X-Mas Tree Clip Fastener, Fin Type "R", .250" Hole, .625" Shank L., .500" Head O.D., Natural	214	120246B	X-Mas Tree Clip Fastener, Fin Type "P", .312" Hole, .895" Shank L., .752" Head O.D., Black	213
120229B	X-Mas Tree Clip Fastener, Fin Type "R", .250" Hole, .625" Shank L., .500" Head O.D., Black	214	120247	X-Mas Tree Clip Fastener, Fin Type "R", .250" Hole, 1.383" Shank L., .700" Head O.D., Natural	214
120230	X-Mas Tree Clip Fastener, Fin Type "R", .218" Hole, .774" Shank L., .650" Head O.D., Natural	214	120247B	X-Mas Tree Clip Fastener, Fin Type "R", .250" Hole, 1.383" Shank L., .700" Head O.D., Black	214
120230B	X-Mas Tree Clip Fastener, Fin Type "R", .218" Hole, .774" Shank L., .650" Head O.D., Black	214	120247W	X-Mas Tree Clip Fastener, Fin Type "R", .250" Hole, 1.383" Shank L., .700" Head O.D., White	214
120231	X-Mas Tree Clip Fastener, Fin Type "R", .281" Hole, .834" L., .748" Head O.D., Natural	214	120249	X-Mas Tree Clip Fastener, Fin Type "R", .281" Hole, 1.476" Shank L., 1.000" Head O.D., Natural	214
120231B	X-Mas Tree Clip Fastener, Fin Type "R", .281" Hole, .834" L., .748" Head O.D., Black	214	120249B	X-Mas Tree Clip Fastener, Fin Type "R", .281" Hole, 1.476" Shank L., 1.000" Head O.D., Black	214
120232	X-Mas Tree Clip Fastener, Fin Type "R", .136" Hole, .375" Shank L., .360" Head O.D., Natural	214	120252	X-Mas Tree Clip Fastener, Fin Type "R", .250" Hole, .787" Shank L., .492" Head O.D., Natural	214
120232B	X-Mas Tree Clip Fastener, Fin Type "R", .136" Hole, .375" Shank L., .360" Head O.D., Black	214	120252B	X-Mas Tree Clip Fastener, Fin Type "R", .250" Hole, .787" Shank L., .492" Head O.D., Black	214
120233	X-Mas Tree Clip Fastener, Fin Type "R", .218" Hole, .774" Shank L., .510" Head O.D., Natural	214	120254	X-Mas Tree Clip Fastener, Fin Type "P", .250" Hole, .791" Shank L., .625" Head O.D., Natural	213
120233B	X-Mas Tree Clip Fastener, Fin Type "R", .218" Hole, .774" Shank L., .510" Head O.D., Black	214	120254B	X-Mas Tree Clip Fastener, Fin Type "P", .250" Hole, .791" Shank L., .625" Head O.D., Black	213
120234	X-Mas Tree Clip Fastener, Fin Type "R", .187" Hole, .480" Shank L., .734" Head O.D., Natural	214	120255	X-Mas Tree Clip Fastener, Fin Type "P", .281" Hole, 1.311" Shank L., .748" Head O.D., Natural	213
120234B	X-Mas Tree Clip Fastener, Fin Type "R", .187" Hole, .480" Shank L., .734" Head O.D., Black	214	120255B	X-Mas Tree Clip Fastener, Fin Type "P", .281" Hole, 1.311" Shank L., .748" Head O.D., Black	213
120235	X-Mas Tree Clip Fastener, Fin Type "P", .281" Hole, 1.457" Shank L., 1.000" Head O.D., Natural	213	120257	X-Mas Tree Clip Fastener, Fin Type "P", .197" Hole, .700" Shank L., .433" Head O.D., Natural	213
120235B	X-Mas Tree Clip Fastener, Fin Type "P", .281" Hole, 1.457" Shank L., 1.000" Head O.D., Black	213	120257B	X-Mas Tree Clip Fastener, Fin Type "P", .197" Hole, .700" Shank L., .433" Head O.D., Black	213
120236	X-Mas Tree Clip Fastener, Fin Type "P", .236" Hole, .472" Shank L., .472" Head O.D., Natural	213	120258	X-Mas Tree Clip Fastener, Fin Type "P", .250" Hole, .433" Shank L., .728" Head O.D., Natural	213
120236B	X-Mas Tree Clip Fastener, Fin Type "P", .236" Hole, .472" Shank L., .472" Head O.D., Black	213	120258B	X-Mas Tree Clip Fastener, Fin Type "P", .250" Hole, .433" Shank L., .728" Head O.D., Black	213
120237	X-Mas Tree Clip Fastener, Fin Type "P", .281" Hole, .787" Shank L., 1.000" Head O.D., Natural	213	120262	X-Mas Tree Clip Fastener, Fin Type "P", .250" Hole, .749" Shank L., .728" Head O.D., Natural	213
120237B	X-Mas Tree Clip Fastener, Fin Type "P", .281" Hole, .787" Shank L., 1.000" Head O.D., Black	213	120262B	X-Mas Tree Clip Fastener, Fin Type "P", .250" Hole, .749" Shank L., .728" Head O.D., Black	213
120238	X-Mas Tree Clip Fastener, Fin Type "P", .236" Hole, .774" Shank L., .472" Head O.D., Natural	213	120263	X-Mas Tree Clip Fastener, Fin Type "P", .312" Hole, .945" Shank L., 1.000" Head O.D., Natural	213
120238B	X-Mas Tree Clip Fastener, Fin Type "P", .236" Hole, .774" Shank L., .472" Head O.D., Black	213	120263B	X-Mas Tree Clip Fastener, Fin Type "P", .312" Hole, .945" Shank L., 1.000" Head O.D., Black	213
120240	X-Mas Tree Clip Fastener, Fin Type "P", .281" Hole, 1.077" Shank L., .748" Head O.D., Natural	213	120264	X-Mas Tree Clip Fastener, Fin Type "X", .187" Hole, 1.375" Shank L., .437" Head O.D., Natural	215
120240B	X-Mas Tree Clip Fastener, Fin Type "P", .281" Hole, 1.077" Shank L., .748" Head O.D., Black	213			

ITEM #	DESCRIPTION	PAGE #	ITEM #	DESCRIPTION	PAGE #
120264B	X-Mas Tree Clip Fastener, Fin Type "X", .187" Hole, 1.375" Shank L., .437" Head O.D., Black	215	120300B	Ratchet Rivet Fastener, .750" Head O.D., .235" to .297" Grip, Black	208
120265	X-Mas Tree Clip Fastener, Fin Type "X", .250" Hole, .394" Shank L., .618" Head O.D., Natural	215	120300C	Ratchet Rivet Fastener, .750" Head O.D., .235" to .297" Grip, Clear	208
120265B	X-Mas Tree Clip Fastener, Fin Type "X", .250" Hole, .394" Shank L., .618" Head O.D., Black	215	120302	Ratchet Rivet Fastener, .750" Head O.D., .346" to .500" Grip, Natural	208
120266	X-Mas Tree Clip Fastener, Fin Type "X", .281" Hole, 2.020" Shank L., .600" Head O.D., Natural	215	120302B	Ratchet Rivet Fastener, .750" Head O.D., .346" to .500" Grip, Black	208
120266B	X-Mas Tree Clip Fastener, Fin Type "X", .281" Hole, 2.020" Shank L., .600" Head O.D., Black	215	120302C	Ratchet Rivet Fastener, .750" Head O.D., .346" to .500" Grip, Clear	208
120268	X-Mas Tree Clip Fastener, Fin Type "X", .281" Hole, .723" Shank L., .808" Head O.D., Natural	215	120303	Ratchet Rivet Fastener, .750" Head O.D., .500" to .812" Grip, Natural	208
120268B	X-Mas Tree Clip Fastener, Fin Type "X", .281" Hole, .723" Shank L., .808" Head O.D., Black	215	120303B	Ratchet Rivet Fastener, .750" Head O.D., .500" to .812" Grip, Black	208
120269	X-Mas Tree Clip Fastener, Fin Type "R", .250" Hole, 1.103" Shank L., .866" Head O.D., Natural	214	120303C	Ratchet Rivet Fastener, .750" Head O.D., .500" to .812" Grip, Clear	208
120269B	X-Mas Tree Clip Fastener, Fin Type "R", .250" Hole, 1.103" Shank L., .866" Head O.D., Black	214	120304	Ratchet Rivet Fastener, .750" Head O.D., .780" to 1.380" Grip, Natural	208
120270	X-Mas Tree Clip Fastener, Fin Type "R", .322" Hole, .736" Shank L., 1.000" Head O.D., Natural	214	120304B	Ratchet Rivet Fastener, .750" Head O.D., .780" to 1.380" Grip, Black	208
120270B	X-Mas Tree Clip Fastener, Fin Type "R", .322" Hole, .736" Shank L., 1.000" Head O.D., Black	214	120304C	Ratchet Rivet Fastener, .750" Head O.D., .780" to 1.380" Grip, Clear	208
120271	X-Mas Tree Clip Fastener, Fin Type "R", .187" Hole, .680" Shank L., .336" Head O.D., Natural	214	120305	Graphic Ratchet Fastener	208, 239
120271B	X-Mas Tree Clip Fastener, Fin Type "R", .187" Hole, .680" Shank L., .336" Head O.D., Black	214	120305B	Ratchet Rivet Fastener, .406" Head O.D., .235" to .297" Grip, Black	208
120273	X-Mas Tree Clip Fastener, Fin Type "R", .250" Hole, .790" Shank L., .551" Head O.D., Natural	214	120305C	Ratchet Rivet Fastener, .406" Head O.D., .235" to .297" Grip, Clear	208
120273B	X-Mas Tree Clip Fastener, Fin Type "R", .250" Hole, .790" Shank L., .551" Head O.D., Black	214	120307	Ratchet Rivet Fastener, .406" Head O.D., .346" to .500" Grip, Natural	208
120274	X-Mas Tree Clip Fastener, Fin Type "R", .322" Hole, .480" Shank L., .511" Head O.D., Natural	214	120307B	Ratchet Rivet Fastener, .406" Head O.D., .346" to .500" Grip, Black	208
120274B	X-Mas Tree Clip Fastener, Fin Type "R", .322" Hole, .480" Shank L., .511" Head O.D., Black	214	120307C	Ratchet Rivet Fastener, .406" Head O.D., .346" to .500" Grip, Clear	208
120275	X-Mas Tree Clip Fastener, Fin Type "R", .250" Hole, .437" Shank L., .437" Head O.D., Natural	214	120308	Ratchet Rivet Fastener, .406" Head O.D., .500" to .812" Grip, Natural	208
120275B	X-Mas Tree Clip Fastener, Fin Type "R", .250" Hole, .437" Shank L., .437" Head O.D., Black	214	120308B	Ratchet Rivet Fastener, .406" Head O.D., .500" to .812" Grip, Black	208
120276B	X-Mas Tree Clip Fastener, Fin Type "R", .187" Hole, .480" Shank L., .437" Head O.D., Flat Head, Black	214	120308C	Ratchet Rivet Fastener, .406" Head O.D., .500" to .812" Grip, Clear	208
120277B	X-Mas Tree Clip Fastener, Fin Type "X", .281" Hole, .894" Shank L., .787" Head O.D., Black	215	120309	Ratchet Rivet Fastener, .406" Head O.D., .780" to 1.380" Grip, Natural	208
120281B	X-Mas Tree Clip Fastener, Fin Type "X", .281" Hole, .945" Shank L., .500" Head O.D., Black	215	120309B	Ratchet Rivet Fastener, .406" Head O.D., .780" to 1.380" Grip, Black	208
120282B	X-Mas Tree Clip Fastener, Fin Type "R", .250" Hole, 1.275" Shank L., .700" Head O.D., Black	214	120309C	Ratchet Rivet Fastener, .406" Head O.D., .780" to 1.380" Grip, Clear	208
120286	X-Mas Tree Clip Fastener, Fin Type "R", .250" Hole, 1.760" Shank L., .700" Head O.D., Natural	214	120320	Snap Rivet Fastener, Female, Natural	208
120286B	X-Mas Tree Clip Fastener, Fin Type "R", .250" Hole, 1.760" Shank L., .700" Head O.D., Black	214	120320B	Snap Rivet Fastener, Female, Black	208
120289	X-Mas Tree Clip Fastener, Fin Type "X", .250" Hole, .887" Shank L., .496" Head O.D., Natural	215	120320C	Snap Rivet Fastener, Female, Clear	208
120289B	X-Mas Tree Clip Fastener, Fin Type "X", .250" Hole, .887" Shank L., .496" Head O.D., Black	215	120325	Snap Rivet Fastener, Male, .170" to .190" Grip, Natural	208
120291B	X-Mas Tree Clip Fastener, Fin Type "X", .187" Hole, .750" Shank L., .594" Head O.D., Black	215	120325B	Snap Rivet Fastener, Male, .170" to .190" Grip, Black	208
120300	Ratchet Rivet Fastener, .750" Head O.D., .235" to .297" Grip, Natural	208	120325C	Snap Rivet Fastener, Male, .170" to .190" Grip, Clear	208
			120327	Snap Rivet Fastener, Male, .220" to .240" Grip, Natural	208
			120327B	Snap Rivet Fastener, Male, .220" to .240" Grip, Black	208
			120327C	Snap Rivet Fastener, Male, .220" to .240" Grip, Clear	208
			120329	Snap Rivet Fastener, Male, .320" to .340" Grip, Natural	208
			120329B	Snap Rivet Fastener, Male, .320" to .340" Grip, Black	208

ITEM #	DESCRIPTION	PAGE #	ITEM #	DESCRIPTION	PAGE #
120329C	Snap Rivet Fastener, Male, .320" to .340" Grip, Clear	208	120418B	Dart (Arrow) Clip Fastener, .250" to .260" Hole Size, .575" L., Black	212
120397	Thumbsnap Fastener, 1/8" Max. Grip, Natural	209	120418C	Dart (Arrow) Clip Fastener, .250" to .260" Hole Size, .575" L., Clear	212
120397B	Thumbsnap Fastener, 1/8" Max. Grip, Black	209	120419	Dart (Arrow) Clip Fastener, .250" to .260" Hole Size, .600" L., Natural	212
120398	Thumbsnap Fastener, 1/4" Max. Grip, Natural	209	120419B	Dart (Arrow) Clip Fastener, .250" to .260" Hole Size, .600" L., Black	212
120398B	Thumbsnap Fastener, 1/4" Max. Grip, Black	209	120420	Dart (Arrow) Clip Fastener, .250" to .260" Hole Size, .810" L., Natural	212
120399B	Heavy Duty Expand-A-Lock, Black	210	120420B	Dart (Arrow) Clip Fastener, .250" to .260" Hole Size, .810" L., Black	212
120399W	Heavy Duty Expand-A-Lock, White	210	120421	Dart (Arrow) Clip Fastener, .250" to .260" Hole Size, 1.135" L., Natural	212
120400	Perf Shelf Dart Clip, White	211	120421B	Dart (Arrow) Clip Fastener, .250" to .260" Hole Size, 1.135" L., Black	212
120400C	Perf Shelf Dart Clip, Clear	211	120422	Perf Shelf Channel Fastener, .875" L., White	211
120401	Viking Clip Fastener - Push On Type, 3/4" Grip, 7/8" L., Clear	209	120422B	Perf Shelf Channel Fastener, .875" L., Black	211
120402B	Viking Clip Fastener - Push On Type, 3/4" Grip, 7/8" L., Black	209	120430	Diamond Hole Shelf Dart Clip, Natural	211
120403	Quick-Grip Washer Fastener, 1/2" Grip, 5/8" L.	209	120430B	Diamond Hole Shelf Dart Clip, Black	211
120404	Quick-Grip Washer Fastener, 3/4" Grip, 7/8" L.	209	120431	Dart Clip - Small, .187" Hole Size, .563" L., Natural	211
120405	Expand-A-Lock Connector, Natural	210	120431B	Dart Clip - Small, .187" Hole Size, .563" L., Black	211
120405B	Expand-A-Lock Connector, Black	210	120433	Pegboard Paper/Vinyl Fastener	209
120406	Viking Clip Fastener - Push On Type, 1-3/8" Grip, 1-1/2" L., Clear	209	120435	Viking Clip Fastener - Push On Type, 7/8" Grip, 1" L., Clear	209
120406B	Viking Clip Fastener - Push On Type, 1-3/8" Grip, 1-1/2" L., Black	209	120450	Perf Shelf Universal Fastener, Low Profile, Natural	210
120407	Perf Shelf Channel Fastener, .500" L., White	211	120450B	Perf Shelf Universal Fastener, Low Profile, Black	210
120407B	Perf Shelf Channel Fastener, .500" L., Black	211	120451	Perf Shelf Universal Fastener, Standard, Natural	210
120410	Dart (Arrow) Clip Fastener, .131" to .135" Hole Size, .390" L., Natural	212	120451B	Perf Shelf Universal Fastener, Standard, Black	210
120410B	Dart (Arrow) Clip Fastener, .131" to .135" Hole Size, .390" L., Black	212	120452	Perf Shelf White Snap Rivet, Natural	210
120411	Stackable Push-In Fastener	212, 283	120452B	Perf Shelf White Snap Rivet, Black	210
120411B	Dart (Arrow) Clip Fastener, .145" to .150" Hole Size, .530" L., Black	212	120455	Easy-Flex Channel Mount Arrow Fastener	124
120412	Dart (Arrow) Clip Fastener, .151" to .161" Hole Size, .400" L., Natural	212	120456	Channel Mount Arrow Fastener, 1/2" L., No Adhesive	124
120412B	Dart (Arrow) Clip Fastener, .151" to .161" Hole Size, .400" L., Black	212	120457	Channel Mount Arrow Fastener, 1/2" L., With Adhesive	124
120413	Dart (Arrow) Clip Fastener, .182" to .192" Hole Size, .400" L., Natural	212	120458	Channel Mount Arrow Fastener, 15/16" L., No Adhesive	124
120413B	Dart (Arrow) Clip Fastener, .182" to .192" Hole Size, .400" L., Black	212	120459	Channel Mount Arrow Fastener, 15/16" L., With Adhesive	124
120414	Dart (Arrow) Clip Fastener, .182" to .192" Hole Size, .518" L., Natural	212	120858	Diamond Hole Shelf Push-In Clip, Natural	211
120414B	Dart (Arrow) Clip Fastener, .182" to .192" Hole Size, .518" L., Black	212	120858B	Diamond Hole Shelf Push-In Clip, Black	211
120415	Dart (Arrow) Clip Fastener, .182" to .192" Hole Size, .550" L., Natural	212	130200	Merchandising Strip With Removable Header	74
120415B	Dart (Arrow) Clip Fastener, .182" to .192" Hole Size, .550" L., Black	212	130201	Versa Merchandising Strip	74
120416	Dart (Arrow) Clip Fastener, .213" to .223" Hole Size, .450" L., Natural	212	130202	Perforated Merchandising Strip	74
120416B	Dart (Arrow) Clip Fastener, .213" to .223" Hole Size, .450" L., Black	212	130203	Metal Merchandising Strips, No Scan Plate, Beige	76
120417	Dart (Arrow) Clip Fastener, .213" to .223" Hole Size, .540" L., Natural	212	130203B	Metal Merchandising Strips, No Scan Plate, Black	76
120417B	Dart (Arrow) Clip Fastener, .213" to .223" Hole Size, .540" L., Black	212	130204	Metal Merchandising Strips, With Scan Plate, Beige	76
120418	Dart (Arrow) Clip Fastener, .250" to .260" Hole Size, .575" L., Natural	212	130204B	Metal Merchandising Strips, With Scan Plate, Black	76

ITEM #	DESCRIPTION	PAGE #
130207	Two-Way Merchandising Strip With Header, White	75
130207B	Two-Way Merchandising Strip With Header, Black	75
130209	Shelf-Top Metal Merchandising Strip, 7 Clips, with Scan Plate	17, 76
130210	Double-Sided Peg Hook Strip	73
130215	Quick-Strip Molded Merchandising Strip With Header, 2" Header W.	75
130216	Quick-Strip Molded Merchandising Strip With Header, 3" Header W.	75
130218	Quick-Strip Molded Merchandising Strip	75
130221	Shelf-Top Metal Merchandising Strip, 12 Clips, with "C" Channel	17, 76
130500	Cable Tie (Locking Strap), .094" W., 4" L., Natural	202
130500B	Cable Tie (Locking Strap), .094" W., 4" L., Black	202
130501	Cable Tie (Locking Strap), .094" W., 6" L., Natural	202
130501B	Cable Tie (Locking Strap), .094" W., 6" L., Black	202
130502	Cable Tie (Locking Strap), .094" W., 8" L., Natural	202
130502B	Cable Tie (Locking Strap), .094" W., 8" L., Black	202
130503	Cable Tie (Locking Strap), .140" W., 5" L., Natural	202
130503B	Cable Tie (Locking Strap), .140" W., 5" L., Black	202
130504	Cable Tie (Locking Strap), .140" W., 8" L., Natural	202
130504B	Cable Tie (Locking Strap), .140" W., 8" L., Black	202
130505	Cable Tie (Locking Strap), .178" W., 7" L., Natural	202
130505B	Cable Tie (Locking Strap), .178" W., 7" L., Black	202
130506	Cable Tie (Locking Strap), .178" W., 11" L., Natural	202
130506B	Cable Tie (Locking Strap), .178" W., 11" L., Black	202
130507	Cable Tie (Locking Strap), .178" W., 14" L., Natural	202
130507B	Cable Tie (Locking Strap), .178" W., 14" L., Black	202
130508	Cable Tie (Locking Strap), .300" W., 8" L., Natural	202
130508B	Cable Tie (Locking Strap), .300" W., 8" L., Black	202
130509	Cable Tie (Locking Strap), .300" W., 15" L., Natural	202
130509B	Cable Tie (Locking Strap), .300" W., 15" L., Black	202
130510	Cable Tie (Locking Strap), .340" W., 24" L., Natural	202
130510B	Cable Tie (Locking Strap), .340" W., 24" L., Black	202
130512	Cable Tie (Locking Strap), .340" W., 36" L., Natural	202
130512B	Cable Tie (Locking Strap), .340" W., 36" L., Black	202
130513	Cable Tie (Locking Strap), .340" W., 48" L., Natural	202
130513B	Cable Tie (Locking Strap), .340" W., 48" L., Black	202
130514	Cable Tie (Locking Strap), .178" W., 17" L., Natural	202

ITEM #	DESCRIPTION	PAGE #
130514B	Cable Tie (Locking Strap), .178" W., 17" L., Black	202
130525	Pole Sign Cable Tie Kit, Natural	201
130525B	Pole Sign Cable Tie Kit, Black	201
130553	Fixed Style Security Tie, 3" L.	203
130555	Fixed Style Security Tie, 5" L.	203
130559	Fixed Style Security Tie, 9" L.	203
130560	Releasable Beaded Locking Straps, 4" L.	202
130561	Releasable Beaded Locking Straps, 6" L.	202
130562	Releasable Beaded Locking Straps, 8" L.	202
130563	Releasable Beaded Locking Straps, 10" L.	202
130565	Loop Style Locking Strap	203
130570	Ladder Style Permanent Locking Straps, 7" L.	203
130571	Ladder Style Permanent Locking Straps, 11" L.	203
130601	Premium Suction Cup - Mushroom Head, 3/4" Dia.	162
130602	Premium Suction Cup - Mushroom Head, 1-1/8" Dia.	162
130603	Premium Suction Cup - Mushroom Head, 1-3/4" Dia.	162
130604	Premium Suction Cup - Mushroom Head, 2-1/2" Dia.	162
130605	Premium Suction Cup - Pilot Hole, 3/4" Dia.	162
130606	Premium Suction Cup - Pilot Hole, 1-1/8" Dia.	162
130607	Premium Suction Cup - Pilot Hole, 1-3/4" Dia.	162
130608	Premium Suction Cup - Pilot Hole, 2-1/2" Dia.	162
130609	Premium Suction Cup - Metal Hook, 3/4" Dia.	162
130610	Premium Suction Cup - Metal Hook, 1-1/8" Dia.	162
130611	Premium Suction Cup - Metal Hook, 1-3/4" Dia.	162
130612	Premium Suction Cup - Metal Hook, 2-1/2" Dia.	162
130613	Suction Cup With Flag Gripper, 1-1/8" Dia.	160
130614	Suction Cup With Flag Gripper, 1-3/4" Dia.	160
130615	Suction Cup With Thumb Screw	163
130616	Suction Cup With Flush Gripper	160
130617	Self-Piercing Suction Cup Flag Sign Holder	161
130618	Suction Cup With Thumbtack	163
130619	Suction Cup With Metal Screw	163
130621	Double Suction Cup With Flag Gripper	160
130623	Clever Clip Suction Cup	159
130630	Economy Suction Cup With Flag Gripper, 1" Cup Dia.	161
130631	Economy Suction Cup With Flag Gripper, 1-3/4" Cup Dia.	161
130632	Economy Suction Cup With Flush Gripper	161
140109	Magnetic Shelf System - Divider	67
140110	Magnetic Shelf System - Divider	67

ITEM #	DESCRIPTION	PAGE #	ITEM #	DESCRIPTION	PAGE #
140111	Magnetic Shelf System – Divider	67	140642	Slim-Line Front Fence	70
140112	Magnetic Shelf System – Divider	67	140658	Double Wire Shelf Info Strip, Clear	34
140113	Magnetic Shelf System – Divider	67	140658W	Double Wire Shelf Info Strip, White	34
140114	Magnetic Shelf System – Divider	67	140659	BetterView Shovel Base Adapter	143
140115	Magnetic Shelf System – Divider	67	140660	BetterView Ratcheting Sign Holder, 3-1/2" H. x 5-1/2" L.	143
140116	Magnetic Shelf System – End Cap	67	140670	Heavy Duty Gripper Sign Holder - Wide, 1" L.	114
140117	Magnetic Shelf System – End Cap	67	140674B	Easel Track Sign Holder, 0" H.	168
140118	Magnetic Shelf System – End Cap	67	140681	Snap-Shut Label Holder For Scan Hook, 3" L.	47
140119	Magnetic Shelf System – End Cap	67	140688	Magnetic Shelf System - Divider	67
140120	Magnetic Shelf System – End Cap	67	140689	Magnetic Shelf System - End Cap	67
140121	Magnetic Shelf System – End Cap	67	140690	Magnetic Shelf System - Front Fence, No Holes	68
140122	Magnetic Shelf System – End Cap	67	140700	BetterView Adapter For Shelf Channel	143
140200	Wall Anchor - Medium Duty Zip-It®, #6 Size, Nylon	222	140701	Center Shelf Mount Covered-Face Sign Holder	127
140201	Wall Anchor - Medium Duty Zip-It®, #8 Size, Nylon	222	140703	Magnetic Shelf System - Front Fence, With Mounting Holes	68
140202	Wall Anchor - Medium Duty Zip-It®, #6 Size, Zinc Alloy	222	140707	Boot System Thin Poster Channel, 24" L.	99
140203	Wall Anchor - Medium Duty Zip-It®, #8 Size, Zinc Alloy	222	140708	Boot System Heavy Duty Gripper Poster Channel, 24" L.	99
140210	Wall Anchor - Light Duty Conical, Blue	222	140709	Boot System Heavy Duty Gripper Poster Channel, 36" L.	99
140211	Wall Anchor - Light Duty Conical, Red	222	140717	Self-Adhesive Info Strip With Guidebar, 29-5/8" L.	28
140214	Toggler® Anchor, 3/8" to 1/2" Capacity	222	140718	BetterView Ratcheting Sign Holder, 1-1/4" H. x 3" L.	143
140215	Toggler® Anchor, 1/8" to 1/4" Capacity	222	140732B	Label Holder For Cooler/Freezer Shelf Channel, 30" L.	30
140216	Toggler® Red Setting Pin (Key)	222	140733B	Label Holder For Cooler/Freezer Shelf Channel, 47-5/8" L.	30
140220	Wall Anchor - Heavy Duty Toggle Wing, 6-32 (1/8") Screw Size	222	140736B	Heavy Duty Self-Adhesive Info Strip, 1-1/2" H., Foam Tape, Black	28
140222	Wall Anchor - Heavy Duty Toggle Wing, 10-24 (3/16") Screw Size	222	140736W	Heavy Duty Self-Adhesive Info Strip, 1-1/2" H., Foam Tape, White	28
140223	Wall Anchor - Heavy Duty Toggle Wing, 1/4-20 (1/4") Screw Size	222	140737	Snap-Shut Label Holder For Scan Hook, 3-1/2" L.	47
140230	Upright Flip Insert, for Pallet Rack	221	140749B	Bucket Clip Track Sign Holder	39, 142
140231	Upright Flip Insert, for Gondola	221	140750B	Channel Mount Track Sign Holder	39
140400	Wobbler - Tapered, 6" L.	135	140752B	Clip-On Track Sign Channel	38
140401	Wobbler - Tapered, 8" L.	135	140758B	Self-Adhesive Track Sign Channel, 5-Track	38
140402	Wobbler - Straight, 4" L.	135	140760B	Track Sign Channel With Bonus Slot, 2-Track, No Tape	38
140403	Wobbler - Straight, 6" L.	135	140765B	Easel Track Sign Holder, 2" H.	168
140411	Aluminum Twist Sign Holder, 3-1/8" L., 3 Pads	134	140771	BetterView Shovel Base Adapter, Angled	143
140412	Aluminum Twist Sign Holder, 6" L., 2 Pads	134	140779B	Angled Tag Molding	36
140413	Aluminum Twist Sign Holder, 6" L., 3 Pads	134	140801B	Track Sign Channel With Bonus Slot, 1-Track, No Tape	38
140415	Wire Basket Round Label Holder	43	140802B	Self-Adhesive Track Sign Channel, 2-Track	38
140501	Channel Wobbler Sign Holder	135	140803B	Track Sign Channel With Bonus Slot, 3-Track, No Tape	38
140620	BetterView Adapter For Wire & Corrugated	143	140830	Plastic Modular Sign Frame System, C-Channel Mount	84
140630	Easel Card Holder - Elevated Angled	168	140834	Metal Sign Frame - Adjustable Stem, Optional Protective Sleeve	86
140633B	Snap-In Info Strip, 1-1/4" H., Black	29			
140634B	Angled Double Wire Shelf Info Strip	34			

ITEM #	DESCRIPTION	PAGE #	ITEM #	DESCRIPTION	PAGE #
140857	R-Clip With Adhesive	25, 139	150014	Magnetic Shelf System – End Cap	67
140858	Narrow Double-Wire Shelf Info Strip, 1-1/2" H., Clear	10, 34	150015	Magnetic Shelf System – End Cap	67
140870B	Track Sign Channel With Bonus Slot, 1-Track, Foam Tape	38	150016	Magnetic Shelf System – End Cap	67
140871	Info Strip Gripper Label Holder For Scan Hook	13, 46	150017	Magnetic Shelf System – End Cap	67
140881	Info Strip Label Holder For Scan Hook, 2-1/2" L., 7 Gauge Wire Size	47	150019B	Grip-On Gripper Info Strip, Black	11, 36
140884	Slim-Line Front Fence, Holes	70	150019W	Grip-On Gripper Info Strip, White	11, 36
140896	Adhesive Wire Grid Sign Holder	25, 139	150022	Clip-On "C" Channel Label Holder, 1-1/4" H.	12, 40
140900	Double "C" Channel With Holes	11, 37	150042	Gripper Display Track, 3/4" Thick Shelf	36
140901	Gripper "H" Clip, 1.175" H. x 3" L.	138	150050	Vinyl Pouch Tag Pocket With Adhesive	171
140909	Pole Gripper Sign Holder, for Medium Poles	200	150051	Vinyl Pouch With Two Mounting Holes	170
140925	Clip-On "C" Channel Label Holder, 1" H.	12, 40	150052	Vinyl Pouch With Side Opening	170
140933B	Narrow Double-Wire Shelf Info Strip, 1-1/4" H., Black	10, 34	150054	Vinyl Pouch With Magnetic Strips	171
140940	Economy "C" Channel Shelf Molding, White	11, 37, 93	150055	Vinyl Pouch With Adhesive, 5-1/2" W. x 3-1/2" H.	171
140940B	Economy "C" Channel Shelf Molding, Black	11, 37, 93	150056	Vinyl Pouch With Adhesive, 11" W. x 8-1/2" H.	171
140960	Info Strip For Glass Shelving	11, 36	150057	Vinyl Pouch With Adhesive, 4" W. x 3" H.	171
140962	C-Channel for Metro Shelving, 1-1/4" H. x 3" L., Gray	12, 40	150058	Vinyl Pouch With Adhesive, 6" W. x 4" H.	171
140962C	C-Channel for Metro Shelving, 1-1/4" H. x 3" L., Clear	12, 40	150061	Vinyl Pouch With Hanging Hole, 4" W. x 6" H.	170
140984B	Shelf-Top Adhesive Info Strip, Black	10, 33	150062	Vinyl Pouch With Hanging Hole, 3" W. x 5" H.	170
140984W	Shelf-Top Adhesive Info Strip, White	10, 33	150105	Literature Pockets, 4" W., 5" H., Flat	174
140989	Plastic Modular Sign Frame System, Stem Connector, White	84	150106	Literature Pockets, 6-1/8" W., 5" H., Flat	174
140989B	Plastic Modular Sign Frame System, Stem Connector, Black	84	150107	Literature Pockets, 8-1/2" W., 7" H., Flat	174
140990	Plastic Modular Sign Frame System, Flat Center Base, White	84	150108	Literature Pockets, 4" W., 5" H., Pre-Formed	174
140990B	Plastic Modular Sign Frame System, Flat Center Base, Black	84	150109	Literature Pockets, 6-1/8" W., 5" H., Pre-Formed	174
140991	Plastic Modular Sign Frame System, Stem Shovel Base, White	84	150110	Literature Pockets, 8-1/2" W., 7" H., Pre-Formed	174
140991B	Plastic Modular Sign Frame System, Stem Shovel Base, Black	84	150112	K-Frame Shovel Base Holder	185
150000	Magnetic Shelf System – Divider	67	150122	Fold-Up Easel Back Literature Box	175
150001	Magnetic Shelf System – Divider	67	150123	Mid-Channel Mount Sign Protectors, 3-1/2" H. x 5-1/2" L.	126
150002	Magnetic Shelf System – Divider	67	150124	Mid-Channel Mount Sign Protectors, 3-1/2" H. x 11" L.	126
150003	Magnetic Shelf System – Divider	67	150130	Fold-Up Rigid Literature Holder	174
150004	Magnetic Shelf System – Divider	67	150131	Single-Pocket Winged Back Literature Holder	175
150005	Magnetic Shelf System – Divider	67	150132	Single-Pocket Winged Back Literature Holder With Hole	175
150006	Magnetic Shelf System – Divider	67	150133	Two-Level Brochure Holder	176
150007	Magnetic Shelf System – Divider	67	150134	Two-Level Winged Back Brochure Holder	176
150009	Slim-Line Sign Protector, 2-1/2" H. x 3-1/2" L.	126	150135	Four-Level Brochure Holder	177
150010	Magnetic Shelf System – End Cap	67	150136	Business Card Holder	173
150011	Magnetic Shelf System – End Cap	67	150137	Extra-Large Winged Back Literature Holder With Hole	176
150012	Magnetic Shelf System – End Cap	67	150138	Two-Way Winged Back Literature Holder	176
150013	Magnetic Shelf System – End Cap	67	150139	Freestanding Sign Holder With Business Card Pocket	178
			150141	Rigid Wall Mount Literature Holder, 6-1/4" W. x 6-1/2" H.	174

ITEM #	DESCRIPTION	PAGE #	ITEM #	DESCRIPTION	PAGE #
150142	Rigid Wall Mount Literature Holder, 9" W. x 9-1/2" H.	174	150195B	Premium Graphic Board Floor Stand, 24" L.	91
150143	Acrylic Top-Load Sign Holder, 8-1/2" W. x 11" H.	179	150196B	Premium Graphic Board Floor Stand, 36" L.	91
150144	Acrylic Top-Load Sign Holder, 11" W. x 8-1/2" H.	179	150197B	Premium Graphic Board Floor Stand, 48" L.	91
150145	T-Style Bottom-Load Sign Holder	178	150198	K-Frame Adjustable Magnetic Rotating Holder	185
150150	Take-One Outdoor Literature Holder, Small	180	150199	K-Frame Shovel Base Adjustable Stem Holder, White	185
150151	Take-One Outdoor Literature Holder, Large	180	150199B	K-Frame Shovel Base Adjustable Stem Holder, Black	185
150153	Multi-Mount Covered-Face Sign Holder	127	150200	Metal Sign Frame - Adjustable Stem, 7" H" x 11" W. Frame, 14" thru 22" Stem H., Chrome	86
150155	Warehouse Upright Adapter	175	150200B	Metal Sign Frame - Adjustable Stem, 7" H. x 11" W. Frame, 14" thru 22" Stem H., Black	86
150157	Clear Display Hanger Strip	135	150201B	Metal Sign Frame - Fixed Stem, 7" H. x 11" W. Frame, 10" H. Stem, Black	86
150160	Slim-Line Sign Protector, 3-1/2" H. x 5-1/2" L.	126	150202B	Metal Sign Frame - Fixed Stem, 5-1/2" H. x 7" W. Frame, 12" H. Stem, Black	86
150161	Slim-Line Dual Mount Sign Protector, 3-1/2" H. x 5-1/2" L.	126	150203B	Metal Sign Frame - Fixed Stem, 7" H. x 11" W. Frame, 12" H. Stem, Black	86
150162	Covered Face Channel With Adhesive	128	150204	Metal Sign Frame - Magnetic Base, 7" H. x 11" W., Chrome Plated	87
150163	Slim-Line Sign Protector, 3" H. x 5" L.	126	150204B	Metal Sign Frame - Magnetic Base, 7" H. x 11" W., Black	87
150164	Slim-Line Sign Protector, 7" H. x 11" L.	126	150205B	Metal Sign Frame - Magnetic Base, 11" H. x 14" W., Black	87
150165	Slantback Fold-Up Sign Holder, 5-1/2" W. x 7" H., Portrait	178	150206B	Metal Sign Frame - No Stem, 7" H. x 11" W. Frame, Wedge Base, Black	86
150166	Slantback Fold-Up Sign Holder, 8-1/2" W. x 11" H., Portrait	178	150207B	Metal Sign Frame - No Stem, 11" H. x 14" W. Frame, Easel Base, Black	86
150167	Slantback Fold-Up Sign Holder, 7" W. x 5-1/2" H., Landscape	178	150209B	Spiral Base Card Holder, 1-3/4" H.	164
150168	Slantback Fold-Up Sign Holder, 11" W. x 8-1/2" H., Landscape	178	150210B	Spiral Base Card Holder, 5" H.	164
150170	Slim-Line Shelf Divider, for 10" Deep Shelf	70	150211B	Spiral Base Card Holder, 7" H.	164
150171	Slim-Line Shelf Divider, for 12" Deep Shelf	70	150212B	Metal Sign Frame - Adjustable Stem, 11" H. x 14" W. Frame, 12" thru 24" Stem H., Black	86
150172	Slim-Line Shelf Divider, for 14" Deep Shelf	70	150213B	Metal Sign Frame - Adjustable Stem, 7" H. x 11" W. Frame, 12" thru 24" Stem H., Black	86
150173	Slim-Line Shelf Divider, for 16" Deep Shelf	70	150214B	Extra Height Adjustable Pallet Sign Holder	89
150174	Slim-Line Shelf Divider, for 18" Deep Shelf	70	150215B	Beverage Shelf Extender	71
150179	K-Frame, 7" x 5-1/2", White	181	150217B	Pallet Sign Holder - Adjustable Height, 11-1/8" H. x 14" W. Frame	88
150179B	K-Frame, 7" x 5-1/2", Black	181	150218B	Pallet Sign Holder - Adjustable Height, 7" H. x 11" W. Frame	88
150180	K-Frame, 4-1/2" x 4-1/2", White	181	150219B	Poster Frame Floor Display Stand	90
150181	K-Frame, 8-1/2" x 5-1/2", White	181	150220	Versa-Tab Coupon Holder	72
150181B	K-Frame, 8-1/2" x 5-1/2", Black	181	150221	Versa-Tab With Butterfly Hole	72
150182	K-Frame, 11" x 7", White	181	150222	Serpentine Metal Shelf Extender	71
150182B	K-Frame, 11" x 7", Black	181	150224	Stainless Steel Pan Clip	145
150183	K-Frame, 11" x 8-1/2", White	181	150225	Snap-Down Metal Sign Frame, 8-1/2" x 11", Silver	85
150184	K-Frame, 5-1/2" x 3-1/2", White	181	150225B	Snap-Down Metal Sign Frame, 8-1/2" x 11", Black	85
150184B	K-Frame, 5-1/2" x 3-1/2", Black	181	150226	Snap-Down Metal Sign Frame, 17" x 22", Silver	85
150185	K-Frame With Adjustable Stem & Base - Plastic, 8-1/2" x 5-1/2"	185	150226B	Snap-Down Metal Sign Frame, 17" x 22", Black	85
150186	K-Frame With Adjustable Stem & Base - Plastic, 11" x 8-1/2"	185	150227	Snap-Down Metal Sign Frame, 22" x 28", Silver	85
150190	Contoured Shelf Divider, 16" L.	68	150227B	Snap-Down Metal Sign Frame, 22" x 28", Black	85
150191	Contoured Shelf Divider, 22" L.	68	150228	Snap-Down Metal Sign Frame, 24" x 36", Silver	85
150192	Anti-Skid Divider, 20" L.	69			
150193	Anti-Skid Divider, 23" L.	69			

ITEM #	DESCRIPTION	PAGE #	ITEM #	DESCRIPTION	PAGE #
150228B	Snap-Down Metal Sign Frame, 24" x 36", Black	85	150305	Heavy Duty Clip-On Extended Knuckle Sign Holder, Clear	156
150231	Outdoor Lawn Sign Frame	91	150305B	Heavy Duty Clip-On Extended Knuckle Sign Holder, Black	156
150232B	Sign Board Pallet Sign Holder — Adjustable Height	88	150306	Suction Cup Clip-On Knuckle Wire Sign Holder	159
150234	Acrylic Slantback Sign Holder, 4" W. x 6" H. Portrait	179	150307	Magnetic Clip-On Knuckle Wire Sign Holder	158
150237B	Plastic Sign Frame — Shovel Base	85	150308	Adhesive Clip-On Knuckle Sign Holder	158
150238B	Plastic Sign Frame — Adjustable Stem	85	150309	Double Clip-On Curly Wire	157
150250	Delta Hole Hang Tab - Bulk	72	150310	Magnetic Clip-On Curly Wire	157
150251	Delta Hole Hang Tab - Sheet Form	72	150311	Clip-On Sign Protector, for 3.5" H. x 5.5" W. Signs	155
150252	Re-Order Hanging Label Holder	73	150312	Clip-On Sign Protector, for 5" H. x 7" W. Signs	155
150253	Re-Order Peg Back Label Holder	73	150313	Clip-On Knuckle Wire Sign Holder	158
150260	Circular Hole Hang Tab - Sheet Form	73	150314	Clip-On Sign Protector, for 2-1/2" H. x 3-3/4" W. Signs	155
150263B	Freestanding Sign Holder With Spring Clip, 3" H.	165	150315	Heavy Duty Telescopic Clip-On Sign Holder	154
150266B	Freestanding Sign Holder With Spring Clip, 6" H.	165	150316	K-Frame Telescopic Clip-On Holder	185
150280	Plastic Modular Sign Frame System, Modular Sign Frame, 8-1/2" x 11", White	84	150317	Spring Clip-On Two-Way Ratcheting Sign Holder	155
150280B	Plastic Modular Sign Frame System, Modular Sign Frame, 8-1/2" x 11", Black	84	150318B	Spring Clip-On Track Sign Holder, 2-Track	39, 144
150281	Plastic Modular Sign Frame System, Modular Sign Frame, 7" x 11", White	84	150319B	Spring Clip-On Track Sign Holder, 1-Track	39, 144
150281B	Plastic Modular Sign Frame System, Modular Sign Frame, 7" x 11", Black	84	150320	Spring Clip-On Rotating Thumb Sign Holder, White	155
150285	Plastic Modular Sign Frame System, Stem-To-Frame Mount, 3" W., White	84	150320B	Spring Clip-On Rotating Thumb Sign Holder, Black	155
150285B	Plastic Modular Sign Frame System, Stem-To-Frame Mount, 3" W., Black	84	150321	K-Frame Spring Clip-On Rotating Thumb Sign Holder	186
150286	Plastic Modular Sign Frame System, Center Stem Base, 4-1/2" x 5-1/2", White	84	150325	Swiveling Clever Clip, White	140
150286B	Plastic Modular Sign Frame System, Center Stem Base, 4-1/2" x 5-1/2", Black	84	150325B	Swiveling Clever Clip, Black	140
150287	Plastic Modular Sign Frame System, Flat Shovel Base, 4-1/2" x 5-1/2", White	84	150326	Swiveling Clever Clip - Jumbo	140
150287B	Plastic Modular Sign Frame System, Flat Shovel Base, 4-1/2" x 5-1/2", Black	84	150327	Slim-Line Dual Mount Sign Protector, 2-1/4" H. x 4-1/4" L.	126
150288	Plastic Modular Sign Frame System, Sign Stem, 4" L., White	84	150349	Wall-Mount Sign Holder, Hook & Loop Backing	172
150288B	Plastic Modular Sign Frame System, Sign Stem, 4" L., Black	84	150351	Wall-Mount Sign Holder, Plain Backing	172
150289	Plastic Modular Sign Frame System, Sign Stem, 8" L., White	84	150354	Solid Contoured Shelf Divider	17, 70
150289B	Plastic Modular Sign Frame System, Sign Stem, 8" L., Black	84	150364	Wall-Mount Sign Holder, Magnetic Backing	172
150300	Double Clip-On Knuckle Sign Holder	157	150366	Slim-Line Sign Protector, 3" H. x 5" L.	126
150301	Spring Clip-On Knuckle Sign Holder, Clear	154	150367	Mini "Stick-On" Tag	10, 31
150301B	Spring Clip-On Knuckle Sign Holder, Black	154	150375	Economy Covered-Face Center Mount Sign Holder, 2-7/8" H. x 4-3/4" L.	127
150302	Spring Clip-On Extended Knuckle Sign Holder, Clear	154	150376	Economy Covered-Face Center Mount Sign Holder, 3-1/2" H. x 7-3/4" L.	127
150302B	Spring Clip-On Extended Knuckle Sign Holder, Black	154	150400B	Metal Sign Frame - Magnetic Base, 14" H. x 11" W., Black	87
150303	Clip-On Knuckle Sign Holder, Clear	156	150401B	Metal Sign Frame - Adjustable Stem, 14" H. x 11" W. Frame, 12" thru 24" Stem H., Black	86
150303B	Clip-On Knuckle Sign Holder, Black	156	150403B	Metal Sign Frame - Fixed Stem, 7" H. x 11" W. Frame, 14" H. Stem, Black	86
150304	Heavy Duty Clip-On Knuckle Sign Holder, Clear	156	150404B	Floor Stand With Sign Frame & Bag Stem	89
150304B	Heavy Duty Clip-On Knuckle Sign Holder, Black	156	150405B	Floor Stand With Welded Top Sign	89
			150406B	Floral Stand With Bucket Holder	18, 81
			150408B	Spiral Base Card Holder, 3-1/2" H.	164

ITEM #	DESCRIPTION	PAGE #	ITEM #	DESCRIPTION	PAGE #
150409B	Track Sign Holders With Ratcheting Heads, Magnetic Base	141	150511B	Hook & Loop Fastener, Tape, 2" Loop, Black	219
150412B	Track Sign Holders With Ratcheting Heads, Sloping Base	141	150602	Hook & Loop Fastener, Coins, 1/2" Hook, White	219
150413B	Track Sign Holders With Ratcheting Heads, Shovel Base	141	150602B	Hook & Loop Fastener, Coins, 1/2" Hook, Black	219
150414B	Track Sign Holders With Ratcheting Heads, Plain Base	141	150603	Hook & Loop Fastener, Coins, 1/2" Loop, White	219
150417	Business Card Holder For Pegboard/Slatwall	26, 173	150603B	Hook & Loop Fastener, Coins, 1/2" Loop, Black	219
150418B	Produce Bin Overhanging Sign Frame, 14" H. x 11" W., Fits 3/8" Thick Edge	142	150606	Hook & Loop Fastener, Coins, 3/4" Hook, White	219
150420B	Track Sign Holders With Ratcheting Heads, Rotating Thumb Clamp Base	141	150606B	Hook & Loop Fastener, Coins, 3/4" Hook, Black	219
150421	Newspaper & Ad Stand Sign Holder	90	150607	Hook & Loop Fastener, Coins, 3/4" Loop, White	219
150423	Harp Clip Sign Holder, 8" H.	164	150607B	Hook & Loop Fastener, Coins, 3/4" Loop, Black	219
150424	Harp Clip Sign Holder, 6" H.	164	150608	Hook & Loop Fastener, Coins, 7/8" Hook, White	219
150426B	Spiral Cone Card Holder	165	150608B	Hook & Loop Fastener, Coins, 7/8" Hook, Black	219
150428	Harp Clip Sign Holder, 1-1/2" H.	164	150609	Hook & Loop Fastener, Coins, 7/8" Loop, White	219
150429B	Metal Sign Frame - Fixed Stem, 5-1/2" H. x 7" W. Frame, 8" H. Stem, Black	86	150609B	Hook & Loop Fastener, Coins, 7/8" Loop, Black	219
150430B	Weighted Base Sign Holder With Gripper, 6" H.	165	150625	Corrugated Edge Molding, Chrome	190
150431B	Weighted Base Sign Holder With Gripper, 3" H.	165	150625B	Corrugated Edge Molding, Black	190
150434B	Produce Bin Overhanging Sign Frame, 2-1/2" H. x 7" W., Fits 1" Thick Edge	142	150625W	Corrugated Edge Molding, White	190
150435B	Produce Bin Overhanging Sign Frame, 2-1/2" H. x 7" W., Fits 1-3/8" Thick Edge	142	150650	Bumper Buttons, .060" H., Clear	221
150436B	Produce Bin Overhanging Sign Frame, 11" H. x 7" W., Fits 1-1/2" Thick Edge	142	150650B	Bumper Buttons, .060" H., Black	221
150439	Basket For Newspaper & Ad Stand Sign Holder	90	150651	Bumper Buttons, .140" H., Clear	221
150464B	Universal Pallet Floor Sign Holder, 5" H. x 7" W.	20, 88	150651B	Bumper Buttons, .140" H., Black	221
150465B	Universal Pallet Floor Sign Holder, 7" H. x 11" W.	20, 88	150675	Foam Block Stand-Off	221, 284
150466B	Universal Pallet Floor Sign Holder, 8-1/2" H. x 11" W.	20, 88	150680	Double-Sided Pre-Cut Foam Tape, 1/2" W. x 1" L., Permanent	220
150482	Clear Tabletop Bin	18, 82	150681	Double-Sided Pre-Cut Foam Tape, 3/4" W. x 2-3/4" L., Permanent	220
150502	Hook & Loop Fastener, Tape, 5/8" Hook, White	219	150682	Double-Sided Pre-Cut Foam Tape, 1/2" W. x 1" L., Removable	220
150502B	Hook & Loop Fastener, Tape, 5/8" Hook, Black	219	150683	Double-Sided Pre-Cut Foam Tape, 3/4" W. x 2-3/4" L., Removable	220
150503	Hook & Loop Fastener, Tape, 5/8" Loop, White	219	150684	Double-Sided Pre-Cut Foam Tape, 1" W. x 1" L., Removable	220
150503B	Hook & Loop Fastener, Tape, 5/8" Loop, Black	219	150703B	Goose Neck Telescopic Sign Holder With Spring Clip	26, 164
150504	Hook & Loop Fastener, Tape, 3/4" Hook, White	219	150706B	Freestanding Sign Holder With Spring Clip, 3" H. x 2" base O.D.	165
150504B	Hook & Loop Fastener, Tape, 3/4" Hook, Black	219	150707B	Weighted Base Flat Sign Holder	26, 165
150505	Hook & Loop Fastener, Tape, 3/4" Loop, White	219	150801	Acrylic Slantback Sign Holder, 5-1/2" W. x 3-1/2" H. Landscape	179
150505B	Hook & Loop Fastener, Tape, 3/4" Loop, Black	219	150802	Acrylic Slantback Sign Holder, 7" W. x 5-1/2" H. Landscape	179
150506	Hook & Loop Fastener, Tape, 1" Hook, White	219	150803	Acrylic Slantback Sign Holder, 8-1/2" W. x 11" H. Portrait	179
150506B	Hook & Loop Fastener, Tape, 1" Hook, Black	219	150805	Acrylic Slantback Sign Holder, 11" W. x 7" H. Landscape	179
150507	Hook & Loop Fastener, Tape, 1" Loop, White	219	150808	Acrylic Slantback Sign Holder, 11" W. x 8-1/2" H. Landscape	179
150507B	Hook & Loop Fastener, Tape, 1" Loop, Black	219	150810	T-Style Sign Holder With Pocket	177
150510	Hook & Loop Fastener, Tape, 2" Hook, White	219	150811	Rigid Wall Mount Coupon Holder	173
150510B	Hook & Loop Fastener, Tape, 2" Hook, Black	219	150822	Acrylic Top-Load Sign Holder, 4" W. x 5-1/2" H.	179
150511	Hook & Loop Fastener, Tape, 2" Loop, White	219	150825	Acrylic Slantback Sign Holder, 11" W. x 7" H. with Elongated Base	179

ITEM #	DESCRIPTION	PAGE #
150826	Rigid Freestanding Literature Holder	174
150831	Three-Level Brochure Holder	177
150833	T-Style Sign Holder With Business Card Pocket	178
150837	Acrylic Top-Load Sign Holder, 5-1/2" W. x 7" H.	179
150841	T-Style Bottom-Load Sign Holder, 9" W. x 12" H.	178
150903B	Channel Mount Swivel Gripper, up to .100" Grip	101
150904B	Channel Mount Swivel Gripper, .100" to .250" Grip	101
150960	Vented Bin For Glass	19, 82
150967C	C-Channel for Metro Shelving, 1-1/4" H. x 44-1/4" L., Clear	12, 40
150968	Label Holder For Opti-Bin	19, 82
160244	Single Prong Metal Grid Hook, 4" L.	54
160246	Single Prong Metal Grid Hook, 6" L.	54
160248	Single Prong Metal Grid Hook, 8" L.	54
160540	Single Prong All-Wire Pegboard Hook, .212" Dia., 10" L.	51
160542	Single Prong All-Wire Pegboard Hook, .212" Dia., 12" L.	51
160544	Single Prong All-Wire Pegboard Hook, .212" Dia., 4" L.	51
160546	Single Prong All-Wire Pegboard Hook, .212" Dia., 6" L.	51
160548	Single Prong All-Wire Pegboard Hook, .212" Dia., 8" L.	51
160570	Single Prong All-Wire Pegboard Hook, .186" Dia., 10" L.	51
160572	Single Prong All-Wire Pegboard Hook, .186" Dia., 12" L.	51
160574	Single Prong All-Wire Pegboard Hook, .186" Dia., 4" L.	51
160576	Single Prong All-Wire Pegboard Hook, .186" Dia., 6" L.	51
160578	Single Prong All-Wire Pegboard Hook, .186" Dia., 8" L.	51
160594	Single Prong All-Wire Pegboard Hook, .149" Dia., 4" L.	51
160596	Single Prong All-Wire Pegboard Hook, .149" Dia., 6" L.	51
160598	Single Prong All-Wire Pegboard Hook, .149" Dia., 8" L.	51
160640	All-Wire Pegboard Hook With Scan Hook, .212" Dia., 10" L.	50
160642	All-Wire Pegboard Hook With Scan Hook, .212" Dia., 12" L.	50
160646	All-Wire Pegboard Hook With Scan Hook, .212" Dia., 6" L.	50
160648	All-Wire Pegboard Hook With Scan Hook, .212" Dia., 8" L.	50
160674	All-Wire Pegboard Hook With Scan Hook, .186" Dia., 4" L.	50
160676	All-Wire Pegboard Hook With Scan Hook, .186" Dia., 6" L.	50
160678	All-Wire Pegboard Hook With Scan Hook, .186" Dia., 8" L.	50
160740	All-Wire Pegboard Hook With Scan Plate, .212" Dia., 10" L.	50

ITEM #	DESCRIPTION	PAGE #
160742	All-Wire Pegboard Hook With Scan Plate, .212" Dia., 12" L.	50
160744	All-Wire Pegboard Hook With Scan Plate, .212" Dia., 4" L.	50
160746	All-Wire Pegboard Hook With Scan Plate, .212" Dia., 6" L.	50
160748	All-Wire Pegboard Hook With Scan Plate, .212" Dia., 8" L.	50
160774	All-Wire Pegboard Hook With Scan Plate, .186" Dia., 4" L.	50
160776	All-Wire Pegboard Hook With Scan Plate, .186" Dia., 6" L.	50
160778	All-Wire Pegboard Hook With Scan Plate, .186" Dia., 8" L.	50
160840	Speedy-Back Metal Peg Hook With Scan Hook, .212" Dia., 10" L.	51
160842	Speedy-Back Metal Peg Hook With Scan Hook, .212" Dia., 12" L.	51
160844	Speedy-Back Metal Peg Hook With Scan Hook, .212" Dia., 4" L.	51
160846	Speedy-Back Metal Peg Hook With Scan Hook, .212" Dia., 6" L.	51
160848	Speedy-Back Metal Peg Hook With Scan Hook, .212" Dia., 8" L.	51
160874	Speedy-Back Metal Peg Hook With Scan Hook, .186" Dia., 4" L.	51
160876	Speedy-Back Metal Peg Hook With Scan Hook, .186" Dia., 6" L.	51
160878	Speedy-Back Metal Peg Hook With Scan Hook, .186" Dia., 8" L.	51
161040	Speedy-Back Metal Peg Hook With T-Scan Bar, .212" Dia., 10" L.	52
161042	Speedy-Back Metal Peg Hook With T-Scan Bar, .212" Dia., 12" L.	52
161044	Speedy-Back Metal Peg Hook With T-Scan Bar, .212" Dia., 4" L.	52
161046	Speedy-Back Metal Peg Hook With T-Scan Bar, .212" Dia., 6" L.	52
161048	Speedy-Back Metal Peg Hook With T-Scan Bar, .212" Dia., 8" L.	52
161074	Speedy-Back Metal Peg Hook With T-Scan Bar, .186" Dia., 4" L.	52
161076	Speedy-Back Metal Peg Hook With T-Scan Bar, .186" Dia., 6" L.	52
161078	Speedy-Back Metal Peg Hook With T-Scan Bar, .186" Dia., 8" L.	52
161140	All-Wire Pegboard Hook With T-Scan Bar, .212" Dia., 10" L.	50
161142	All-Wire Pegboard Hook With T-Scan Bar, .212" Dia., 12" L.	50
161148	All-Wire Pegboard Hook With T-Scan Bar, .212" Dia., 8" L.	50
161170	All-Wire Pegboard Hook With T-Scan Bar, .186" Dia., 10" L.	50
161174	All-Wire Pegboard Hook With T-Scan Bar, .186" Dia., 4" L.	50
161176	All-Wire Pegboard Hook With T-Scan Bar, .186" Dia., 6" L.	50
161178	All-Wire Pegboard Hook With T-Scan Bar, .186" Dia., 8" L.	50
161240	Single Prong Plastic Back Metal Pegboard Hook, .212" Dia., 10" L.	53
161242	Single Prong Plastic Back Metal Pegboard Hook, .212" Dia., 12" L.	53

ITEM #	DESCRIPTION	PAGE #	ITEM #	DESCRIPTION	PAGE #
161244	Single Prong Plastic Back Metal Pegboard Hook, .212" Dia., 4" L.	53	220004	Threaded Extension Pole, 4 ft. Ext. L.	264
161246	Single Prong Plastic Back Metal Pegboard Hook, .212" Dia., 6" L.	53	220005W	Banner Hanger Track End Cap Retainer	248, 289
161248	Single Prong Plastic Back Metal Pegboard Hook, .212" Dia., 8" L.	53	220010	Threaded Extension Pole, 10 ft. Ext. L.	264
161270	Single Prong Plastic Back Metal Pegboard Hook, .186" Dia., 10" L.	53	220018	Threaded Extension Pole, 18 ft. Ext. L.	264
161272	Single Prong Plastic Back Metal Pegboard Hook, .186" Dia., 12" L.	53	220020	K-Stick Ladderless Pole, 4 ft. Ext. L.	277
161274	Single Prong Plastic Back Metal Pegboard Hook, .186" Dia., 4" L.	53	220022	K-Stick Ladderless Pole, 10 ft. Ext. L.	277
161276	Single Prong Plastic Back Metal Pegboard Hook, .186" Dia., 6" L.	53	220024	K-Stick Ladderless Pole, 18 ft. Ext. L.	277
161278	Single Prong Plastic Back Metal Pegboard Hook, .186" Dia., 8" L.	53	220025	Installation Poles, 10 ft. Ext. L.	264
161402	Curl Back Crossbar Hook	13, 54	220027	Installation Poles, 18 ft. Ext. L.	264
170966	Opti-Bin, 7-1/2" Long	19, 82	220033	360 Degree Trapeze Banner Hanger Adapter Kit	287
170967	Opti-Bin, 9-1/2" Long	19, 82	220070	Magnetic Ladderless Ceiling Clip With Holes	280
170968	Opti-Bin, 11-1/2" Long	19, 82	220071	Magnetic Ladderless Ceiling Clothes Hanger Adapter	281
180029	Synthetic Wicker Basket	19, 82	220075	Magnetic Ladderless Ceiling Clip & Cord, 10 ft., White	280
180031B	Three-Level Merchandise Floor Bin	17, 81	220075C	Magnetic Ladderless Ceiling Clip & Cord, 10 ft., Clear	280
180200	Universal Crossbar, 1-3/8" x 1" x 48"	14, 54	220080	Ladderless "C" Channel Clip & Cord, 10 ft., White, Standard	288
181518	Wire Power Wing, Beige	18, 81	220080C	Ladderless "C" Channel Clip & Cord, 10 ft., Clear, Standard	288
181518S	Wire Power Wing, Silver	18, 81	220085	Ladderless "C" Channel Clip & Cord, 10 ft., White, Heavy Duty	288
181522	J-Clip Hardware Kit for Wire Power Wing	18, 81	220100	Ladderless Multi-Use Hanger Clip	289
187112	Square Graphic/Banner End Cap	244	220112	Ladderless Mounting Plate Stud Screw, Zinc Plated Head	290
187561	Square Graphic/Banner Hanger Clip	244	220112W	Ladderless Mounting Plate Stud Screw, White Head	290
200009	Security Peg Back Lock	14, 15, 64	220114	Ladderless Toggle Screw Mounting Plate Anchor, Zinc Plated Head	290
200010	Take-One Metal Hook With T-Scan Bar, 10" L.	15, 64	220114W	Ladderless Toggle Screw Mounting Plate Anchor, White Head	290
200016	Take-One Metal Hook With T-Scan Bar, 6" L.	15, 64	220115	Ladderless Mounting Plate, Zinc Plated	290
200018	Take-One Metal Hook With T-Scan Bar, 8" L.	15, 64	220115W	Ladderless Mounting Plate, White	290
200020	Anti-Sweep Metal Hook With T-Scan Bar, 10" L.	14, 64	220121	Ladderless Mounting Strip, 26" L.	288
200026	Anti-Sweep Metal Hook With T-Scan Bar, 6" L.	14, 64	220122	Ladderless Mounting Strip, 36" L.	288
200028	Anti-Sweep Metal Hook With T-Scan Bar, 8" L.	14, 64	220123	Ladderless Mounting Strip, 48" L.	288
200030B	K-Lock Security Tether, Standard Duty, Grommet End	16, 66	220151	Ladderless Mounting Plate Hardware Kit, One Set Per Kit, Zinc Plated	291
200031B	K-Lock Security Tether, Standard Duty, Loop End	16, 66	220151W	Ladderless Mounting Plate Hardware Kit, One Set Per Kit, White	291
200032B	K-Lock Security Tether, Standard Duty, Collar End	16, 66	220152	Ladderless Mounting Plate Hardware Kit, Two Sets Per Kit, Zinc Plated	291
200033B	K-Lock Security Tether, Standard Duty, Round End	16, 66	220152W	Ladderless Mounting Plate Hardware Kit, Two Sets Per Kit, White	291
200034B	K-Lock Security Tether, Standard Duty, Flex End	16, 66	220153	Ladderless Mounting Plate Hardware Kit, Three Sets Per Kit, Zinc Plated	291
200035B	K-Lock Security Tether, Standard Duty, Ball End	16, 66	220153W	Ladderless Mounting Plate Hardware Kit, Three Sets Per Kit, White	291
219011	Round Graphic/Banner End Cap	242	220154	Ladderless Mounting Plate Hardware Kit, Four Sets Per Kit, Zinc Plated	291
			220154W	Ladderless Mounting Plate Hardware Kit, Four Sets Per Kit, White	291

ITEM #	DESCRIPTION	PAGE #	ITEM #	DESCRIPTION	PAGE #
220155	Ladderless Mounting Plate Hardware Kit, Five Sets Per Kit, Zinc Plated	291	220512	Ladderless Hook Banner Hanger, 26" L., Standard Hook	286
220155W	Ladderless Mounting Plate Hardware Kit, Five Sets Per Kit, White	291	220513	Ladderless Hook Banner Hanger, 36" L., Standard Hook	286
220175	Ladderless Drill Bits, 7/32" Dia. x 3-3/4" L.	291	220516	Ladderless Magnetic Atlas Wall Banner Hanger, 48" L.	282
220176	Ladderless Drill Bits, 1/2" Dia. x 6" L.	291	220517	Ladderless Magnetic Banner Hanger - Heavy Duty, 14" L.	278
220191	Adjustable Trapeze Banner Hanger System, 4 ft. Support Tube	250, 287	220519	Ladderless Hook Banner Hanger - Heavy Duty, Standard Hook	286
220193	Adjustable Trapeze Banner Hanger System, 6 ft. Support Tube	250, 287	220521	Ladderless Magnetic "C" Channel Banner Hanger, 26" L.	279
220197	Adjustable Trapeze Banner Hanger System, 10 ft. Support Tube	250, 287	220522	Ladderless Magnetic "C" Channel Banner Hanger, 36" L.	279
220200	Plastic Banner Dowel Rod, 48" L.	248, 288	220523	Ladderless Magnetic "C" Channel Banner Hanger, 48" L.	279
220201	Plastic Banner Dowel Rod, 24" L.	248, 288	220527	Ladderless Magnetic Atlas Banner Hanger, 26" L.	280
220202	Plastic Banner Dowel Rod, 26" L.	248, 288	220528	Ladderless Magnetic Atlas Banner Hanger, 36" L.	280
220203	Plastic Banner Dowel Rod, 36" L.	248, 288	220529	Ladderless Magnetic Atlas Banner Hanger, 48" L.	280
220204	Plastic Double "C" Hooks - Open Ends, 4" L.	256	220531	Ladderless 360 Degree Magnetic Banner Hanger, 14" L.	278
220206	Plastic Double "C" Hooks - Open Ends, 6" L.	256	220532	Ladderless 360 Degree Magnetic Banner Hanger, 26" L.	278
220208	Plastic Double "C" Hooks - Open Ends, 8" L.	256	220533	Ladderless 360 Degree Magnetic Banner Hanger, 36" L.	278
220212	Plastic Double "C" Hooks - Open Ends, 12" L.	256	220536	Ladderless 360 Degree Hook Banner Hanger, 26" L., Standard Hook	286
220216	Plastic Double "C" Hooks - Open Ends, 16" L.	256	220537	Ladderless 360 Degree Hook Banner Hanger, 36" L., Standard Hook	286
220220	Vinyl Graphic Banner Hanger Track, 24" L.	248	220546	Ladderless Magnetic Gripper Apollo Wall Banner Hanger, 26" L.	282
220221	Vinyl Graphic Banner Hanger Track, 26" L.	248	220547	Ladderless Magnetic Gripper Apollo Wall Banner Hanger, 36" L.	282
220222	Vinyl Graphic Banner Hanger Track, 36" L.	248	220548	Ladderless Magnetic Gripper Apollo Wall Banner Hanger, 48" L.	282
220223	Vinyl Graphic Banner Hanger Track, 48" L.	248	220551	Ladderless Magnetic Gripper Apollo Banner Hanger, 26" L.	279
220225	Vinyl Graphic Banner Hanger Track, 72" L.	248	220552	Ladderless Magnetic Gripper Apollo Banner Hanger, 36" L.	279
220250	Ladderless End Hooks, 4-1/4" L.	289	220553	Ladderless Magnetic Gripper Apollo Banner Hanger, 48" L.	279
220251	Ladderless End Hooks, 16" L.	289	220556	Ladderless Magnetic "C" Channel Wall Banner Hanger, 26" L.	281
220252	Ladderless End Hooks, 12" L.	289	220557	Ladderless Magnetic "C" Channel Wall Banner Hanger, 36" L.	281
220306	Plastic Double "C" Hooks - Locking Ends, 6" L.	256	220558	Ladderless Magnetic "C" Channel Wall Banner Hanger, 48" L.	281
220312	Plastic Double "C" Hooks - Locking Ends, 12" L.	256	220561	Ladderless Magnetic Gripper Banner Hanger, 26" L.	279
220318	Plastic Double "C" Hooks - Locking Ends, 18" L.	256	220562	Ladderless Magnetic Gripper Banner Hanger, 36" L.	279
220480	Ladderless Hook Banner Hanger, 26" L., Mini Hook	286	220563	Ladderless Magnetic Gripper Banner Hanger, 48" L.	279
220481	Ladderless Hook Banner Hanger, 36" L., Mini Hook	286	220572	Ladderless Magnetic Gripper Wall Banner Hanger, 26" L.	282
220485	Ladderless 360 Degree Hook Banner Hanger, 26" L., Mini Hook	286	220573	Ladderless Magnetic Gripper Wall Banner Hanger, 36" L.	282
220486	Ladderless 360 Degree Hook Banner Hanger, 36" L., Mini Hook	286	220574	Ladderless Magnetic Gripper Wall Banner Hanger, 48" L.	282
220489	Ladderless Hook Banner Hanger - Heavy Duty, Mini Hook	286	220601C	Ladderless Cleat Banner Hanger For Glass, Suction Cup Track, 22" L.	285
220503	Ladderless Magnetic Atlas Wall Banner Hanger, 26" L.	282	220602C	Ladderless Cleat Banner Hanger For Glass, Suction Cup Track, 24" L.	285
220504	Ladderless Magnetic Atlas Wall Banner Hanger, 36" L.	282			
220507	Ladderless Magnetic Banner Hanger, 14" L.	278			
220508	Ladderless Magnetic Banner Hanger, 26" L.	278			
220509	Ladderless Magnetic Banner Hanger, 36" L.	278			

ITEM #	DESCRIPTION	PAGE #	ITEM #	DESCRIPTION	PAGE #
220604C	Ladderless Cleat Banner Hanger For Glass, Suction Cup Track, 36" L.	285	220670	Ladderless "C" Channel Cleat Wall Banner Hanger, 48" L., "C" Channel Banner Hanger	285
220605C	Ladderless Cleat Banner Hanger For Glass, Suction Cup Track, 48" L.	285	220672	Ladderless "C" Channel Cleat Wall Banner Hanger, 72" L., "C" Channel Banner Hanger	285
220606C	Ladderless Cleat Banner Hanger For Glass, Atlas Banner Hanger, 22" L.	285	411203	Round Graphic/Banner Hanger Clip	242
220607C	Ladderless Cleat Banner Hanger For Glass, Atlas Banner Hanger, 24" L.	285	411205	Conduit Support Tube Hanging Clip	250
220609C	Ladderless Cleat Banner Hanger For Glass, Atlas Banner Hanger, 36" L.	285	411211	Wooden Banner Dowel Rods, 36" L., 3/8" Dia.	249
220610C	Ladderless Cleat Banner Hanger For Glass, Atlas Banner Hanger, 48" L.	285	411215	Wooden Banner Dowel Rods, 36" L., 1/2" Dia.	249
220626	Ladderless Stackable "C" Channel Sign Board	283	411216	Wooden Banner Dowel Rods, 48" L., 1/2" Dia.	249
220631	Ladderless Binder Cleat Wall Banner Hanger, 24" L., Binder Banner Hanger	284	411221	Wooden Banner Dowel Rods, 48" L., 3/4" Dia.	249
220632	Ladderless Binder Cleat Wall Banner Hanger, 36" L., Binder Banner Hanger	284	411230	Wooden Banner Dowel End Cap, for 3/8" Dia. Dowel Rods, White	249
220633	Ladderless Binder Cleat Wall Banner Hanger, 48" L., Binder Banner Hanger	284	411230B	Wooden Banner Dowel End Cap, for 3/8" Dia. Dowel Rods, Black	249
220635	Ladderless Binder Cleat Wall Banner Hanger, 72" L., Binder Banner Hanger	284	411231	Wooden Banner Dowel End Cap, for 1/2" Dia. Dowel Rods, White	249
220641	Ladderless Binder Cleat Wall Banner Hanger, 24" L., Wall Mount Track	284, 285	411231B	Wooden Banner Dowel End Cap, for 1/2" Dia. Dowel Rods, Black	249
220642	Ladderless Binder Cleat Wall Banner Hanger, 36" L., Wall Mount Track	284, 285	411232	Wooden Banner Dowel End Cap, for 3/4" Dia. Dowel Rods, White	249
220643	Ladderless Binder Cleat Wall Banner Hanger, 48" L., Wall Mount Track	284, 285	411232B	Wooden Banner Dowel End Cap, for 3/4" Dia. Dowel Rods, Black	249
220645	Ladderless Binder Cleat Wall Banner Hanger, 72" L., Wall Mount Track	284, 285	411236	Wooden Banner Dowel Joiner, for 1/2" Dia. Dowel Rods	249
220651	Ladderless Stackable Spiral Sign Board	283	411237	Wooden Banner Dowel Joiner, for 3/4" Dia. Dowel Rods	249
220668	Ladderless "C" Channel Cleat Wall Banner Hanger, 24" L., "C" Channel Banner Hanger	285	411240	Wooden Banner Dowel Screw Eye	249
220669	Ladderless "C" Channel Cleat Wall Banner Hanger, 36" L., "C" Channel Banner Hanger	285	707100	Hex Wrench for Heavy Duty Round Graphic/Banner Joiner	243
			707205	Heavy Duty Round Graphic/Banner Joiner	243

CUSTOM SOLUTIONS. SOLVED.

In-House Capabilities:

Custom Design Services | 3D Prototyping

High Speed Polybagging | Boxing | Labeling | Bar Coding | Instruction Sheets
 Custom Plastic Extrusions | Injection Molding | Hook & Loop Cutting & Mating
 Cable & Chain Cutting | Custom Cable Assemblies | Cable Crimping & Spooling
 Dyeing of Nylon Parts | Painting of Plastic & Metal Parts for Exact Color Matches
 Plating of Metal Parts | Anodizing of Aluminum Hardware | Conduit & Tubing Cutting
 Metal Drilling | Metal Bending | Metal Cutting | Metal Threading | Much, Much More...

Terms of Sale

- Minimum order amount is \$150.00.
- We accept Visa, MasterCard, American Express and Discover credit cards at time of shipment. For use of credit cards after time of shipment, we reserve the right to charge a 3% “convenience fee” to cover the additional cost associated with credit card transactions.
- Invoice terms: Net 30 (with prior credit approval).
- Terms of payment are effective from date of invoice.
- An interest charge of 1.5% per month is applied to all late overdue invoices.
- All pricing is subject to change without prior notification.
- Kinter reserves the right to revise the quoted price or add a surcharge line to an invoice to adjust for the impact of any tariff rate changes.
- Shipping within 24 hours is possible only for in-stock catalog items that require no secondary operations, and only if the order is placed via phone by 3:00 CST.
- Large quantity orders may be split into two delivery dates (up to 90 days apart maximum).
- Blanket ship dates may be changed one time for a maximum of 60 additional days.
- For custom made, non-stocking products we reserve the right to fulfill the order with a final quantity of 10% above the ordered quantity.
- We offer free samples on most of the items listed in our catalog; however, we have the right to charge when necessary.
- We reserve the right to change or improve products without notice.

Return Policy

- All damage or shortage claims must be made within 10 days of ship date. Failure to notify us within 10 days of shipment will constitute the acceptance of the shipment.
- No returns granted without prior return authorization number given.
- Unauthorized returns will not be received.
- Customers are responsible for all freight charges related to returns.
- A restock charge of 20% applies to all authorized returns and/or cancellations of catalog items.
- Production run quantities of a catalog item are returnable, subject to our current inventory levels and needs.
- No returns after 30 days from date of shipment.
- No returns on any special work items (i.e. bagged/kitted items, painted items, dyed items, plated items, non-catalog items, custom made items, etc.)
- No returns on items that have been damaged or altered by customer.

Shipping Information

- F.O.B. is Waukegan, Illinois, USA.
- We can drop ship to two separate locations at no charge. A drop ship charge would apply to orders with more than two locations.
- If product is damaged by a freight carrier, please notify the carrier immediately and mark the bill of lading as “damaged.” Please then file a claim with the carrier.
- Customers are liable for any costs related to rejected collect freight charges wherein Kinter (K International, Inc.) is not at fault.

Liability Notice

- Purchaser assumes all risk of liability and damages due to the improper use of our products.
- It is the responsibility of those who purchase from us, and/or their customers who apply our products, to select the proper part and to test those parts at a level that is commensurate with the nature of the application.
- Kinter (K International, Inc.) is not responsible, nor assumes any risk or liability whatsoever, in connection with the products, or combination of the products, contained within.
- Kinter makes no warranty, expressed or implied, of any kind related to the use of our products.
- Claims against Kinter shall be limited to a refund or credit for the price billed or paid for improper merchandise.
- Kinter shall not be responsible for buyer's manufacturing costs, labor, alternate purchases, extra freight, plating, re-plating, lost profit, good will, recall costs or other incidental or consequential damages.
- There are no understandings, agreements, representations, or warranties, expressed or implied (including any regarding warranties of merchantability or fitness for a particular purpose), not specified herein, respecting any sale of products by Kinter (to the extent permitted by law).
- Any merchandise and/or signage shown within Kinter's product catalogs or on a Kinter website is for demonstration only – no endorsement is expressed or implied.

(All above items are subject to change without notice.)

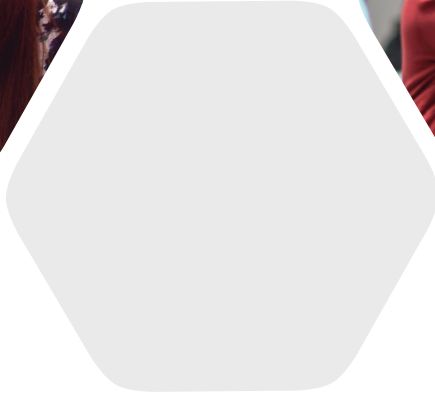

We Are **Family**

At Kinter, family extends beyond those who own our company; it encompasses our employees and customers alike. With our collective focus on your business objectives, there is no challenge too great, and nothing we can't conquer together. So, whenever you have a retail display hardware challenge and need a unique solution or a bright new idea, we'll be right here waiting for you.



Kinter[®]

switch. save. solved.



Visit Our Site Today!



800-323-2389 | kinter.com

3333 Oak Grove Ave. Waukegan, IL 60087